

PLEASE CHECK WWW.MOLEX.COM FOR LATEST PART INFORMATION

Part Number: [0022057095](#)
Status: **Active**
Overview: [Mini-SPOX Wire-to-Board Connector System](#)
Description: 2.50mm Pitch Mini-SPOX Wire-to-Board Header, Right-Angle, Shrouded, Friction Lock, 9 Circuits

Documents:

[3D Model](#) [Packaging Specification SPK-5268-001-001 \(PDF\)](#)
[Drawing \(PDF\)](#) [RoHS Certificate of Compliance \(PDF\)](#)
[Product Specification PS-5264-001-001 \(PDF\)](#)

Agency Certification

CSA LR19980
 UL E29179

General

Product Family PCB Headers
 Series [5268](#)
 Application Signal, Wire-to-Board
 Overview [Mini-SPOX Wire-to-Board Connector System](#)
 Product Name Mini-SPOX
 UPC 800753592841

Physical

Breakaway No
 Circuits (Loaded) 9
 Circuits (maximum) 9
 Color - Resin Natural
 Durability (mating cycles max) 30
 First Mate / Last Break No
 Flammability 94V-0
 Glow-Wire Capable No
 Guide to Mating Part No
 Keying to Mating Part None
 Lock to Mating Part Yes
 Material - Plating Mating Tin
 Material - Plating Termination Tin
 Material - Resin Nylon
 Net Weight 897.600/mg
 Number of Rows 1
 Orientation Right Angle
 PC Tail Length 3.50mm
 PCB Locator No
 PCB Retention None
 PCB Thickness - Recommended 1.60mm
 Packaging Type Bag
 Pitch - Mating Interface 2.50mm
 Plating min - Mating 4.064µm
 Plating min - Termination 4.064µm
 Polarized to Mating Part Yes
 Polarized to PCB No
 Shrouded Fully
 Stackable No
 Surface Mount Compatible (SMC) No
 Temperature Range - Operating -40° to +105°C
 Termination Interface: Style Through Hole

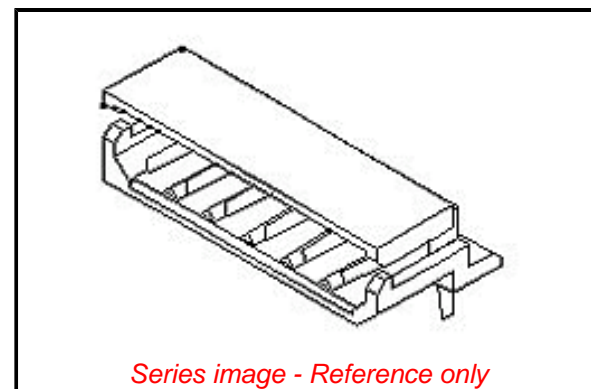

EU ELV

Not Relevant

EU RoHS

Compliant

REACH SVHC

Not Contained Per -
 ED/61/2018 (27 June
 2018)

Halogen-Free

Status

Not Low-Halogen

For more information, please visit [Contact US](#)

China ROHS

ELV

RoHS Phthalates

China RoHS

Green Image

Not Relevant

Not Contained

Search Parts in this Series

[5268 Series](#)

Mates With

[5264 Mini-SPOX Wire-to-Board Crimp Housing](#)

Electrical

Current - Maximum per Contact
Voltage - Maximum

3.0A
250V

Material Info

Engineering Number

5268-09A

Reference - Drawing Numbers

Packaging Specification
Product Specification
Sales Drawing

SPK-5268-001-001
PS-5264-001-001
SD-5268-NA

This document was generated on 11/26/2018

PLEASE CHECK WWW.MOLEX.COM FOR LATEST PART INFORMATION