

Distributed by:

JAMECO[®]
ELECTRONICS

www.Jameco.com ♦ 1-800-831-4242

The content and copyrights of the attached
material are the property of its owner.

Jameco Part Number 1966528

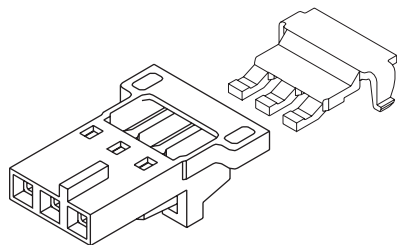
2.54mm (.100") Pitch**SL™
Crimp Housing****70066/73838****Single Row
Version N, TPA
with Positive Latch**

Circuits	70066 Version N TPA Crimp Housing	73838 TPA
	Order No.	Order No.
2	50-57-9702	73838-0002
3	50-57-9703	73838-0003
4	50-57-9704	73838-0004
5	50-57-9705	73838-0005
6	50-57-9706	73838-0006
7	50-57-9707	73838-0007
8	50-57-9708	73838-0008

Features and Benefits

- Optimizes terminal-to-housing retention
- Virtually eliminates terminal backout when TPA is locked into place
- Upon seating TPA, audible click denotes system activation
- White/black color contrast provides easy identification of TPA system
- Positive locking latch secures housing to mating connector
- Anti-entanglement/overstress ribs prevent discrete wires from catching under latch during harness manufacturing and storage

Reference Information

Product Specification: PS-73838, PS-70400

Packaging: Bag

UL File No.: E29179

CSA File No.: LR19980

Mates with: 70018, 70107A/B, 70541, 70543, 70545, 70551, 70553, 70555, 70634 and 74099

Use with: 73838 TPA and 70058 or 71851 crimp terminals

Designed In: Inches

Physical

Housing: Black polyester, UL 94V-0

TPA: White polyester, UL 94V-0

Operating Temperature: -40 to +105°C

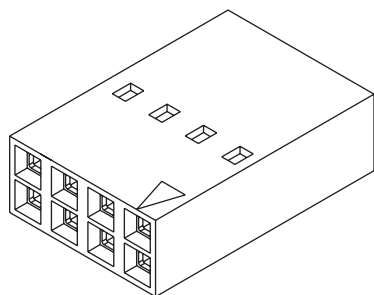
2.54mm (.100") Pitch**SL™
Crimp Housing****70450****Dual Row
Version A, Nonpolarized****Features and Benefits**

- Sizes 4 to 54 circuits
- End-to-end and side-to-side stackable for dual row connections to a 2.54mm (.100") pitch grid pin field

Reference Information

Product Specification: PS-70400

Packaging: Bag

UL File No.: E29179

CSA File No.: LR19980

Mates With: 8724, 70229, 70280, 70287, 70567, 70568,

71308 and 71349 Molex dual row headers

Use With: 70058 and 71851 crimp terminals

Designed In: Inches

Physical

Housing: Black polyester, UL 94V-0

Operating Temperature: -40 to +105°C

Delivered on a carrier with 20 pieces per strip.

Actual Size  **Universal Polarizing Pin**
40713-1
Order No. 15-04-0292

Not For Use With C-Grid III™ Components

Circuits	Order No.
4	22-55-2041
6	22-55-2061
8	22-55-2081
10	22-55-2101
12	22-55-2121
14	22-55-2141
16	22-55-2161
18	22-55-2181
20	22-55-2201

Circuits	Order No.
22	22-55-2221
24	22-55-2241
26	22-55-2261
28	22-55-2281
30	22-55-2301
32	22-55-2321
34	22-55-2341
36	22-55-2361
38	22-55-2381

Circuits	Order No.
40	22-55-2401
42	22-55-2421
44	22-55-2441
46	22-55-2461
48	22-55-2481
50	22-55-2501
52	22-55-2521
54	22-55-2541

2.54mm (.100") Pitch SL™ Crimp Housing

70450
Dual Row
Version B, Polarized

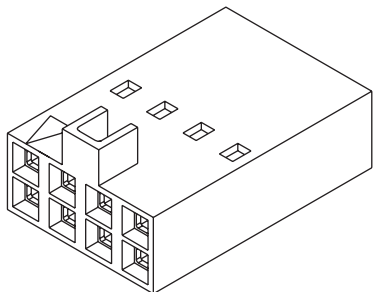

Not For Use With C-Grid III™ Components

Circuits	Order No.
4	22-55-2042
6	22-55-2062
8	22-55-2082
10	22-55-2102
12	22-55-2122
14	22-55-2142
16	22-55-2162
18	22-55-2182

Features and Benefits

- Sizes 4 to 50 circuits
- Polarized to mate with dual row, low profile shrouded headers

Reference Information

Product Specification: PS-70400
Packaging: Bag
UL File No.: E29179
CSA File No.: LR19980
Mates With: 70246, 70247, 87256 and 87257
Use With: 70058 and 71851 crimp terminals
Designed In: Inches

Physical

Housing: Black polyester, UL 94V-0
Operating Temperature: -40 to +105°C

Delivered on a carrier with 20 pieces per strip.

Actual Size  **Universal Polarizing Pin**
40713-1
Order No. 15-04-0292

2.54mm (.100") Pitch SL™ Crimp Housing

70450
Dual Row
Version C, Back Ribs

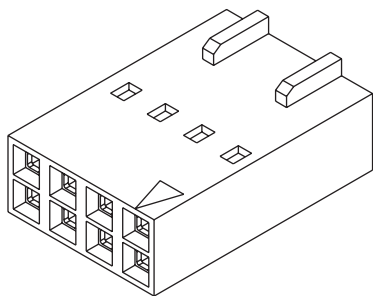

Not For Use With C-Grid III™ Components

Circuits	Order No.
4	22-55-2043
6	22-55-2063
8	22-55-2083
10	22-55-2103
12	22-55-2123
14	22-55-2143
16	22-55-2163
18	22-55-2183

Features and Benefits

- Sizes 4 to 50 circuits
- Designed to be used within 70013 dual row interim clip as a female connector assembly or 70022 dual row panel mount as a male pin assembly
- End-to-end stackable
- Back ribs maintain position of connector housings in interim clip and panel mount

Reference Information

Product Specification: PS-70400
Packaging: Bag
UL File No.: E29179
CSA File No.: LR19980
Accessories: 70013 and 70022
Use With: 70021, 70058 and 71851 crimp terminals
Designed In: Inches

Physical

Housing: Black polyester, UL 94V-0
Operating Temperature: -40 to +105°C

Delivered on a carrier with 20 pieces per strip.

Actual Size  **Universal Polarizing Pin**
40713-1
Order No. 15-04-0292

2.54mm (.100") Pitch SL™ Crimp Housing

70450
Dual Row
Version F

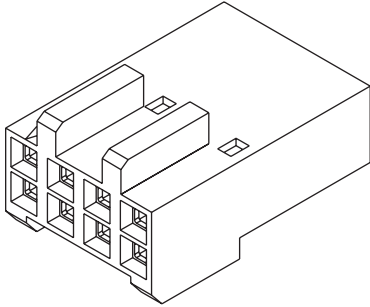

Features and Benefits

- Sizes 6 to 54 circuits
- Front guide ribs provide 180° polarization to mating connector

Reference Information

Product Specification: PS-70400
Packaging: Bag
UL File No.: E29179
CSA File No.: LR19980
Mates With: 8724, 70229, 70567, 70568 and 71349
Use With: 70058 and 71851 crimp terminals
Designed In: Inches

Physical

Housing: Black polyester, UL 94V-0
Operating Temperature: -40 to +105°C

Delivered on a carrier with 20 pieces per strip.

Actual Size  **Universal Polarizing Pin**
40713-1
Order No. 15-04-0292

Not For Use With C-Grid III™ Components

Circuits	Order No.
6	22-56-6067
8	22-56-6087
10	22-56-6107
12	22-56-6127
14	22-56-6147
16	22-56-6167
18	22-56-6187
20	22-56-6207
22	22-56-6227

Circuits	Order No.
24	22-56-6247
26	22-56-6267
28	22-56-6287
30	22-56-6307
32	22-56-6327
34	22-56-6347
36	22-56-6367
38	22-56-6387
40	22-56-6407

Circuits	Order No.
42	22-56-6427
44	22-56-6447
46	22-56-6467
48	22-56-6487
50	22-56-6507
52	22-56-6527
54	22-56-6547

2.54mm (.100") Pitch PCB and Wire Connectors



PRODUCT SPECIFICATION



LANGUAGE

ENGLISH

TABLE OF CONTENTS

<u>PARAGRAPH</u>	<u>DESCRIPTION</u>	<u>PAGE</u>
1.0	SCOPE	2
2.0	PRODUCT DESCRIPTION	2
3.0	APPLICABLE DOCUMENTS AND SPECIFICATIONS ..	4
4.0	RATINGS	4
5.0	PERFORMANCE	6
6.0	PACKAGING	9
7.0	QUALITY ASSURANCE PROVISIONS	9
8.0	QUALITY REQUIREMENTS	10
9.0	TEST SUMMARY	12

REV			TITLE				PRODUCT SPECIFICATION SINGLE ROW – STACKABLE LINEAR-(SL) CONNECTOR SYSTEM	
REVISE ON PC ONLY			THIS DOCUMENT CONTAINS INFORMATION THAT IS PROPRIETARY TO MOLEX INC. AND SHOULD NOT BE USED WITHOUT WRITTEN PERMISSION					
J	ADD CONNECTOR RETENTION CALLOUT UCP2005- MIBARRA 05/05/02							
REV	DESCRIPTION		WRITTEN BY:	CHECKED BY:	APPROVED BY:	DATE: YR / MO / DAY		
	DESIGN CONTROL	STATUS	FOX	STILES	BRINKMAN	99/11/16		
	UCP					FILE NAME	SHT NO.	
DOCUMENT NO. PS – 70400						PS-70400.LWP	1 OF 13	
BORDER TEMPLATE: ES-40000-3996 REV. A SHEET 3 95/MAR/10 EC U5-0926 DCBRD03.LWP								



PRODUCT SPECIFICATION



LANGUAGE

ENGLISH

1.0 SCOPE

This specification is intended to define the mechanical, electrical and environmental requirements for the SL .100" (2.54) pitch modular, single row wire-to-board and wire-to-wire system.

SL is designed for high density signal applications. The system includes: low profile latching vertical and right angle headers; low profile housings for male and female crimp terminals; pre-assembled, single piece pin and receptacle connectors for Insulation Displacement Technology (IDT); panel mounts for modular wire-to-wire remote interconnections; and SL offers design flexibility and automated harness-making capabilities when combined with our tooling.

2.0 PRODUCT DESCRIPTION:

2.1 The following Series are covered by this product specification:

- 70021, male, crimp terminal
- 70058, female box, crimp terminal
- 71851, female box, high force crimp terminal
- 70066 & 70107, single row, crimp housing
- 70450 & 74130, dual row, crimp housing
- 70400, female, single row, insulation displacement, connector assembly
- 70475 & 71178 ,male, single row, insulation displacement, connector assembly
- 70543, single row, .120" pocket, wire-to-board, shrouded header, vertical
- 70541, single row,.120" pocket, wire-to-board, shrouded header, vertical, split peg
- 70545, single row,.120" pocket, wire-to-board, shrouded header, vertical, tri-peg
- 70553, single row,.120" pocket, wire-to-board, shrouded header, right angle
- 70555, single row,.120" pocket, wire-to-board, shrouded header, right angle, tri-peg
- 70563, single row, .180" pocket, wire-to-board, shrouded header, vertical
- 70565, single row,.180" pocket, wire-to-board, shrouded header, vertical, tri-peg
- 70573, single row,.180" pocket, wire-to-board, shrouded header, right angle
- 70575, single row,.180" pocket, wire-to-board, shrouded header, right angle, tri-peg

REVISE ON PC ONLY		TITLE	PRODUCT SPECIFICATION SINGLE ROW – STACKABLE LINEAR (SL) CONNECTOR SYSTEM	
J	ADD CONNECTOR RETENTION CALLOUT UCP2005- MIBARRA 05/05/02			
REV	DESCRIPTION	THIS DOCUMENT CONTAINS INFORMATION THAT IS PROPRIETARY TO MOLEX INC. AND SHOULD NOT BE USED WITHOUT WRITTEN PERMISSION		
DOCUMENT NO. PS - 70400		FILE NAME	SHEET 2	
BORDER TEMPLATE: ES-40000-3996 REV. A SHEET 3 95/MAR/10 EC U5-0926 DCBRD03.LWP				



PRODUCT SPECIFICATION



LANGUAGE

ENGLISH

2.2 DIMENSIONS, MATERIALS AND SPECIFICATIONS:

2.2.1 Mating Pin Height

2.2.1.1 Maximum mating pin height: .320" (8.13 mm)

2.2.1.2 Minimum mating pin height: .200" (5.08 mm)

2.2.2 Centerline spacing (pitch): .100" (2.54 mm)

2.2.3 Wire Sizes: #22 - #28 AWG stranded wire, with an insulation diameter of .053" (1.35 mm) max.

2.2.4 Molex cable: 7307, 7767, 8996, 8997, 24226, 24241, 24369 and 24389.

2.2.5 Termination Method:

2.2.5.1 Crimp (70021, 70058)

2.2.5.2 IDT (70400, 70475)

2.2.6 Housings: (70066, 70450, 70107, 74130): Black Glass Filled Polyester, UL 94V-0

2.2.7 Terminals: (70021, 70058): Phosphor Bronze

2.2.7 Plating: Gold and Tin

2.2.7.1 Gold: 30 μ-in. min. Gold in select area over Nickel overall with 75 μ-in. Tin in select area over Nickel overall

or

Gold: 15 μ-in. min. Gold in select area over Nickel overall with 75 μ-in. Tin in select area over Nickel overall

2.2.7.2 Tin: 150 μ-in. min. Tin over Nickel overall.

See the appropriate Sales Drawing(s) for additional information on dimensions, materials, platings, and markings.

REVISE ON PC ONLY		TITLE	PRODUCT SPECIFICATION SINGLE ROW – STACKABLE LINEAR (SL) CONNECTOR SYSTEM	
J	ADD CONNECTOR RETENTION CALLOUT UCP2005- MIBARRA 05/05/02			
REV	DESCRIPTION	THIS DOCUMENT CONTAINS INFORMATION THAT IS PROPRIETARY TO MOLEX INC. AND SHOULD NOT BE USED WITHOUT WRITTEN PERMISSION		
DOCUMENT NO. PS - 70400		FILE NAME	SHEET 3	
BORDER TEMPLATE: ES-40000-3996 REV. A SHEET 3 95/MAR/10 EC U5-0926 DCBRD03.LWP				



PRODUCT SPECIFICATION



LANGUAGE

ENGLISH

2.3 SAFETY AGENCY APPROVALS:

UL File Number E29179
CSA File Number LR19980

3.0 APPLICABLE DOCUMENTS AND SPECIFICATIONS:

All documents referenced shall be of the latest revision. The order of precedence shall be as follows.

- Product Drawings
- This product specification
- Reference documents

3.1 REFERENCE DOCUMENTS:

- EIA 364 Electronic Industries Association, Recommended Standard
- MIL-STD-202: Test methods for electronics and electrical component parts.
- UL-94: Tests for flammability of plastic material

4.0 RATINGS:

4.1 VOLTAGE:

250 V

4.2 CURRENT:

- 1.2 A - 28 AWG
- 1.8 A - 26 AWG
- 3.0 A - 24 AWG
- 3.0 A - 22 AWG

4.2 TEMPERATURE:

Operating: -40 °C to +105 °C
Processing: See chart on next page.

REVISE ON PC ONLY		TITLE	PRODUCT SPECIFICATION SINGLE ROW – STACKABLE LINEAR (SL) CONNECTOR SYSTEM	
J	ADD CONNECTOR RETENTION CALLOUT UCP2005- MIBARRA 05/05/02			
REV	DESCRIPTION	THIS DOCUMENT CONTAINS INFORMATION THAT IS PROPRIETARY TO MOLEX INC. AND SHOULD NOT BE USED WITHOUT WRITTEN PERMISSION		
DOCUMENT NO. PS - 70400		FILE NAME	SHEET 4	
BORDER TEMPLATE: ES-40000-3996 REV. A SHEET 3 95/MAR/10 EC U5-0926 DCBRD03.LWP				



PRODUCT SPECIFICATION



LANGUAGE

ENGLISH

5.0 PERFORMANCE:

5.1 ELECTRICAL PERFORMANCE:

Item	Test Condition	Requirement
Contact Resistance (Low Level)	Mate Connectors with a maximum voltage of 20mV and a current of 100 mA.	30 milliohm Maximum Initial
Insulation Resistance	Mate Connectors with a voltage of 500 VDC between adjacent terminals and between terminals and ground.	1000 Megohms Minimum
Dielectric Withstanding Voltage	Mate Connectors with a voltage of 1500 VAC for 1 min. between adjacent terminals and between terminals and ground.	No breakdown
Capacitance	Measure between adjacent terminals at 1 MHz. (Loaded: 50 ohms impedance)	Loaded: 2 picofarad max. Unloaded: 0.5 picofarad max.

5.2 MECHANICAL PERFORMANCE:

Item	Test Condition	Requirement
Terminal Insertion and Withdrawal Forces	Insert and withdraw a terminal (male to female) at a rate of 25 ± 6mm (1 ± 1/4 inch) per minute.	70058 - Insertion force shall be 4.45 N (1.0 lb) max. and withdrawal 0.56 N (0.125 lb) min. 71851 - Insertion force shall be 13.34 N (3.0 lb) max. and withdrawal 1.67 N (0.375 lb) min
Terminal Retention Force (in Housing)	Axial pullout force on the terminal in the housing at a rate of 25 ± 6mm (1 ± 1/4 inch) per minute.	Contact : 17.79 N (4.0 lbs.) min.
Durability	Mate connectors up to 25 cycles for tin plating and 50 cycles for gold plating at a maximum rate of 10 cycles per minute prior to defined Environmental Tests.	Contact Resistance : 10 milliohms Maximum Change from Initial

REVISE ON PC ONLY		TITLE	PRODUCT SPECIFICATION SINGLE ROW – STACKABLE LINEAR (SL) CONNECTOR SYSTEM	
J	ADD CONNECTOR RETENTION CALLOUT UCP2005-MIBARRA 05/05/02			
REV	DESCRIPTION	THIS DOCUMENT CONTAINS INFORMATION THAT IS PROPRIETARY TO MOLEX INC. AND SHOULD NOT BE USED WITHOUT WRITTEN PERMISSION		
DOCUMENT NO. PS - 70400		FILE NAME	SHEET 5	
BORDER TEMPLATE: ES-40000-3996 REV. A SHEET 3 95/MAR/10 EC U5-0926 DCBRD03.LWP				



PRODUCT SPECIFICATION



LANGUAGE

ENGLISH

Item	Test Condition	Requirement
Vibration Mil-Std-1344 Method 2005.1 Condition I	Amplitude: 1.50mm (.060 inch) peak to peak Sweep: 10-55-10 Hz in one minute Duration: 2 hours in each X-Y-Z axis. (Test module shall be per Section 7.0)	Contact Resistance: 10 milliohms Maximum Change from Initial Discontinuity: not greater than one microsecond
Mechanical Shock Mil-Std-1344 Method 2004.1 Condition A	50 g's with three 1/2 sine wave form shocks in each X-Y-Z axis. (Test module shall be per Section 8.2)	Contact Resistance: 10 milliohms Maximum Change from Initial Discontinuity: not greater than one microsecond
Wire Pullout Force (Axial)	Apply an axial pullout force on the wire at a rate of 25 ± 6mm (1 ± 1/4 inch) per minute.	Pullout force - 75% tensile strength of wire, minimum.
Wire Pullout Force (Right Angle)	Apply a right angle pullout force on the wire at a rate of 25 ± 6mm (1 ± 1/4 inch) per minute.	Pullout force - 75% tensile strength of wire, minimum. 20 Newton's and below - no plastic deformation / no electrical discontinuity Above 20 and below 60 Newton's - slight non-functional plastic deformation / no electrical discontinuity.
Terminal Insertion Force (into Housing)	Apply an axial insertion force on the terminal at a rate of 25 ± 6mm (1 ± 1/4 inch) per minute.	13.34 N (3.0 lbs) maximum insertion force.
Wire Flex	Flex cable 180° for 500 cycles.	Contact resistance: 10 milliohms Maximum Change from Initial. Appearance: No Damage
Normal Force	Apply a perpendicular force at a rate of 25 ± 6mm (1 ± 1/4 inch) per minute on the contacts in a manner simulating actual use.	0.49 N (50 grams) minimum end of life, for gold plating 0.98 N (100 grams) minimum end of life, for tin plating.
Connector Retention	Apply a perpendicular force of 45 N to the wire harness using a free hanging weight.	No deformation or Terminal separation

REVISE ON PC ONLY		TITLE	PRODUCT SPECIFICATION SINGLE ROW – STACKABLE LINEAR (SL) CONNECTOR SYSTEM	
J	ADD CONNECTOR RETENTION CALLOUT UCP2005- MIBARRA 05/05/02			
REV	DESCRIPTION	THIS DOCUMENT CONTAINS INFORMATION THAT IS PROPRIETARY TO MOLEX INC. AND SHOULD NOT BE USED WITHOUT WRITTEN PERMISSION		
DOCUMENT NO. PS - 70400		FILE NAME	SHEET 6	
BORDER TEMPLATE: ES-40000-3996 REV. A SHEET 3 95/MAR/10 EC U5-0926 DCBRD03.LWP				



PRODUCT SPECIFICATION



LANGUAGE

ENGLISH

5.3 ENVIRONMENTAL PERFORMANCE

Item	Test Condition	Requirement
Thermal Shock Mil-Std-202F Method 107 E	Mate connectors exposed to 10 cycles of:	Appearance: No Damage Contact Resistance: 10 milliohms maximum change from initial
	<u>Temperature °C</u> <u>Duration (Min)</u>	
	-40 +0/-3 30	
	+25 +/-10 5 Max	
	+105 +3/-0 30	
	+25 +/-10 5 Max	
	-40 +0/-3 30	
Thermal Aging Mil-Std-202F Method 108	Mate connectors; expose to 240 hours at 105 ± 3° C	Appearance: No Damage Contact Resistance: 10 milliohms maximum change from initial
Humidity (Steady State) Mil-Std-202F Method 103	Mate connectors; expose to a temperature of : 85 ± 2°C with a Relative Humidity of 92 ± 3% for 96 hours. Note: Remove surface moisture and air dry for 1 hour prior to measurements.	Appearance: No Damage Contact Resistance: 10 milliohms maximum change from initial. Dielectric Withstanding Voltage: No Breakdown Insulation Resistance: 1000 Megohms Minimum

REVISE ON PC ONLY		TITLE	PRODUCT SPECIFICATION SINGLE ROW – STACKABLE LINEAR (SL) CONNECTOR SYSTEM	
J	ADD CONNECTOR RETENTION CALLOUT UCP2005- MIBARRA 05/05/02			
REV	DESCRIPTION	THIS DOCUMENT CONTAINS INFORMATION THAT IS PROPRIETARY TO MOLEX INC. AND SHOULD NOT BE USED WITHOUT WRITTEN PERMISSION		
DOCUMENT NO. PS - 70400		FILE NAME	SHEET 7	
BORDER TEMPLATE: ES-40000-3996 REV. A SHEET 3 95/MAR/10 EC U5-0926 DCBRD03.LWP				



PRODUCT SPECIFICATION



LANGUAGE

ENGLISH

Item	Test Condition	Requirement
Humidity (Cyclic) Mil-Std-202 Method 105	Mate connectors; expose for 10 cycles at 90-98% relative humidity with a transition time of 2.5 hours between extremes: <u>Temperature °C</u> <u>Duration (Min)</u> +25 ± 10 5 maximum +65 +3/-0 15 maximum Note: Remove surface moisture and air dry for one hour prior to measurements.	Appearance: No Damage Contact Resistance: 10 milliohms maximum change from initial. Dielectric Withstanding Voltage: No Breakdown Insulation Resistance: 1000 Megohms Minimum
Temperature Rise and Current Cycling	Temperature Rise: Mate the connectors; and measure the temperature rise at the rated current after 96 hours. Current Cycling: Mate connectors; measure the temperature rise at the rated current after 500 hours (45 minutes ON and 15 minutes OFF per hour).	Temperature Rise: 30°C above ambient maximum Temperature Rise: 30°C above ambient maximum
Solderability Molex SMES-152	Steam age 1 hr. Solder time 5 ± 0.5 seconds. Solder temperature: 245 ± 5°C Non activated flux.	95% of the immersed area must show no voids, pin holes
Flowing Mixed Gas (FMG)	Battelle Class II, 10 ppm Cl ₂ , 10 ppm H ₂ S, 100 ppm NO ₂ , 70 ± 1% R.H., 25 deg. C. 50-60 CFM. 10 days mated and 7 days unmated exposure.	Contact Resistance: 10 milliohms Maximum change from Initial
Resistance to Solder Heats	Solder Time 3 ± 0.5 seconds Solder Temperature: 260 ± 5°C Immerse leads to a depth of 1.57mm (.062 in.) from connector body.	Appearance: No damage or discoloration of connector materials.

6.0 PACKAGING:

Parts are packaged in trays, tubes or bulk packed, refer to appropriate Sales Drawing for specific information.

REVISE ON PC ONLY		TITLE	PRODUCT SPECIFICATION SINGLE ROW – STACKABLE LINEAR (SL) CONNECTOR SYSTEM
J	ADD CONNECTOR RETENTION CALLOUT UCP2005- MIBARRA 05/05/02		
REV	DESCRIPTION	THIS DOCUMENT CONTAINS INFORMATION THAT IS PROPRIETARY TO MOLEX INC. AND SHOULD NOT BE USED WITHOUT WRITTEN PERMISSION	
DOCUMENT NO. PS - 70400		FILE NAME	SHEET 8
BORDER TEMPLATE: ES-40000-3996 REV. A SHEET 3 95/MAR/10 EC U5-0926 DCBRD03.LWP			



PRODUCT SPECIFICATION



LANGUAGE

ENGLISH

7.0 QUALITY ASSURANCE PROVISIONS:

7.1 MATERIAL INSPECTION:

Shall consist of certification supported by verifying data.

7.2 ACCEPTANCE INSPECTION:

Acceptance of ongoing production product shall be determined by inspection according to Molex approved quality plans and required PPM levels for critical characteristics.

7.3 CONFORMANCE TESTING:

Shall be performed on production quality manufactured products. Sample size shall be per 8.1.

7.4 Gages:

Terminal insertion/withdrawal testing should be performed with the gage pin detailed below.

8.0 QUALIFICATION REQUIREMENTS:

8.1 QUALIFICATION TESTING:

1. Samples for testing shall be representative of normal production lots.
2. Sample groups shall consist of a minimum (5) mated pairs of headers and receptacles. 30 minimum data points per group shall be measured. Measurements shall be taken from the middle and ends of the connectors as a minimum.

REVISE ON PC ONLY		TITLE	PRODUCT SPECIFICATION SINGLE ROW – STACKABLE LINEAR (SL) CONNECTOR SYSTEM	
J	ADD CONNECTOR RETENTION CALLOUT UCP2005- MIBARRA 05/05/02			
REV	DESCRIPTION	THIS DOCUMENT CONTAINS INFORMATION THAT IS PROPRIETARY TO MOLEX INC. AND SHOULD NOT BE USED WITHOUT WRITTEN PERMISSION		
DOCUMENT NO. PS - 70400		FILE NAME	SHEET 9	
BORDER TEMPLATE: ES-40000-3996 REV. A SHEET 3 95/MAR/10 EC U5-0926 DCBRD03.LWP				



PRODUCT SPECIFICATION



LANGUAGE

ENGLISH

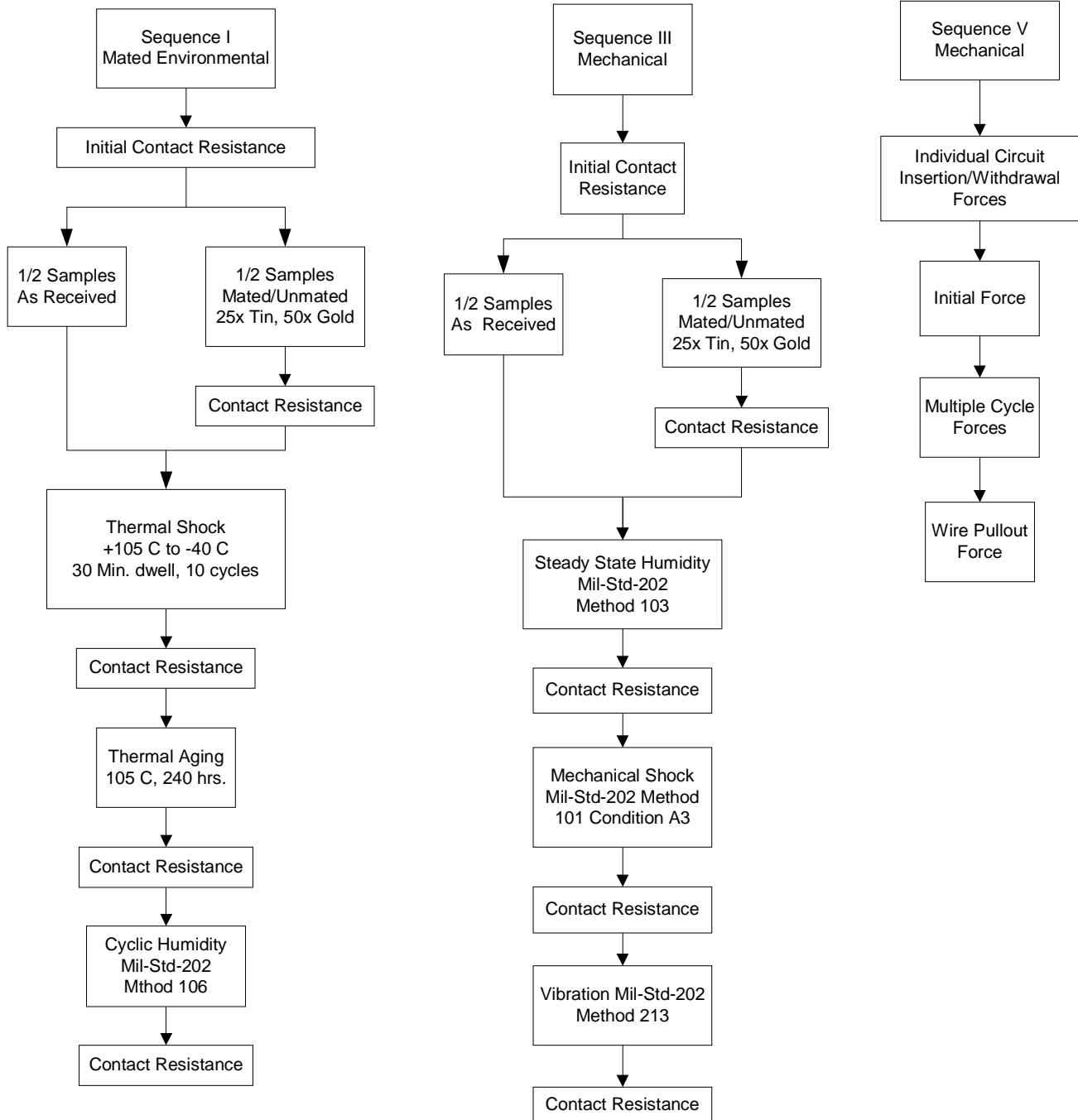

REVISE ON PC ONLY		TITLE	PRODUCT SPECIFICATION SINGLE ROW – STACKABLE LINEAR (SL) CONNECTOR SYSTEM	
J	ADD CONNECTOR RETENTION CALLOUT UCP2005-MIBARRA 05/05/02			
REV	DESCRIPTION	THIS DOCUMENT CONTAINS INFORMATION THAT IS PROPRIETARY TO MOLEX INC. AND SHOULD NOT BE USED WITHOUT WRITTEN PERMISSION		
DOCUMENT NO. PS - 70400		FILE NAME	SHEET 10	
BORDER TEMPLATE: ES-40000-3996 REV. A SHEET 3 95/MAR/10 EC U5-0926 DCBRD03.LWP				



PRODUCT SPECIFICATION



LANGUAGE

ENGLISH

9.0 TEST SUMMARY:

9.1 SEQUENCE I - MATED ENVIRONMENTAL:

TEST CONDITION	TREATMENT	REQUIREMENT	UNITS	MEAN	MINIMUM	MAXIMUM
Contact Resistance	Initial	30 max.	milliohms	14.47	13.77	15.08
	After Durability	10 max. Change from initial	Δ-milliohms	.09	-0.82	1.40
	After Shock (Thermal)	10 max. Change from initial	Δ-milliohms	.02	-1.15	1.32
	After Thermal Aging	10 max. Change from initial	Δ-milliohms	.00	-1.06	1.18
	After Humidity (Cyclic)	10 max. Change from initial	Δ-milliohms	.25	-1.00	1.78

9.2 SEQUENCE III - MECHANICAL:

TEST CONDITION	TREATMENT	REQUIREMENT	UNITS	MEAN	MINIMUM	MAXIMUM
Contact Resistance	Initial	30 max.	milliohms	8.6	8.0	9.4
	After Humidity (Steady State)	10 max. Change from initial	Δ-milliohms	8.6	8.0	9.6
	After Shock (Mechanical)	10 max. Change from initial	Δ-milliohms	8.7	8.1	9.9
	After Vibration	10 max. Change from initial	Δ-milliohms	8.7	8.1	9.4

REVISE ON PC ONLY		TITLE	PRODUCT SPECIFICATION SINGLE ROW – STACKABLE LINEAR (SL) CONNECTOR SYSTEM			
J	ADD CONNECTOR RETENTION CALLOUT UCP2005- MIBARRA 05/05/02				THIS DOCUMENT CONTAINS INFORMATION THAT IS PROPRIETARY TO MOLEX INC. AND SHOULD NOT BE USED WITHOUT WRITTEN PERMISSION	
	REV					
DOCUMENT NO. PS - 70400		FILE NAME	SHEET 11			
BORDER TEMPLATE: ES-40000-3996 REV. A SHEET 3 95/MAR/10 EC U5-0926 DCBRD03.LWP						



PRODUCT SPECIFICATION



LANGUAGE

ENGLISH

9.3 ENVIRONMENTAL PERFORMANCE:

TEST CONDITION	TREATMENT	REQUIREMENT	UNITS	MAXIMUM
Temperature Rise and Current Cycling (+30°C)	22 AWG	**** Minimum	Amps	3
	24 AWG	**** Minimum	Amps	3
	26 AWG	**** Minimum	Amps	1.8
	28 AWG	**** Minimum	Amps	1.2
	30 AWG	**** Minimum	Amps	0.70
	32 AWG	**** Minimum	Amps	0.45
	34 AWG	**** Minimum	Amps	0.32
	36 AWG	**** Minimum	Amps	0.21

9.4 SEQUENCE V - MECHANICAL:

70058 - MATING FORCE SEQUENCE 5.3						
TEST CONDITION	TREATMENT	PLATING	UNITS	MEAN	MINIMUM	MAXIMUM
Insertion Force	Initial	Tin	LB/(N)	0.73/(3.24)	0.62/(2.74)	0.82/(3.63)
		Gold	LB/(N)	0.39/(1.75)	0.28/(1.25)	0.59/(2.62)
	After 25 Cycles	Tin	LB/(N)	0.75/(3.32)	0.64/(2.83)	0.89/(3.94)
	After 50 Cycles	Gold	LB/(N)	0.44/(1.96)	0.27/(1.19)	0.55/(2.44)
Withdrawal Force	Initial	Tin	LB/(N)	0.97/4.31)	0.79/(3.52)	1.05/(4.65)
		Gold	LB/(N)	0.29/(1.28)	0.20/(0.89)	0.44/(1.97)
	After 25 Cycles	Tin	LB/(N)	0.77/(3.43)	0.68/(3.04)	0.90/(4.02)
	After 50 Cycles	Gold	LB/(N)	0.38/(1.69)	0.29/(1.29)	0.56/(2.50)

71851 - MATING FORCE SEQUENCE 5.3						
TEST CONDITION	TREATMENT	PLATING	UNITS	MEAN	MINIMUM	MAXIMUM
Insertion Force	Initial	Tin	LB/N	2.39/10.62	2.24/9.96	2.53/11.25
		Gold	LB/N	0.99/4.39	0.91/4.05	1.05/4.67
	After 25 Cycles	Tin	LB/N	2.18/9.71	1.60/7.12	2.82/12.54
	After 50 Cycles	Gold	LB/N	1.01/4.48	0.86/3.83	1.17/5.20
Withdrawal Force	Initial	Tin	LB/N	2.68/11.92	2.28/10.14	3.18/14.15
		Gold	LB/N	0.69/3.07	0.62/2.76	0.77/3.43
	After 25 Cycles	Tin	LB/N	2.70/12.02	1.79/7.96	4.23/18.82
	After 50 Cycles	Gold	LB/N	1.07/4.76	0.84/3.74	1.25/5.56

REVISE ON PC ONLY		TITLE	PRODUCT SPECIFICATION SINGLE ROW – STACKABLE LINEAR (SL) CONNECTOR SYSTEM			
J	ADD CONNECTOR RETENTION CALLOUT UCP2005-MIBARRA 05/05/02				THIS DOCUMENT CONTAINS INFORMATION THAT IS PROPRIETARY TO MOLEX INC. AND SHOULD NOT BE USED WITHOUT WRITTEN PERMISSION	
	REV					
DOCUMENT NO. PS - 70400		FILE NAME	SHEET 12			
BORDER TEMPLATE: ES-40000-3996 REV. A SHEET 3 95/MAR/10 EC U5-0926 DCBRD03.LWP						



PRODUCT SPECIFICATION



LANGUAGE

ENGLISH

TEST CONDITION	TREATMENT	PLATING	UNITS	MEAN	MINIMUM	MAXIMUM
Wire Pullout Force (Axial)	22 AWG with strain relief	**** Minimum	N/LB	65.3/14.67	56.2/12.63	72.4/16.28
	22 AWG w/o strain relief	**** Minimum	N/LB	48.0/10.78	39.2/8.81	54.5/12.24
	24 AWG	**** Minimum	N/LB	37.0/8.32	28.5/6.40	44.9/10.10
	26 AWG	**** Minimum	N/LB			
	28 AWG	**** Minimum	N/LB			
	30 AWG	**** Minimum	N/LB			
	32 AWG	**** Minimum	N/LB			
	34 AWG	**** Minimum	N/LB			
	36 AWG	**** Minimum	N/LB			

9.5 MISCELLANEOUS:

TEST CONDITION	TREATMENT	REQUIREMENT	UNITS	MEAN	MINIMUM	MAXIMUM
Terminal Retention Force (in Housing)	Initial	**** Minimum	N/LB	37.94/8.53	23.04/5.18	55.74/12.53
Insulation Resistance	Initial	1000 Min.	Megaohms	Passed		
	After Shock (Thermal)	1000 Min.	Megaohms	Passed		
	After Thermal Aging	1000 Min.	Megaohms	Passed		
	After Humidity (Steady State)	1000 Min.	Megaohms	Passed		
	After Humidity (Cyclic)	1000 Min.	Megaohms	Passed		

REVISE ON PC ONLY		TITLE	PRODUCT SPECIFICATION SINGLE ROW – STACKABLE LINEAR (SL) CONNECTOR SYSTEM			
J	ADD CONNECTOR RETENTION CALLOUT UCP2005-MIBARRA 05/05/02				THIS DOCUMENT CONTAINS INFORMATION THAT IS PROPRIETARY TO MOLEX INC. AND SHOULD NOT BE USED WITHOUT WRITTEN PERMISSION	
	REV					
DOCUMENT NO. PS - 70400		FILE NAME	SHEET 13			
BORDER TEMPLATE: ES-40000-3996 REV. A SHEET 3 95/MAR/10 EC U5-0926 DCBRD03.LWP						

NOTES:

1. MATERIAL: G.F. POLYESTER
2. HOUSING TO BE USED WITH TERMINAL NOS. 70028, 70058, AND 71851.
3. HOUSING TO BE USED WITH (0.64)/.025 SQUARE OR ROUND PINS.
4. REFER TO MOLEX PRODUCT SPECIFICATION PS-70058.
5. PACKAGE PER PK-70450-100.
6. PARTS CONFORM TO CLASS C OF COSMETIC SPECIFICATION PS-45499-002.

OPTION "B"

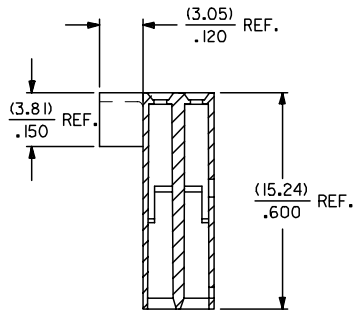
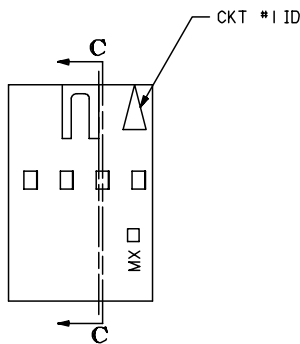
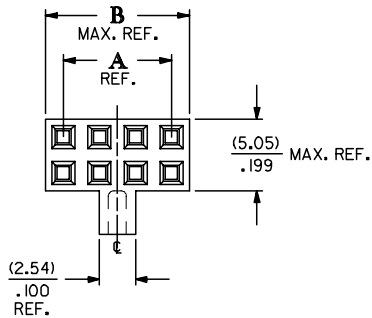

SECTION C-C

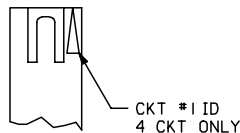

CKT. SIZE	EDP. NO.	ENG. NO.	DIM "A" REF.	DIM "B" MAX. REF.
4	022-55-2042	70450-0050	(2.54) .100	(5.05) .199
6	022-55-2062	70450-0051	(5.08) .200	(7.59) .299
8	022-55-2082	70450-0052	(7.62) .300	(10.13) .399
10	022-55-2102	70450-0053	(10.16) .400	(12.67) .499
12	022-55-2122	70450-0054	(12.70) .500	(15.21) .599
14	022-55-2142	70450-0055	(15.24) .600	(17.75) .699
16	022-55-2162	70450-0056	(17.78) .700	(20.29) .799
18	022-55-2182	70450-0057	(20.32) .800	(22.83) .899
20	022-55-2202	70450-0058	(22.86) .900	(25.37) .999
22	022-55-2222	70450-0059	(25.40) 1.000	(27.91) 1.099
24	022-55-2242	70450-0060	(27.94) 1.100	(30.45) 1.199
26	022-55-2262	70450-0061	(30.48) 1.200	(32.99) 1.299
28	022-55-2282	70450-0062	(33.02) 1.300	(35.53) 1.399
30	022-55-2302	70450-0063	(35.56) 1.400	(38.07) 1.499
32	022-55-2322	70450-0064	(38.10) 1.500	(40.61) 1.599
34	022-55-2342	70450-0065	(40.64) 1.600	(43.15) 1.699
36	022-55-2362	70450-0066	(43.18) 1.700	(45.69) 1.799
38	022-55-2382	70450-0067	(45.72) 1.800	(48.23) 1.899
40	022-55-2402	70450-0068	(48.26) 1.900	(50.77) 1.999
42	022-55-2422	70450-0069	(50.80) 2.000	(53.31) 2.099
44	022-55-2442	70450-0070	(53.34) 2.100	(55.85) 2.199
46	022-55-2462	70450-0071	(55.88) 2.200	(58.39) 2.299
48	022-55-2482	70450-0072	(58.42) 2.300	(60.93) 2.399
50	022-55-2502	70450-0073	(60.96) 2.400	(63.47) 2.499
52	NOT TOOLED	70450-0074	(63.50) 2.500	(66.01) 2.599
54	NOT TOOLED	70450-0075	(66.04) 2.600	(68.55) 2.699

ADD COSMETIC SPEC EC NO: UCP2007-2009 DRAWN: JORGAN 2007/02/23 CHKD: MS BARRA 2007/02/23 APPR: SMILLER 2007/02/27	QUALITY SYMBOLS ▽=0 ▽=0	GENERAL TOLERANCES (UNLESS SPECIFIED)		DIMENSION STYLE MM/IN		SCALE 4:1	DESIGN UNITS INCH	THIRD ANGLE PROJECTION	
		4 PLACES ± --- ± --- 3 PLACES ± --- ± .010 2 PLACES ± 0.25 ± .014 1 PLACE ± 0.35 ± --- ANGULAR ±1/2°	DRAWN BY MJM DATE 1986/10/22	TITLE HOUSING-CONNECTOR DUAL ROW (2.54)/.100 GRID WITH POLARIZATION KEY		MOLEX INCORPORATED		SHEET NO. 1 OF 1	
		DRAFT WHERE APPLICABLE MUST REMAIN WITHIN DIMENSIONS		SEE CHART		SD-70450-0050-0075		THIS DRAWING CONTAINS INFORMATION THAT IS PROPRIETARY TO MOLEX INCORPORATED AND SHOULD NOT BE USED WITHOUT WRITTEN PERMISSION	
		MATERIAL NO.		DOCUMENT NO.		SIZE C		SHEET NO. 1 OF 1	