

Distributed by:

**JAMECO**<sup>®</sup>  
ELECTRONICS

**www.Jameco.com ♦ 1-800-831-4242**

The content and copyrights of the attached  
material are the property of its owner.

Jameco Part Number 797030

## FEATURES AND SPECIFICATIONS

### Features and Benefits

- Sizes 2 to 18 circuits
- Provides left to right polarization when mated with 41695 or 43061 .156" crimp housing with the optional polarizing ribs
- Various pin lengths available (contact Molex)
- Optional voided circuits available
- End-to-end stackable

### Reference Information

Product Specification: PS-08-50

Packaging: Bag

UL File No.: E29179

CSA File No.: LR19980

TUV File No.: R75108

Mates With: [2139](#), [2145](#), [3069](#), [6442](#), [7674](#), [7675](#), [41695](#) and [41815](#)

Designed In: Inches

### Electrical

Voltage: 250V

Current: 7.0A

Contact Resistance: 6mΩ max.

Dielectric Withstanding Voltage: 1500V

Insulation Resistance: 50K MΩ min.

### Mechanical

Durability:

Tin—25 cycles max.

Gold—100 cycles max.

### Physical

Housing: Polyester, UL 94V-0

Contact: Brass, 1.14mm (.045") pins

Plating: See Table

Operating Temperature: 0 to +75°C

**molex®** **3.96mm (.156") Pitch**  
**KK®**

**Solid Header**

**41792**

**Right Angle, Friction Lock**

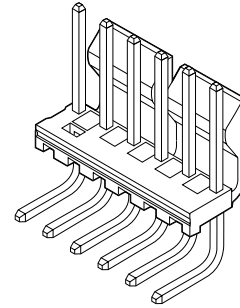

## CATALOG DRAWING (FOR REFERENCE ONLY)

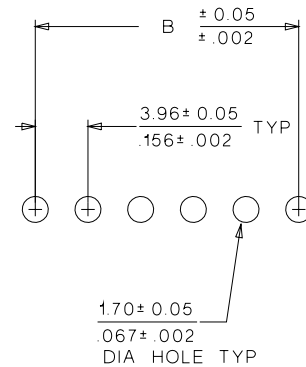
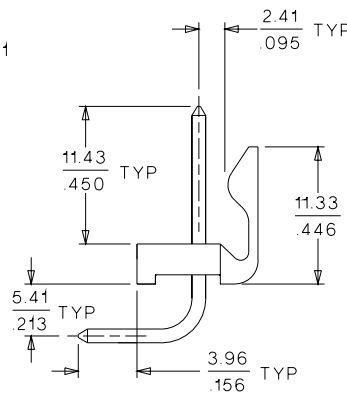
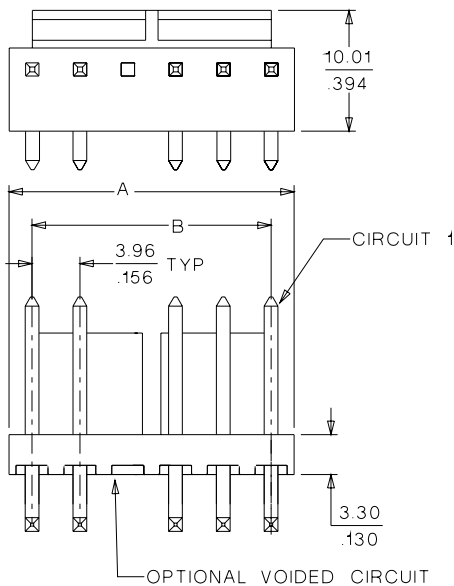

PCB LAYOUT: COMPONENT SIDE  
RECOMMENDED PCB THICKNESS

## ORDERING INFORMATION AND DIMENSIONS

Circuits	Order No.				Dimension	
	Tin	15μ" Select Gold	30μ" Select Gold	Overall Gold	A	B
2	26-60-5020	41792-0511	41792-0528	26-61-5020	7.77 (.306)	3.96 (.156)
3	26-60-5030	41792-0512	41792-0529	26-61-5030	11.73 (.462)	7.92 (.312)
4	26-60-5040	41792-0513	41792-0530	26-61-5040	15.70 (.618)	11.89 (.468)
5	26-60-5050	41792-0514	41792-0531	26-61-5050	19.66 (.774)	15.85 (.624)
6	26-60-5060	41792-0515	41792-0532	26-61-5060	23.62 (.930)	19.81 (.780)
7	26-60-5070	41792-0516	41792-0533	26-61-5070	27.58 (1.086)	23.77 (.936)
8	26-60-5080	41792-0517	41792-0534	26-61-5080	31.55 (1.242)	27.74 (1.092)
9	26-60-5090	41792-0518	41792-0535	26-61-5090	35.51 (1.398)	31.70 (1.248)
10	26-60-5100	41792-0519	41792-0536	26-61-5100	39.47 (1.554)	35.66 (1.404)
11	26-60-5110	41792-0520	41792-0537	26-61-5110	43.43 (1.710)	39.62 (1.560)
12	26-60-5120	41792-0521	41792-0538	26-61-5120	47.40 (1.866)	43.59 (1.716)
13	26-60-5130	41792-0522	41792-0539	26-61-5130	51.36 (2.022)	47.55 (1.872)
14	26-60-5140	41792-0523	41792-0540	26-61-5140	55.32 (2.178)	51.51 (2.028)
15	26-60-5150	41792-0524	41792-0541	26-61-5150	59.28 (2.334)	55.47 (2.184)
16	26-60-5160	41792-0525	41792-0542	26-61-5160	63.25 (2.490)	59.44 (2.340)
17	26-60-5170	41792-0526	41792-0543	26-61-5170	67.21 (2.646)	63.40 (2.496)
18	26-60-5180	41792-0527	41792-0544	26-61-5180	71.17 (2.802)	67.36 (2.652)

Circuit number designation is for ordering purposes only, check corresponding circuit designation on mating connector



# PRODUCT SPECIFICATION

## 1.0 SCOPE

This Product Specification covers the 3.96 mm (.156 inch) centerline (pitch) 1.14mm (.045) square pin headers when mated with either printed circuit board (PCB) connectors or connectors terminated with 18 to 26 AWG wire using crimp technology.

## 2.0 PRODUCT DESCRIPTION

### 2.1 PRODUCT NAME AND SERIES NUMBERS

Crimp Terminals: 2478,2578,2878,2477,  
Crimp Housings: 2139, 41695  
PCB Connectors: 2145, 41815  
Headers: 41771, 41772, 41791, 41792, 42471, 42472, 42491, 42492, 41661, 41662, 41671, 61672, 41681, 41682  
Other products conforming to this specification are noted on the individual drawings.

### 2.2 DIMENSIONS, MATERIALS, PLATINGS AND MARKINGS

Terminal Material: Brass or Phos. Bronze (for Max performance use phos bronze material.)  
Housing: Nylon or Polyester  
Pins: Brass or Phos. Bronze  
For more information on dimensions, materials, and plating see the individual drawings.

### 2.3 SAFETY AGENCY APPROVALS

UL File Number ..... E29179  
CSA .....LR19980

## 3.0 APPLICABLE DOCUMENTS AND SPECIFICATIONS

None

## 4.0 RATINGS

### 4.1 VOLTAGE

250 Volts

**4.2 CURRENT** (Current is dependent on connector size, contact material, plating, ambient temperature, printed circuit board characteristics and related factors. Actual current rating is application dependent and should be evaluated for each application.)

#### a. For Crimp Terminals- and Applicable Wires

Wire Awg	Amps (Max) With Brass	Amps (Max) With Phos Bronze	Wire Insulation Dia
18	5.00	7.00	See terminal drawings
20	4.75	6.25	See terminal drawings
22	4.50	5.50	See terminal drawings
24	4.25	5.00	See terminal drawings
26	4.00	4.50	See terminal drawings

<b>REVISION:</b> <b>R</b>	<b>ECR/ECN INFORMATION:</b> <b>EC No: UCR2002-0299</b> <b>DATE: 2001 / 09 / 18</b>	<b>TITLE:</b> <b>PRODUCT SPECIFICATION</b> <b>.156 CENTER KK CONNECTORS</b>	<b>SHEET No.</b> <b>1 of 5</b>
<b>DOCUMENT NUMBER:</b> <b>PS-08-50</b>	<b>CREATED / REVISED BY:</b> <b>SAMIEC</b>	<b>CHECKED BY:</b> <b>MUELLER</b>	<b>APPROVED BY:</b> <b>MARGULIS</b>



# PRODUCT SPECIFICATION

## 4.2 CURRENT (cont)

### b. For Printed Circuit Board Connectors

Connector Style	Amps (Max) With Brass	Amps (Max) With Phos Bronze
Top Entry	4.50	5.00
Right Angle	4.50	5.00
Bottom Entry	4.00	4.50

## 4.3 TEMPERATURE (ambient + 30°C temp rise)

	Brass	Phos Bronze
Operating Temperature	0°C to +50°C	0°C to +75°C
Non Operating Temperature	-40°C to +105°C	-40°C to +105°C

## 5.0 PERFORMANCE

### 5.1 ELECTRICAL REQUIREMENTS

DESCRIPTION	TEST CONDITION	REQUIREMENT
Contact Resistance (Low Level)	Mate connectors: apply a maximum voltage of 20 mV and a current of 100 mA.	10 milliohms MAXIMUM [initial]
Contact Resistance of Wire Termination (Low Level)	Terminate the applicable wire to the terminal and measure wire using a voltage of 20 mV and a current of 100 mA.	2 milliohms MAXIMUM [initial]
Insulation Resistance	Unmate & unmount connectors: apply a voltage of 500 VDC between adjacent terminals and between terminals to ground.	1000 Megohms MINIMUM
Dielectric Withstanding Voltage	Unmate connectors: apply a voltage of {two times the rated voltage plus 1000 volts} VAC for 1 minute between adjacent terminals and between terminals to ground.	No breakdown
Capacitance	Measure between adjacent terminals at 1 MHz.	1.2 picofarads MAXIMUM
Temperature Rise (via Current Cycling)	Mate connectors: measure the temperature rise at the rated current after: 1) 96 hours (steady state) 2) 240 hours (45 minutes ON and 15 minutes OFF per hour) 3) 96 hours (steady state)	Temperature rise: +30°C MAXIMUM

REVISION: <b>R</b>	ECR/ECN INFORMATION: EC No: <b>UCR2002-0299</b> DATE: <b>2001 / 09 / 18</b>	TITLE: <b>PRODUCT SPECIFICATION .156 CENTER KK CONNECTORS</b>	SHEET No. <b>2 of 5</b>
DOCUMENT NUMBER: <b>PS-08-50</b>	CREATED / REVISED BY: <b>SAMIEC</b>	CHECKED BY: <b>MUELLER</b>	APPROVED BY: <b>MARGULIS</b>



# PRODUCT SPECIFICATION

## 5.2 MECHANICAL REQUIREMENTS

DESCRIPTION	TEST CONDITION	REQUIREMENT
Connector Mate and Unmate Forces	Per circuit when mated to an .045 Sq. pin. Mate and unmate connector (male to female) at a rate of $25 \pm 6$ mm ( $1 \pm \frac{1}{4}$ inch) per minute.	10.0 N (2.25 lbf) MAXIMUM insertion force & 3.7 N (0.84 lbf) MINIMUM withdrawal force
Terminal Insertion Force (into Housing)	Apply an axial insertion force on the terminal at a rate of $25 \pm 6$ mm ( $1 \pm \frac{1}{4}$ inch). (Forces will change with platings and materials.)	17.8 N (4.0 lbf) MAXIMUM insertion force
Terminal Retention Force (in Housing)	Axial pullout force on the terminal in the housing at a rate of $25 \pm 6$ mm ( $1 \pm \frac{1}{4}$ inch) per minute. (Forces will change with platings and materials.)	35.6 N (8.0 lbf) MINIMUM withdrawal force
Durability	Mate connectors up to 25 cycles at a maximum rate of 10 cycles per minute prior to Environmental Tests.	10 milliohms MAXIMUM (change from initial)
Vibration (Random)	Mate connectors and vibrate per EIA 364-28, test condition VII.	10 milliohms MAXIMUM (change from initial) & Discontinuity < 1 microsecond
Shock (Mechanical)	Mate connectors and shock at 50 g's with $\frac{1}{2}$ sine wave (11 milliseconds) shocks in the $\pm X, \pm Y, \pm Z$ axes (18 shocks total).	10 milliohms MAXIMUM (change from initial) & Discontinuity < 1 microsecond
Wire Pullout Force (Axial)	Apply an axial pullout force on the wire at a rate of $25 \pm 6$ mm ( $1 \pm \frac{1}{4}$ inch). (For maximum performance use Molex application tooling with stranded tinned copper wire)	18 awg = 89 N (20 lbf) 20 awg = 66 N (15 lbf) 22 awg = 53 N (12 lbf) 24 awg = 35 N (8 lbf) 26 awg = 22 N (5 lbf)
Normal Force	Apply a perpendicular force.	7.34 N (748 grams) average

REVISION: <b>R</b>	ECR/ECN INFORMATION: EC No: <b>UCR2002-0299</b> DATE: <b>2001 / 09 / 18</b>	TITLE: <b>PRODUCT SPECIFICATION .156 CENTER KK CONNECTORS</b>	SHEET No. <b>3 of 5</b>
DOCUMENT NUMBER: <b>PS-08-50</b>	CREATED / REVISED BY: <b>SAMIEC</b>	CHECKED BY: <b>MUELLER</b>	APPROVED BY: <b>MARGULIS</b>



# PRODUCT SPECIFICATION

## 5.3 ENVIRONMENTAL REQUIREMENTS

DESCRIPTION	TEST CONDITION	REQUIREMENT										
Shock (Thermal)	Mate connectors; expose to 5 cycles of: <table border="1"> <thead> <tr> <th>Temperature °C</th> <th>Duration (Minutes)</th> </tr> </thead> <tbody> <tr> <td>-40 +0/-3</td> <td>30</td> </tr> <tr> <td>+25 ±10</td> <td>5 MAXIMUM</td> </tr> <tr> <td>+105 +3/-0</td> <td>30</td> </tr> <tr> <td>+25 ±10</td> <td>5 MAXIMUM</td> </tr> </tbody> </table>	Temperature °C	Duration (Minutes)	-40 +0/-3	30	+25 ±10	5 MAXIMUM	+105 +3/-0	30	+25 ±10	5 MAXIMUM	10 milliohms MAXIMUM (change from initial) & Visual: No Damage
Temperature °C	Duration (Minutes)											
-40 +0/-3	30											
+25 ±10	5 MAXIMUM											
+105 +3/-0	30											
+25 ±10	5 MAXIMUM											
Thermal Aging	Mate connectors; expose to: 96 hours at 105 ± 2°C	10 milliohms MAXIMUM (change from initial]) & Visual: No Damage										
Humidity (Steady State)	Mate connectors: expose to a temperature of 40 ± 2°C with a relative humidity of 90-95% for 96 hours.  Note: Remove surface moisture and air dry for 1 hour prior to measurements.	10 milliohms MAXIMUM (change from initial) & Dielectric Withstanding Voltage: No Breakdown at 500 VAC & Insulation Resistance: 1000 Megohms MINIMUM & Visual: No Damage										
Humidity (Cyclic)	Mate connectors: cycle per EIA-364-31: 24 cycles at temperature 25 ± 3°C at 80 ± 5% relative humidity and 65 ± 3°C at 50 ± 5% relative humidity; dwell time of 1.0 hour; ramp time of 0.5 hours.  {Note: Remove surface moisture and air dry for 1 hour prior to measurements.}	10 milliohms MAXIMUM (change from initial) & Dielectric Withstanding Voltage: No Breakdown at 500 VAC & Insulation Resistance: 1000 Megohms MINIMUM & Visual: No Damage										
Solderability	Per SMES-152	Solder coverage: 95% MINIMUM (per SMES-152)										

REVISION: <b>R</b>	ECR/ECN INFORMATION: EC No: <b>UCR2002-0299</b> DATE: <b>2001 / 09 / 18</b>	TITLE: <b>PRODUCT SPECIFICATION .156 CENTER KK CONNECTORS</b>	SHEET No. <b>4 of 5</b>
DOCUMENT NUMBER: <b>PS-08-50</b>	CREATED / REVISED BY: <b>SAMIEC</b>	CHECKED BY: <b>MUELLER</b>	APPROVED BY: <b>MARGULIS</b>



# PRODUCT SPECIFICATION

## 5.3 ENVIRONMENTAL REQUIREMENTS

DESCRIPTION	TEST CONDITION	REQUIREMENT
Solder Resistance	Dip connector terminal tails in solder: Solder Duration: $5 \pm 0.5$ seconds; Solder Temperature: $230 \pm 5^\circ\text{C}$	Visual: No Damage to insulator material
Salt Spray	Mate connectors: Duration: 48 hours exposure; Atmosphere: salt spray from a 5% solution; Temperature: $35 +1/-2^\circ\text{C}$	10 milliohms MAXIMUM (change from initial) & Visual: No Damage
Cold Resistance	Mate connectors: Duration: 96 hours; Temperature: $-40 \pm 3^\circ\text{C}$	10 milliohms MAXIMUM (change from initial) & Visual: No Damage
Corrosive Atmosphere: Flowing Mixed Gas (FMG)	Mate connectors: Test per EIA-364-65, method 2A	10 milliohms MAXIMUM (change from initial) & Visual: No Damage

## 6.0 PACKAGING

Parts shall be packaged to protect against damage during handling, transit and storage.

## 7.0 GAGES AND FIXTURES

## 8.0 OTHER

REVISION: <b>R</b>	ECR/ECN INFORMATION: EC No: <b>UCR2002-0299</b> DATE: <b>2001 / 09 / 18</b>	TITLE: <b>PRODUCT SPECIFICATION .156 CENTER KK CONNECTORS</b>	SHEET No. <b>5 of 5</b>
DOCUMENT NUMBER: <b>PS-08-50</b>	CREATED / REVISED BY: <b>SAMIEC</b>	CHECKED BY: <b>MUELLER</b>	APPROVED BY: <b>MARGULIS</b>

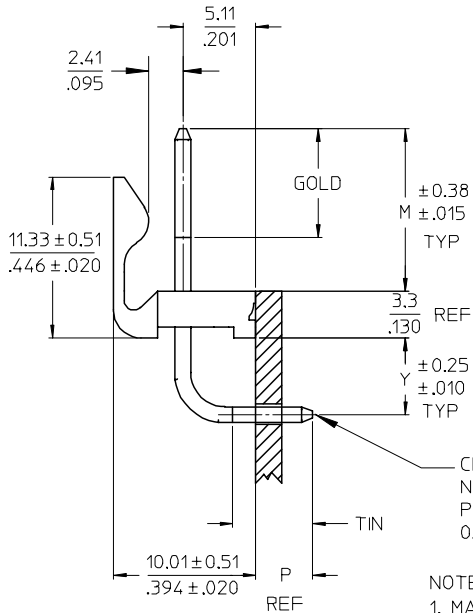

CENTERLINE OF PIN AT TIP  
NOT TO VARY FROM CENTERLINE OF  
PIN AT DATUM -D- BY MORE THAN  
0.20 / .008 IN ANY DIRECTION.

CENTERLINE OF PIN AT TIP  
NOT TO VARY FROM CENTERLINE OF  
PIN AT DATUM -D- BY MORE THAN  
0.20 / .008 IN ANY DIRECTION.

NOTES:

- MATERIAL: HEADER-GLASS FILLED POLYESTER, 94V-0, MOLDED NATURAL (WHITE).
- FINISH: (102) OVERALL TIN: .00508/.000200 MIN OVER .00254/.000100 MIN COPPER.  
(154) OVERALL TIN: .00254/.000100 MIN OVER .00127/.000050 MIN NICKEL.  
\*(208) SELECT GOLD: .00038/.000015 MIN, SELECT TIN: .00254/.000100 MIN,  
OVERALL NICKEL UNDERPLATE: .00127/.000050 MIN.  
\*(228) SELECT GOLD: .00076/.000030 MIN, SELECT TIN: .00254/.000100 MIN,  
OVERALL NICKEL UNDERPLATE: .00127/.000050 MIN.  
FOR ADDITIONAL PLATING INFO, SEE SDES-88.  
\*THE PRIMARY SHIPPING CARTON WILL BE LABELED "COMPLIANT TO RoHS DIRECTIVE 2002/95/EC  
AND ELV ANNEX II OF DIRECTIVE 2000/53/EC". CARTONS WITHOUT THIS LABEL MAY CONTAIN  
PRODUCT WITH TIN-LEAD PLATING.
- PRODUCT SPECIFICATION AND PROCESS PARAMETERS: SEE PS-08-50.
- PACKAGING INFORMATION: SEE CHART
- SOLDERABILITY: PER SMES-152.
- PIN PUSH-OUT FORCE: PRIOR TO SOLDERING, A 3 LB. MINIMUM FORCE (IN EITHER DIRECTION)
- PARTS ARE STACKABLE END TO END ON 3.96/.156 CENTERS.

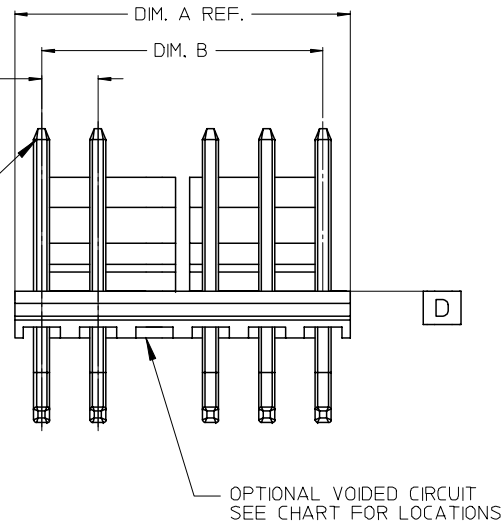

CKT	DIM. A	DIM. B
2	7.77 .306	3.96±0.05 .156±.002
3	11.73 .462	7.92±0.08 .312±.003
4	15.70 .618	11.89±0.08 .468±.003
5	19.66 .774	15.85±0.10 .624±.004
6	23.62 .930	19.81±0.10 .780±.004
7	27.58 1.086	23.77±0.10 .936±.004
8	31.55 1.242	27.74±0.13 1.092±.005
9	35.51 1.398	31.70±0.13 1.248±.005
10	39.47 1.554	35.66±0.13 1.404±.005
11	43.43 1.710	39.62±0.15 1.560±.006
12	47.40 1.866	43.59±0.15 1.716±.006
13	51.36 2.022	47.55±0.15 1.872±.006
14	55.32 2.178	51.51±0.18 2.028±.007
15	59.28 2.334	55.47±0.18 2.184±.007
16	63.25 2.490	59.44±0.18 2.340±.007
17	67.21 2.646	63.40±0.20 2.496±.008
18	71.17 2.802	67.36±0.20 2.652±.008

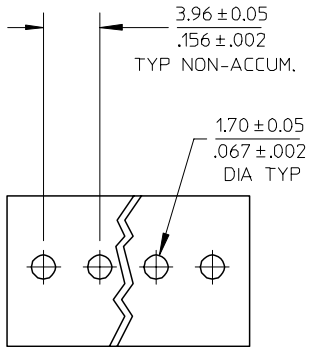

PCB LAYOUT: COMPONENT SIDE

2-*	H3	UPDATE PER ECN	REV
1	REV	EC NO: UCP2006-1776	
SHT		DRWN:DPETERSON 2006/04/04	
		CHKD:ADERR 2006/04/05	
		APPR:FSMITH 2006/04/11	

QUALITY SYMBOLS	DESCRIPTION
▽=0	
▽=0	

GENERAL TOLERANCES (UNLESS SPECIFIED)	
4 PLACES	± ---
3 PLACES	± ---
2 PLACES	± 0.25
1 PLACE	± 0.38
ANGULAR ± 1/2°	
DRAFT WHERE APPLICABLE MUST REMAIN WITHIN DIMENSIONS	

DIMENSION STYLE MM/IN	
DRAWN BY	DATE
JSCHAFFER	11-07-03
CHECKED BY	DATE
KSAMIEC	11-10-03
APPROVED BY	DATE
MARGULIS	11-17-03
MATERIAL NO.	
SEE CHART	
SIZE	
A	

SCALE	DESIGN UNITS	THIRD ANGLE PROJECTION
2:1	INCH	
TITLE		
KK .156 HEADER ASSEMBLY		
FRICTION LOCK		
RIGHT ANGLE W/O PEGS		
MOLEX INCORPORATED		
DOCUMENT NO.		SHEET NO.
SDA-41792		1 OF *
THIS DRAWING CONTAINS INFORMATION THAT IS PROPRIETARY TO MOLEX INCORPORATED AND SHOULD NOT BE USED WITHOUT WRITTEN PERMISSION		



OPTIONS	Group	A-41792-0002/0018	Group	A-41792-0511/0527	Group	A-41792-0528/0544	Group	A-41792-0562/0578
	Header No:	41790-0002/0018	Header No:	41790-0002/0018	Header No:	41790-0002/0018	Header No:	41790-0002/0018
	Pin No:	2161-37(102)	Pin No:	43294-0569	Pin No:	43294-0570	Pin No:	43294-0570
	Plating:	102 – TIN	Plating:	208 – 15 GOLD	Plating:	228 – 30 GOLD	Plating:	228 – 30 GOLD
	Pin Length L	27.94 / 1.100	Pin Length L	27.94 / 1.100	Pin Length L	27.94 / 1.100	Pin Length L	27.94 / 1.100
	Mating M	11.43 / .450	Mating M	11.43 / .450	Mating M	11.43 / .450	Mating M	11.43 / .450
	Gold Loc G	N/A	Gold Loc G	6.86/ .270	Gold Loc G	6.86/ .270	Gold Loc G	6.86/ .270
	Height Y	5.41 / .213	Height Y	5.41 / .213	Height Y	5.41 / .213	Height Y	5.41 / .213
	PC Tail P	3.96/ .156	PC Tail P	3.96/ .156	PC Tail P	3.96/ .156	PC Tail P	3.96/ .156
	Tin Loc T	OVERALL	Tin Loc T	5.08/ .200	Tin Loc T	5.08/ .200	Tin Loc T	5.08/ .200
	Voided Ckts	NONE	Voided Ckts	NONE	Voided Ckts	NONE	Voided Ckts	2
	Pack Per	PK-41792-002	Pack Per	PK-41792-002	Pack Per	PK-41792-002	Pack Per	PK-41792-002
Ckts	Material No	Engineer Number	Material No	Engineer Number	Material No	Engineer Number	Material No	Engineer Number
2	26-60-5020	A-41792-0002	41792-0511	A-41792-0511	41792-0528	A-41792-0528	41792-0562	A-41792-0562
3	26-60-5030	A-41792-0003	41792-0512	A-41792-0512	41792-0529	A-41792-0529	41792-0563	A-41792-0563
4	26-60-5040	A-41792-0004	41792-0513	A-41792-0513	41792-0530	A-41792-0530	41792-0564	A-41792-0564
5	26-60-5050	A-41792-0005	41792-0514	A-41792-0514	41792-0531	A-41792-0531	41792-0565	A-41792-0565
6	26-60-5060	A-41792-0006	41792-0515	A-41792-0515	41792-0532	A-41792-0532	41792-0566	A-41792-0566
7	26-60-5070	A-41792-0007	41792-0516	A-41792-0516	41792-0533	A-41792-0533	41792-0567	A-41792-0567
8	26-60-5080	A-41792-0008	41792-0517	A-41792-0517	41792-0534	A-41792-0534	41792-0568	A-41792-0568
9	26-60-5090	A-41792-0009	41792-0518	A-41792-0518	41792-0535	A-41792-0535	41792-0569	A-41792-0569
10	26-60-5100	A-41792-0010	41792-0519	A-41792-0519	41792-0536	A-41792-0536	41792-0570	A-41792-0570
11	26-60-5110	A-41792-0011	41792-0520	A-41792-0520	41792-0537	A-41792-0537	41792-0571	A-41792-0571
12	26-60-5120	A-41792-0012	41792-0521	A-41792-0521	41792-0538	A-41792-0538	41792-0572	A-41792-0572
13	26-60-5130	A-41792-0013	41792-0522	A-41792-0522	41792-0539	A-41792-0539	41792-0573	A-41792-0573
14	26-60-5140	A-41792-0014	41792-0523	A-41792-0523	41792-0540	A-41792-0540	41792-0574	A-41792-0574
15	26-60-5150	A-41792-0015	41792-0524	A-41792-0524	41792-0541	A-41792-0541	41792-0575	A-41792-0575
16	26-60-5160	A-41792-0016	41792-0525	A-41792-0525	41792-0542	A-41792-0542	41792-0576	A-41792-0576
17	26-60-5170	A-41792-0017	41792-0526	A-41792-0526	41792-0543	A-41792-0543	41792-0577	A-41792-0577
18	26-60-5180	A-41792-0018	41792-0527	A-41792-0527	41792-0544	A-41792-0544	41792-0578	A-41792-0578

REV:	<u>ECR/ECN INFORMATION:</u>	<u>TITLE:</u>	<u>SHEET No.</u>
<b>H3</b>	EC No.: <b>UCP2006-1776</b>	<b>KK 156 HEADER ASSEMBLY FRICTION LOCK RIGHT ANGLE W/O PEGS</b>	<b>- 2 -</b>
	DATE: <b>4/11/2006</b>		
<u>DOCUMENT NUMBER:</u>	<u>CREATED / REVISED BY:</u>	<u>CHECKED BY:</u>	<u>APPROVED BY:</u>
<b>SDA- 41792</b>	<b>DPETERSON</b>	<b>ADERR</b>	<b>FSMITH</b>

OPTIONS	Group	A-41792-0019/0035	Group	A-41792-0036/0050	Group	A-41792-0051/0067	Group	
	Header No:	41790-0002/0018	Header No:	41790-0003/0018	Header No:	41790-0002/0018	Header No:	
	Pin No:	2161-37(501)	Pin No:	2161-37(102)	Pin No:	2161-64(102)	Pin No:	
	Plating:	501 – GOLD	Plating:	102 – TIN	Plating:	102 - TIN	Plating:	
	Pin Length L	27.94 / 1.100	Pin Length L	27.94 / 1.100	Pin Length L	29.85 / 1.175	Pin Length L	
	Mating M	11.43 / .450	Mating M	11.43 / .450	Mating M	13.28 / .523	Mating M	
	Gold Loc G	OVERALL	Gold Loc G	N/A	Gold Loc G	N/A	Gold Loc G	
	Height Y	5.41 / .213	Height Y	5.41 / .213	Height Y	5.41 / .213	Height Y	
	PC Tail P	3.96/ .156	PC Tail P	3.96/ .156	PC Tail P	4.01 / .158	PC Tail P	
	Tin Loc T	N/A	Tin Loc T	OVERALL	Tin Loc T	OVERALL	Tin Loc T	
	Voided Ckts	NONE	Voided Ckts	4	Voided Ckts	NONE	Voided Ckts	
	Pack Per	PK-41792-002	Pack Per	PK-41792-002	Pack Per	PK-41792-002	Pack Per	
Ckts	Material No	Engineer Number	Material No	Engineer Number	Material No	Engineer Number	Material No	Engineer Number
2	26-61-5020	A-41792-0019						
3	26-61-5030	A-41792-0020						
4	26-61-5040	A-41792-0021	26-61-5043	A-41792-0036	26-60-5041	A-41792-0053		
5	26-61-5050	A-41792-0022	26-61-5053	A-41792-0037				
6	26-61-5060	A-41792-0023	26-61-5063	A-41792-0038				
7	26-61-5070	A-41792-0024	26-61-5073	A-41792-0039				
8	26-61-5080	A-41792-0025	26-61-5083	A-41792-0040				
9	26-61-5090	A-41792-0026	26-61-5093	A-41792-0041				
10	26-61-5100	A-41792-0027	26-61-5103	A-41792-0042				
11	26-61-5110	A-41792-0028	26-61-5113	A-41792-0043				
12	26-61-5120	A-41792-0029	26-61-5123	A-41792-0044				
13	26-61-5130	A-41792-0030	26-61-5133	A-41792-0045				
14	26-61-5140	A-41792-0031	26-61-5143	A-41792-0046				
15	26-61-5150	A-41792-0032	26-61-5153	A-41792-0047				
16	26-61-5160	A-41792-0033	26-61-5163	A-41792-0048				
17	26-61-5170	A-41792-0034	26-61-5173	A-41792-0049				
18	26-61-5180	A-41792-0035	26-61-5173	A-41792-0049				

REV:	<u>ECR/ECN INFORMATION:</u>	<u>TITLE:</u>	<u>SHEET No.</u>
<b>H3</b>	EC No.: <b>UCP2006-1776</b>	<b>KK 156 HEADER ASSEMBLY FRICTION LOCK RIGHT ANGLE W/O PEGS</b>	<b>- 3 -</b>
	DATE: <b>4/11/2006</b>		
<u>DOCUMENT NUMBER:</u>	<u>CREATED / REVISED BY:</u>	<u>CHECKED BY:</u>	<u>APPROVED BY:</u>
<b>SDA- 41792</b>	<b>DPETERSON</b>	<b>ADERR</b>	<b>FSMITH</b>

OPTIONS	Group	A-41792-0198/0213	Group	A-41792-0214/0227	Group	A-41792-0242/0257	Group	A-41792-0341/0352
	Header No:	41790-0002/0018	Header No:	41790-0005/0018	Header No:	41790-0003/0018	Header No:	41790-0007/0018
	Pin No:	2161-37(102)	Pin No:	2161-37(102)	Pin No:	2161-37(102)	Pin No:	2161-37(102)
	Plating:	102 – TIN	Plating:	102 – TIN	Plating:	102 – TIN	Plating:	102 – TIN
	Pin Length L	27.94/ 1.100	Pin Length L	27.94/ 1.100	Pin Length L	27.94/ 1.100	Pin Length L	27.94/ 1.100
	Mating M	11.43 / .450	Mating M	11.43 / .450	Mating M	11.43 / .450	Mating M	11.43 / .450
	Gold Loc G	N/A	Gold Loc G	N/A	Gold Loc G	N/A	Gold Loc G	N/A
	Height Y	5.41 / .213	Height Y	5.41 / .213	Height Y	5.41 / .213	Height Y	5.41 / .213
	PC Tail P	3.96 / .156	PC Tail P	3.96 / .156	PC Tail P	3.96 / .156	PC Tail P	3.96 / .156
	Tin Loc T	OVERALL	Tin Loc T	OVERALL	Tin Loc T	OVERALL	Tin Loc T	OVERALL
	Voided Ckts	2	Voided Ckts	5	Voided Ckts	3	Voided Ckts	7
	Pack Per	PK-41792-002	Pack Per	PK-41792-002	Pack Per	PK-41792-002	Pack Per	PK-41792-002
Ckts	Material No	Engineer Number	Material No	Engineer Number	Material No	Engineer Number	Material No	Engineer Number
2								
3	26-62-5031	A-41792-0198			26-62-5035	A-41792-0242		
4	26-62-5041	A-41792-0199			26-62-5045	A-41792-0243		
5	26-62-5051	A-41792-0200	41792-0214	A-41792-0214	26-62-5055	A-41792-0244		
6	26-62-5061	A-41792-0201	26-62-5060	A-41792-0215	26-62-5065	A-41792-0245		
7	26-62-5071	A-41792-0202	41792-0216	A-41792-0216	26-62-5075	A-41792-0246	41792-0341	A-41792-0341
8	26-62-5081	A-41792-0203	41792-0217	A-41792-0217	26-62-5085	A-41792-0247	41792-0342	A-41792-0342
9	26-62-5091	A-41792-0204	41792-0218	A-41792-0218	26-62-5095	A-41792-0248	41792-0343	A-41792-0343
10	26-62-5101	A-41792-0205	26-62-5100	A-41792-0219	26-62-5105	A-41792-0249	26-62-5104	A-41792-0344
11	26-62-5111	A-41792-0206	41792-0220	A-41792-0220	26-62-5115	A-41792-0250	26-62-5114	A-41792-0345
12	26-62-5121	A-41792-0207	41792-0221	A-41792-0221	26-62-5125	A-41792-0251	41792-0346	A-41792-0346
13	26-62-5131	A-41792-0208	41792-0222	A-41792-0222	26-62-5135	A-41792-0252	41792-0347	A-41792-0347
14	26-62-5141	A-41792-0209	41792-0223	A-41792-0223	26-62-5145	A-41792-0253	41792-0348	A-41792-0348
15	26-62-5151	A-41792-0210	41792-0224	A-41792-0224	26-62-5155	A-41792-0254	41792-0349	A-41792-0349
16	26-62-5161	A-41792-0211	41792-0225	A-41792-0225	26-62-5165	A-41792-0255	41792-0350	A-41792-0350
17	26-62-5171	A-41792-0212	41792-0226	A-41792-0226	26-62-5175	A-41792-0256	41792-0351	A-41792-0351
18	26-62-5181	A-41792-0213	41792-0227	A-41792-0227	26-62-5185	A-41792-0257	41792-0352	A-41792-0352

REV:	<u>ECR/ECN INFORMATION:</u>	<u>TITLE:</u>	<u>SHEET No.</u>
<b>H3</b>	EC No.: <b>UCP2006-1776</b>	<b>KK 156 HEADER ASSEMBLY FRICTION LOCK RIGHT ANGLE W/O PEGS</b>	<b>- 4 -</b>
	DATE: <b>4/11/2006</b>		
<u>DOCUMENT NUMBER:</u>	<u>CREATED / REVISED BY:</u>	<u>CHECKED BY:</u>	<u>APPROVED BY:</u>
<b>SDA- 41792</b>	<b>DPETERSON</b>	<b>ADERR</b>	<b>FSMITH</b>

OPTIONS	Group	A-41792-0460/0471	Group	A-41792-0472/0483	Group	A-41792-0484/0493	Group	A-41792-0579/0595
	Header No:	41790-0007/0018	Header No:	41790-0007/0018	Header No:	41790-0009/0018	Header No:	41790-0002/0018
	Pin No:	2161-37(102)	Pin No:	2161-37(102)	Pin No:	2161-37(102)	Pin No:	2161-37(154)
	Plating:	102 – TIN	Plating:	102 – TIN	Plating:	102 – TIN	Plating:	154 – TIN
	Pin Length L	27.94 / 1.100	Pin Length L	27.94 / 1.100	Pin Length L	27.94 / 1.100	Pin Length L	27.94 / 1.100
	Mating M	11.43 / .450	Mating M	11.43 / .450	Mating M	11.43 / .450	Mating M	11.43 / .450
	Gold Loc G	N/A	Gold Loc G	N/A	Gold Loc G	N/A	Gold Loc G	N/A
	Height Y	5.41 / .213	Height Y	5.41 / .213	Height Y	5.41 / .213	Height Y	5.41 / .213
	PC Tail P	3.96 / .156	PC Tail P	3.96 / .156	PC Tail P	3.96 / .156	PC Tail P	3.96 / .156
	Tin Loc T	OVERALL	Tin Loc T	OVERALL	Tin Loc T	OVERALL	Tin Loc T	OVERALL
	Voided Ckts	2, 7	Voided Ckts	4, 7	Voided Ckts	2, 5, 9	Voided Ckts	NONE
	Pack Per	PK-41792-002	Pack Per	PK-41792-002	Pack Per	PK-41792-002	Pack Per	PK-41792-002
Ckts	Material No	Engineer Number	Material No	Engineer Number	Material No	Engineer Number	Material No	Engineer Number
2							50-29-1904	A-41792-0579
3							50-29-1905	A-41792-0580
4							50-29-1906	A-41792-0581
5							50-29-1907	A-41792-0582
6							50-29-1908	A-41792-0583
7	41792-0460	A-41792-0460		A-41792-0472			50-29-1909	A-41792-0584
8	41792-0461	A-41792-0461	26-60-5087	A-41792-0473			50-29-1910	A-41792-0585
9	26-60-5096	A-41792-0462		A-41792-0474		A-41792-0484	50-29-1911	A-41792-0586
10	41792-0463	A-41792-0463		A-41792-0475		A-41792-0485	50-29-1912	A-41792-0587
11	41792-0464	A-41792-0464		A-41792-0476		A-41792-0486	50-29-1913	A-41792-0588
12	41792-0465	A-41792-0465		A-41792-0477	26-60-5128	A-41792-0487	50-29-1914	A-41792-0589
13	41792-0466	A-41792-0466		A-41792-0478		A-41792-0488	50-29-1915	A-41792-0590
14	41792-0467	A-41792-0467		A-41792-0479		A-41792-0489	50-29-1916	A-41792-0591
15	41792-0468	A-41792-0468		A-41792-0480		A-41792-0490	50-29-1917	A-41792-0592
16	41792-0469	A-41792-0469		A-41792-0481		A-41792-0491	50-29-1918	A-41792-0593
17	41792-0470	A-41792-0470		A-41792-0482		A-41792-0492	50-29-1919	A-41792-0594
18	41792-0471	A-41792-0471		A-41792-0483		A-41792-0493	50-29-1920	A-41792-0595

REV:	<u>ECR/ECN INFORMATION:</u>	<u>TITLE:</u>	<u>SHEET No.</u>
<b>H3</b>	EC No.: <b>UCP2006-1776</b>	<b>KK 156 HEADER ASSEMBLY FRICTION LOCK RIGHT ANGLE W/O PEGS</b>	<b>- 5 -</b>
	DATE: <b>4/11/2006</b>		
<u>DOCUMENT NUMBER:</u>	<u>CREATED / REVISED BY:</u>	<u>CHECKED BY:</u>	<u>APPROVED BY:</u>
<b>SDA- 41792</b>	<b>DPETERSON</b>	<b>ADERR</b>	<b>FSMITH</b>

OPTIONS	Group	A-41792-0596/0612	Group	A-41792-0613/0629	Group	A-41792-0484/0493	Group	
	Header No:	41790-0007/0018	Header No:	41790-0009/0018	Header No:	41790-0009/0018	Header No:	
	Pin No:	2161-37(154)	Pin No:	2161-37(154)	Pin No:	2161-37(154)	Pin No:	
	Plating:	154 – TIN	Plating:	154 – TIN	Plating:	154 – TIN	Plating:	
	Pin Length L	27.94 / 1.100	Pin Length L	27.94 / 1.100	Pin Length L	27.94 / 1.100	Pin Length L	
	Mating M	11.43 / .450	Mating M	11.43 / .450	Mating M	11.43 / .450	Mating M	
	Gold Loc G	N/A	Gold Loc G	N/A	Gold Loc G	N/A	Gold Loc G	
	Height Y	5.41 / .213	Height Y	5.41 / .213	Height Y	5.41 / .213	Height Y	
	PC Tail P	3.96 / .156	PC Tail P	3.96 / .156	PC Tail P	3.96 / .156	PC Tail P	
	Tin Loc T	OVERALL	Tin Loc T	OVERALL	Tin Loc T	OVERALL	Tin Loc T	
	Voided Ckts	2, 7	Voided Ckts	2, 5, 9	Voided Ckts	2, 5, 9	Voided Ckts	
	Pack Per	PK-41792-002	Pack Per	PK-41792-002	Pack Per	PK-41792-002	Pack Per	
Ckts	Material No	Engineer Number	Material No	Engineer Number	Material No	Engineer Number	Material No	Engineer Number
2								
3								
4								
5								
6								
7	50-29-1926	A-41792-0601						
8	50-29-1927	A-41792-0602						
9	50-29-1928	A-41792-0603	50-29-1945	A-41792-0620		A-41792-0630		
10	50-29-1929	A-41792-0604	50-29-1946	A-41792-0621		A-41792-0631		
11	50-29-1930	A-41792-0605	50-29-1947	A-41792-0622		A-41792-0632		
12	50-29-1931	A-41792-0606	50-29-1948	A-41792-0623	41792-0633	A-41792-0633		
13	50-29-1932	A-41792-0607	50-29-1949	A-41792-0624		A-41792-0634		
14	50-29-1933	A-41792-0608	50-29-1950	A-41792-0625		A-41792-0635		
15	50-29-1934	A-41792-0609	50-29-1951	A-41792-0626		A-41792-0636		
16	50-29-1935	A-41792-0610	50-29-1952	A-41792-0627		A-41792-0637		
17	50-29-1936	A-41792-0611	50-29-1953	A-41792-0628		A-41792-0638		
18	50-29-1937	A-41792-0612	50-29-1954	A-41792-0629		A-41792-0639		

REV:	<u>ECR/ECN INFORMATION:</u>	<u>TITLE:</u>	<u>SHEET No.</u>
<b>H3</b>	EC No.: <b>UCP2006-1776</b>	<b>KK 156 HEADER ASSEMBLY FRICTION LOCK RIGHT ANGLE W/O PEGS</b>	<b>- 6 -</b>
	DATE: <b>4/11/2006</b>		
<u>DOCUMENT NUMBER:</u>	<u>CREATED / REVISED BY:</u>	<u>CHECKED BY:</u>	<u>APPROVED BY:</u>
<b>SDA- 41792</b>	<b>DPETERSON</b>	<b>ADERR</b>	<b>FSMITH</b>