

RECOMMENDED HOLE LAYOUT FOR .070/(1.78) MAX. THICK P. C. BOARD

VIEWED FROM COMPONENT SIDE

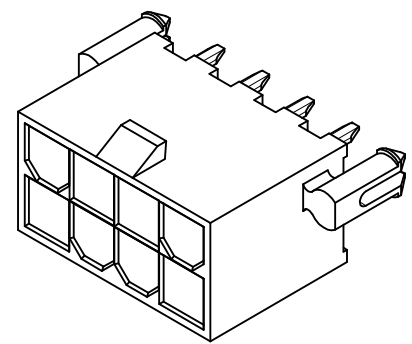

CIRCUIT SIZE	DIM. "A"	DIM. "B"	DIM. "C"
2	—	.21 (5.4)	.370 (9.40)
4	.17 (4.2)	.38 (9.6)	.535 (13.60)
6	.33 (8.4)	.54 (13.8)	.701 (17.80)
8	.50 (12.6)	.71 (18.0)	.866 (22.00)
10	.66 (16.8)	.87 (22.2)	1.031 (26.20)
12	.83 (21.0)	1.04 (26.4)	1.197 (30.40)
14	.99 (25.2)	1.20 (30.6)	1.362 (34.60)
16	1.16 (29.4)	1.37 (34.8)	1.528 (38.80)
18	1.32 (33.6)	1.54 (39.0)	1.693 (43.00)
20	1.49 (37.8)	1.70 (43.2)	1.858 (47.20)
22	1.65 (42.0)	1.87 (47.4)	2.024 (51.40)
24	1.82 (46.2)	2.03 (51.6)	2.189 (55.60)

LEGEND:

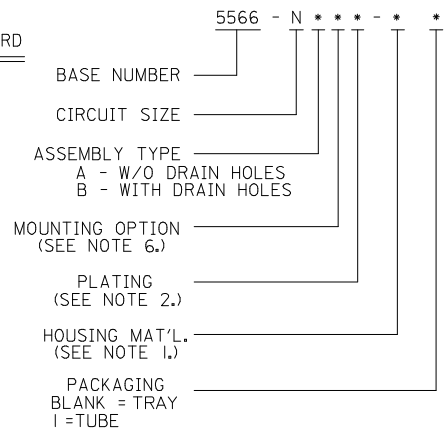

NOTES:

- HOUSING MATERIAL:
 - "BLANK" - NYLON 6/6, UNFILLED U.L. 94V-2, COLOR: NATURAL.
 - 210 - NYLON 6/6, UNFILLED U.L. 94V-0, COLOR: NATURAL.
 - BL - NYLON 6/6, UNFILLED U.L. 94V-2, COLOR: BLACK.
- TERMINAL MATERIAL: BRASS
- TERMINAL PLATING:
 - "BLANK" - .000035/(.00090) MIN. TIN OVER .000020/(.00050) MIN. COPPER.
 - GS - .000030/(.00076) MIN. SELECT GOLD .000100/(.00254) MIN. SELECT MATTE TIN OVER .000050/(.00127) MIN. NICKEL OVERALL.
 - GS2 - .000015/(.00038) MIN. SELECT GOLD AND .000100/(.00254) MIN. SELECT MATTE TIN OVER .000050/(.00127) MIN. NICKEL OVERALL.
 - S - .000100/(.00254) MIN. TIN OVER .000050/(.00127) MIN. NICKEL.
- PRODUCT SPECIFICATION: PS-5556-001
- PACKAGING: SEE CHARTS
- PART MATES WITH MINI-FIT JR. RECEPTACLE #5557.
- MOUNTING OPTIONS:
 - "BLANK" - NO MOUNTING (SEE SD-5566-002 DWG.)
 - 2 - PEG MOUNT
- PART CONFORMS TO CLASS "B" REQUIREMENTS OF COSMETIC SPECIFICATION PS-45499-002
- ANTI-SHINGLING RIB MAY OR MAY NOT APPEAR ON HOUSINGS.
- CONNECTORS ARE NOT TO BE MATED OR UNMATED WHILE CIRCUITS ARE LIVE.
- PARTS ARE NOT DESIGNED FOR CURRENT SHARING.

ADD ISO VIEW EC NO: UCP2013-0706 2012/08/21 DRWINANGUYEN CHKD:JBELL 2012/08/21 APPR:FSMITH 2012/09/05 R5	QUALITY SYMBOLS ∇=0 ∇=0 ∇=0	GENERAL TOLERANCES (UNLESS SPECIFIED)		DIMENSION STYLE IN/MM		SCALE 4:1	DESIGN UNITS METRIC	THIRD ANGLE PROJECTION		
		mm	INCH	DRAWN BY RJF	DATE 8/19/87	MINI-FIT JR. VERTICAL HEADER ASSEMBLIES WITH MOUNTING PEGS MOLEX INCORPORATED DOCUMENT NO. SDA-5566-N*2*-* SHEET NO. 1 OF 4				
		4 PLACES ± --- ± ---	3 PLACES ± --- ± .015	CHECKED BY GT	DATE 8/19/87					
		2 PLACES ± 0.38 ± .020	1 PLACE ± 0.50 ± ---	APPROVED BY FSMITH	DATE 2012/01/10					
		ANGULAR ±1/2°		MATERIAL NO. SEE SHTS 2-4		THIS DRAWING CONTAINS INFORMATION THAT IS PROPRIETARY TO MOLEX INCORPORATED AND SHOULD NOT BE USED WITHOUT WRITTEN PERMISSION				
DRAFT WHERE APPLICABLE MUST REMAIN WITHIN DIMENSIONS		SIZE C								

13	12	11	10	9	8	7	6	5	4	3	2	1			
PLATING:		35 M.I. TIN		PLATING:		35 M.I. TIN		PLATING:		30 M.I. GOLD		PLATING:		30 M.I. GOLD	
DRAIN HOLES:		WITHOUT DRAIN HOLES		DRAIN HOLES:		WITHOUT DRAIN HOLES		DRAIN HOLES:		WITHOUT DRAIN HOLES		DRAIN HOLES:		WITHOUT DRAIN HOLES	
MTG. OPTION:		WITH PEGS		MTG. OPTION:		WITH PEGS		MTG. OPTION:		WITH PEGS		MTG. OPTION:		WITH PEGS	
HOUSING MAT'L:		NYLON 6/6 94V-2 NATURAL		HOUSING MAT'L:		NYLON 6/6 94V-0 NATURAL		HOUSING MAT'L:		NYLON 6/6 94V-2 NATURAL		HOUSING MAT'L:		NYLON 6/6 94V-0 NATURAL	
PACKAGING:		PK-5566-001		PACKAGING:		PK-5566-001		PACKAGING:		PK-5566-001		PACKAGING:		PK-5566-001	
PART NO.	ENG NO.	CKTS		PART NO.	ENG NO.	CKTS		PART NO.	ENG NO.	CKTS		PART NO.	ENG NO.	CKTS	
39-29-9023	5566 -02A2	2		39-29-9027	5566 -02A2-210	2		39-29-9025	5566 -02A2GS	2		39-29-9029	5566 -02A2GS-210	2	
39-29-9043	5566 -04A2	4		39-29-9047	5566 -04A2-210	4		39-29-9045	5566 -04A2GS	4		39-29-9049	5566 -04A2GS-210	4	
39-29-9063	5566 -06A2	6		39-29-9067	5566 -06A2-210	6		39-29-9065	5566 -06A2GS	6		39-29-9069	5566 -06A2GS-210	6	
39-29-9083	5566 -08A2	8		39-29-9087	5566 -08A2-210	8		39-29-9085	5566 -08A2GS	8		39-29-9089	5566 -08A2GS-210	8	
39-29-9103	5566 -10A2	10		39-29-9107	5566 -10A2-210	10		39-29-9105	5566 -10A2GS	10		39-29-9109	5566 -10A2GS-210	10	
39-29-9123	5566 -12A2	12		39-29-9127	5566 -12A2-210	12		39-29-9125	5566 -12A2GS	12		39-29-9129	5566 -12A2GS-210	12	
39-29-9143	5566 -14A2	14		39-29-9147	5566 -14A2-210	14		39-29-9145	5566 -14A2GS	14		39-29-9149	5566 -14A2GS-210	14	
39-29-9163	5566 -16A2	16		39-29-9167	5566 -16A2-210	16		39-29-9165	5566 -16A2GS	16		39-29-9169	5566 -16A2GS-210	16	
39-29-9183	5566 -18A2	18		39-29-9187	5566 -18A2-210	18		39-29-9185	5566 -18A2GS	18		39-29-9189	5566 -18A2GS-210	18	
39-29-9203	5566 -20A2	20		39-29-9207	5566 -20A2-210	20		39-29-9205	5566 -20A2GS	20		39-29-9209	5566 -20A2GS-210	20	
39-29-9223	5566 -22A2	22		39-29-9227	5566 -22A2-210	22		39-29-9225	5566 -22A2GS	22		39-29-9229	5566 -22A2GS-210	22	
39-29-9243	5566 -24A2	24		39-29-9247	5566 -24A2-210	24		39-29-9245	5566 -24A2GS	24		39-29-9249	5566 -24A2GS-210	24	
	-				-				-				-		
	-				-				-				-		

13	12	11	10	9	8	7	6	5	4	3	2	1			
PLATING:		35 M.I. TIN		PLATING:		35 M.I. TIN		PLATING:		30 M.I. GOLD		PLATING:		30 M.I. GOLD	
DRAIN HOLES:		WITH DRAIN HOLES		DRAIN HOLES:		WITH DRAIN HOLES		DRAIN HOLES:		WITH DRAIN HOLES		DRAIN HOLES:		WITH DRAIN HOLES	
MTG. OPTION:		WITH PEGS		MTG. OPTION:		WITH PEGS		MTG. OPTION:		WITH PEGS		MTG. OPTION:		WITH PEGS	
HOUSING MAT'L:		NYLON 6/6 94V-2 NATURAL		HOUSING MAT'L:		NYLON 6/6 94V-0 NATURAL		HOUSING MAT'L:		NYLON 6/6 94V-2 NATURAL		HOUSING MAT'L:		NYLON 6/6 94V-0 NATURAL	
PACKAGING:		PK-5566-001		PACKAGING:		PK-5566-001		PACKAGING:		PK-5566-001		PACKAGING:		PK-5566-001	
PART NO.	ENG NO.	CKTS		PART NO.	ENG NO.	CKTS		PART NO.	ENG NO.	CKTS		PART NO.	ENG NO.	CKTS	
39-29-9022	5566 -02B2	2		39-29-9026	5566 -02B2-210	2		39-29-9024	5566 -02B2GS	2		39-28-9028	5566 -02B2GS-210	2	
39-29-9042	5566 -04B2	4		39-29-9046	5566 -04B2-210	4		39-29-9044	5566 -04B2GS	4		39-28-9048	5566 -04B2GS-210	4	
39-29-9062	5566 -06B2	6		39-29-9066	5566 -06B2-210	6		39-29-9064	5566 -06B2GS	6		39-28-9068	5566 -06B2GS-210	6	
39-29-9082	5566 -08B2	8		39-29-9086	5566 -08B2-210	8		39-29-9084	5566 -08B2GS	8		39-28-9088	5566 -08B2GS-210	8	
39-29-9102	5566 -10B2	10		39-29-9106	5566 -10B2-210	10		39-29-9104	5566 -10B2GS	10		39-28-9108	5566 -10B2GS-210	10	
39-29-9122	5566 -12B2	12		39-29-9126	5566 -12B2-210	12		39-29-9124	5566 -12B2GS	12		39-28-9128	5566 -12B2GS-210	12	
39-29-9142	5566 -14B2	14		39-29-9146	5566 -14B2-210	14		39-29-9144	5566 -14B2GS	14		39-28-9148	5566 -14B2GS-210	14	
39-29-9162	5566 -16B2	16		39-29-9166	5566 -16B2-210	16		39-29-9164	5566 -16B2GS	16		39-28-9168	5566 -16B2GS-210	16	
39-29-9182	5566 -18B2	18		39-29-9186	5566 -18B2-210	18		39-29-9184	5566 -18B2GS	18		39-28-9188	5566 -18B2GS-210	18	
39-29-9202	5566 -20B2	20		39-29-9206	5566 -20B2-210	20		39-29-9204	5566 -20B2GS	20		39-28-9208	5566 -20B2GS-210	20	
39-29-9222	5566 -22B2	22		39-29-9226	5566 -22B2-210	22		39-29-9224	5566 -22B2GS	22		39-28-9228	5566 -22B2GS-210	22	
39-29-9242	5566 -24B2	24		39-29-9246	5566 -24B2-210	24		39-29-9244	5566 -24B2GS	24		39-28-9248	5566 -24B2GS-210	24	
	-				-				-				-		
	-				-				-				-		

SEE SHEET 1 EC NO: UCP2013-0706 DRAWN: NGUYEN 2012/08/21 CHKD: JHELL 2012/08/21 APPR: FSMITH 2012/09/05 R5	QUALITY SYMBOLS 	GENERAL TOLERANCES (UNLESS SPECIFIED) <table border="1"> <tr> <th></th> <th>mm</th> <th>INCH</th> </tr> <tr> <td>4 PLACES</td> <td>± .005</td> <td>± .0004</td> </tr> <tr> <td>3 PLACES</td> <td>± .005</td> <td>± .015</td> </tr> <tr> <td>2 PLACES</td> <td>± 0.38</td> <td>± .020</td> </tr> <tr> <td>1 PLACE</td> <td>± 0.50</td> <td>± .020</td> </tr> <tr> <td colspan="3">ANGULAR ± 1/2°</td> </tr> </table>		mm	INCH	4 PLACES	± .005	± .0004	3 PLACES	± .005	± .015	2 PLACES	± 0.38	± .020	1 PLACE	± 0.50	± .020	ANGULAR ± 1/2°			DIMENSION STYLE IN/MM DRAWN BY: RJF DATE: 8/19/87 CHECKED BY: GT DATE: 8/19/87 APPROVED BY: FSMITH DATE: 2012/01/10	SCALE: 1:1 DESIGN UNITS: METRIC THIRD ANGLE PROJECTION	TITLE: MINI-FIT JR. VERTICAL HEADER ASSEMBLIES WITH MOUNTING PEGS	MOLEX INCORPORATED	MATERIAL NO. SDA-5566-N*2*-* SHEET NO. 2 OF 4
		mm	INCH																						
	4 PLACES	± .005	± .0004																						
	3 PLACES	± .005	± .015																						
	2 PLACES	± 0.38	± .020																						
1 PLACE	± 0.50	± .020																							
ANGULAR ± 1/2°																									
DRAFT WHERE APPLICABLE MUST REMAIN WITHIN DIMENSIONS		SEE CHART																							
THIS DRAWING CONTAINS INFORMATION THAT IS PROPRIETARY TO MOLEX INCORPORATED AND SHOULD NOT BE USED WITHOUT WRITTEN PERMISSION																									

13	12	11	10	9	8	7	6	5	4	3	2	1
----	----	----	----	---	---	---	---	---	---	---	---	---







13	12	11	10	9	8	7	6	5	4	3	2	1			
PLATING:		100 M.I. BRIGHT TIN		PLATING:		100 M.I. BRIGHT TIN		PLATING:		15 M.I. SELECT GOLD		PLATING:		15 M.I. SELECT GOLD	
DRAIN HOLES:		WITHOUT DRAIN HOLES		DRAIN HOLES:		WITHOUT DRAIN HOLES		DRAIN HOLES:		WITHOUT DRAIN HOLES		DRAIN HOLES:		WITHOUT DRAIN HOLES	
MTG. OPTION:		WITH PEGS		MTG. OPTION:		WITH PEGS		MTG. OPTION:		WITH PEGS		MTG. OPTION:		WITH PEGS	
HOUSING MAT'L:		NYLON 6/6 94V-2 NATURAL		HOUSING MAT'L:		NYLON 6/6 94V-0 NATURAL		HOUSING MAT'L:		NYLON 6/6 94V-2 NATURAL		HOUSING MAT'L:		NYLON 6/6 94V-0 NATURAL	
PACKAGING:		PK-5566-001		PACKAGING:		PK-5566-001		PACKAGING:		PK-5566-001		PACKAGING:		PK-5566-001	
PART NO.	ENG NO.	CKTS		PART NO.	ENG NO.	CKTS		PART NO.	ENG NO.	CKTS		PART NO.	ENG NO.	CKTS	
39-30-6025	5566 -02A2S	2		39-30-6026	5566 -02A2S-210	2		39-30-0026	5566 -02A2GS2	2		39-30-0027	5566 -02A2GS2-210	2	
39-30-6045	5566 -04A2S	4		39-30-6046	5566 -04A2S-210	4		39-30-0046	5566 -04A2GS2	4		39-30-0047	5566 -04A2GS2-210	4	
39-30-6065	5566 -06A2S	6		39-30-6066	5566 -06A2S-210	6		39-30-0066	5566 -06A2GS2	6		39-30-0067	5566 -06A2GS2-210	6	
39-30-6085	5566 -08A2S	8		39-30-6086	5566 -08A2S-210	8		39-30-0086	5566 -08A2GS2	8		39-30-0087	5566 -08A2GS2-210	8	
39-30-6105	5566 -10A2S	10		39-30-6106	5566 -10A2S-210	10		39-30-0106	5566 -10A2GS2	10		39-30-0107	5566 -10A2GS2-210	10	
39-30-6125	5566 -12A2S	12		39-30-6126	5566 -12A2S-210	12		39-30-0126	5566 -12A2GS2	12		39-30-0127	5566 -12A2GS2-210	12	
39-30-6145	5566 -14A2S	14		39-30-6146	5566 -14A2S-210	14		39-30-0146	5566 -14A2GS2	14		39-30-0147	5566 -14A2GS2-210	14	
39-30-6165	5566 -16A2S	16		39-30-6166	5566 -16A2S-210	16		39-30-0166	5566 -16A2GS2	16		39-30-0167	5566 -16A2GS2-210	16	
39-30-6185	5566 -18A2S	18		39-30-6186	5566 -18A2S-210	18		39-30-0186	5566 -18A2GS2	18		39-30-0187	5566 -18A2GS2-210	18	
39-30-6205	5566 -20A2S	20		39-30-6206	5566 -20A2S-210	20		39-30-0206	5566 -20A2GS2	20		39-30-0207	5566 -20A2GS2-210	20	
39-30-6225	5566 -22A2S	22		39-30-6226	5566 -22A2S-210	22		39-30-0226	5566 -22A2GS2	22		39-30-0227	5566 -22A2GS2-210	22	
39-30-6245	5566 -24A2S	24		39-30-6246	5566 -24A2S-210	24		39-30-0246	5566 -24A2GS2	24		39-30-0247	5566 -24A2GS2-210	24	
	-				-				-				-		
	-				-				-				-		

PLATING:		100 M.I. BRIGHT TIN		PLATING:		100 M.I. BRIGHT TIN		PLATING:		15 M.I. SELECT GOLD		PLATING:		15 M.I. SELECT GOLD	
DRAIN HOLES:		WITH DRAIN HOLES		DRAIN HOLES:		WITH DRAIN HOLES		DRAIN HOLES:		WITH DRAIN HOLES		DRAIN HOLES:		WITH DRAIN HOLES	
MTG. OPTION:		WITH PEGS		MTG. OPTION:		WITH PEGS		MTG. OPTION:		WITH PEGS		MTG. OPTION:		WITH PEGS	
HOUSING MAT'L:		NYLON 6/6 94V-2 NATURAL		HOUSING MAT'L:		NYLON 6/6 94V-0 NATURAL		HOUSING MAT'L:		NYLON 6/6 94V-2 NATURAL		HOUSING MAT'L:		NYLON 6/6 94V-0 NATURAL	
PACKAGING:		PK-5566-001		PACKAGING:		PK-5566-001		PACKAGING:		PK-5566-001		PACKAGING:		PK-5566-001	
PART NO.	ENG NO.	CKTS		PART NO.	ENG NO.	CKTS		PART NO.	ENG NO.	CKTS		PART NO.	ENG NO.	CKTS	
39-30-6027	5566 -02B2S	2		39-30-6028	5566 -02B2S-210	2		39-30-0028	5566 -02B2GS2	2		39-30-0029	5566 -02B2GS2-210	2	
39-30-6047	5566 -04B2S	4		39-30-6048	5566 -04B2S-210	4		39-30-0048	5566 -04B2GS2	4		39-30-0049	5566 -04B2GS2-210	4	
39-30-6067	5566 -06B2S	6		39-30-6068	5566 -06B2S-210	6		39-30-0068	5566 -06B2GS2	6		39-30-0069	5566 -06B2GS2-210	6	
39-30-6087	5566 -08B2S	8		39-30-6088	5566 -08B2S-210	8		39-30-0088	5566 -08B2GS2	8		39-30-0089	5566 -08B2GS2-210	8	
39-30-6107	5566 -10B2S	10		39-30-6108	5566 -10B2S-210	10		39-30-0108	5566 -10B2GS2	10		39-30-0109	5566 -10B2GS2-210	10	
39-30-6127	5566 -12B2S	12		39-30-6128	5566 -12B2S-210	12		39-30-0128	5566 -12B2GS2	12		39-30-0129	5566 -12B2GS2-210	12	
39-30-6147	5566 -14B2S	14		39-30-6148	5566 -14B2S-210	14		39-30-0148	5566 -14B2GS2	14		39-30-0149	5566 -14B2GS2-210	14	
39-30-6167	5566 -16B2S	16		39-30-6168	5566 -16B2S-210	16		39-30-0168	5566 -16B2GS2	16		39-30-0169	5566 -16B2GS2-210	16	
39-30-6187	5566 -18B2S	18		39-30-6188	5566 -18B2S-210	18		39-30-0188	5566 -18B2GS2	18		39-30-0189	5566 -18B2GS2-210	18	
39-30-6207	5566 -20B2S	20		39-30-6208	5566 -20B2S-210	20		39-30-0208	5566 -20B2GS2	20		39-30-0209	5566 -20B2GS2-210	20	
39-30-6227	5566 -22B2S	22		39-30-6228	5566 -22B2S-210	22		39-30-0228	5566 -22B2GS2	22		39-30-0229	5566 -22B2GS2-210	22	
39-30-6247	5566 -24B2S	24		39-30-6248	5566 -24B2S-210	24		39-30-0248	5566 -24B2GS2	24		39-30-0249	5566 -24B2GS2-210	24	
	-				-				-				-		
	-				-				-				-		

SEE SHEET 1 EC NO: UCP2013-0706 DRAWN: NGUYEN 2012/08/21 CHKD: J.BELL 2012/08/21 APPR: FSMITH 2012/09/05 R5	QUALITY SYMBOLS ▽=0 ▽=0 ▽=0	GENERAL TOLERANCES (UNLESS SPECIFIED)		DIMENSION STYLE IN/MM		SCALE 1:1	DESIGN UNITS METRIC	THIRD ANGLE PROJECTION			
		4 PLACES ± --- ± ---	3 PLACES ± --- ± .015	2 PLACES ± 0.38 ± .020	1 PLACE ± 0.50 ± ---	DRAWN BY RJF	DATE 8/19/87	TITLE MINI-FIT JR. VERTICAL HEADER ASSEMBLIES WITH MOUNTING PEGS			
		ANGULAR ± 1/2°				CHECKED BY GT	DATE 8/19/87				
		DRAFT WHERE APPLICABLE MUST REMAIN WITHIN DIMENSIONS				APPROVED BY FSMITH		DATE 2012/01/10	MOLEX INCORPORATED		SHEET NO. 3 OF 4
				MATERIAL NO. SEE CHART		DOCUMENT NO. SDA-5566-N*2*-*					
THIS DRAWING CONTAINS INFORMATION THAT IS PROPRIETARY TO MOLEX INCORPORATED AND SHOULD NOT BE USED WITHOUT WRITTEN PERMISSION											

13			12			11			10			9			8			7			6			5			4			3			2			1		
PLATING:			35 M.I. TIN			PLATING:			35 M.I. TIN			PLATING:						PLATING:																				
DRAIN HOLES:			WITHOUT DRAIN HOLES			DRAIN HOLES:			WITHOUT DRAIN HOLES			DRAIN HOLES:						DRAIN HOLES:																				
MTG. OPTION:			WITH PEGS			MTG. OPTION:			WITH PEGS			MTG. OPTION:						MTG. OPTION:																				
HOUSING MAT'L:			NYLON 6/6 94V-2 (BLACK)			HOUSING MAT'L:			94V-2 NATURAL			HOUSING MAT'L:						HOUSING MAT'L:																				
PACKAGING:			PK-5566-001			PACKAGING:			TUBE			PACKAGING:						PACKAGING:																				
PART NO.	ENG NO.	CKTS	PART NO.	ENG NO.	CKTS	PART NO.	ENG NO.	CKTS	PART NO.	ENG NO.	CKTS	PART NO.	ENG NO.	CKTS	PART NO.	ENG NO.	CKTS																					
39-31-9028	5566 -02A2-BL	2	39-34-8028	5566 -02A2-1	2																																	
39-31-9048	5566 -04A2-BL	4	39-34-8048	5566 -04A2-1	4																																	
39-31-9068	5566 -06A2-BL	6	39-34-8068	5566 -06A2-1	6																																	
39-31-9088	5566 -08A2-BL	8	39-34-8088	5566 -08A2-1	8																																	
39-31-9108	5566 -10A2-BL	10	39-34-8108	5566 -10A2-1	10																																	
39-31-9128	5566 -12A2-BL	12	39-34-8128	5566 -12A2-1	12																																	
39-31-9148	5566 -14A2-BL	14	39-34-8148	5566 -14A2-1	14																																	
39-31-9168	5566 -16A2-BL	16	39-34-8168	5566 -16A2-1	16																																	
39-31-9188	5566 -18A2-BL	18	39-34-8188	5566 -18A2-1	18																																	
39-31-9208	5566 -20A2-BL	20	39-34-8208	5566 -20A2-1	20																																	
39-31-9228	5566 -22A2-BL	22	39-34-8228	5566 -22A2-1	22																																	
39-31-9248	5566 -24A2-BL	24	39-34-8248	5566 -24A2-1	24																																	

PLATING:						PLATING:						PLATING:					
DRAIN HOLES:						DRAIN HOLES:						DRAIN HOLES:					
MTG. OPTION:						MTG. OPTION:						MTG. OPTION:					
HOUSING MAT'L:						HOUSING MAT'L:						HOUSING MAT'L:					
PACKAGING:						PACKAGING:						PACKAGING:					
PART NO.	ENG NO.	CKTS	PART NO.	ENG NO.	CKTS	PART NO.	ENG NO.	CKTS	PART NO.	ENG NO.	CKTS	PART NO.	ENG NO.	CKTS			
	-			-			-			-			-				
	-			-			-			-			-				
	-			-			-			-			-				
	-			-			-			-			-				
	-			-			-			-			-				
	-			-			-			-			-				
	-			-			-			-			-				
	-			-			-			-			-				
	-			-			-			-			-				
	-			-			-			-			-				
	-			-			-			-			-				
	-			-			-			-			-				

SEE SHEET 1 EC NO: UCP2013-0706 DRAWING: NGUYEN 2012/08/21 CHKD: J.BELL 2012/08/21 APPR: F.SMITH 2012/09/05	QUALITY SYMBOLS  = 0  = 0  = 0	GENERAL TOLERANCES (UNLESS SPECIFIED) <table border="1"> <tr> <th></th> <th>mm</th> <th>INCH</th> </tr> <tr> <td>4 PLACES</td> <td>± .015</td> <td>± .0006</td> </tr> <tr> <td>3 PLACES</td> <td>± .020</td> <td>± .0008</td> </tr> <tr> <td>2 PLACES</td> <td>± 0.38</td> <td>± .015</td> </tr> <tr> <td>1 PLACE</td> <td>± 0.50</td> <td>± .020</td> </tr> </table>			mm	INCH	4 PLACES	± .015	± .0006	3 PLACES	± .020	± .0008	2 PLACES	± 0.38	± .015	1 PLACE	± 0.50	± .020	DIMENSION STYLE IN/MM DRAWN BY: RJF DATE: 8/19/87 CHECKED BY: GT DATE: 8/19/87		SCALE: 1:1 DESIGN UNITS: METRIC  THIRD ANGLE PROJECTION	
			mm	INCH																		
		4 PLACES	± .015	± .0006																		
		3 PLACES	± .020	± .0008																		
2 PLACES	± 0.38	± .015																				
1 PLACE	± 0.50	± .020																				
DRAFT WHERE APPLICABLE MUST REMAIN WITHIN DIMENSIONS		APPROVED BY: F.SMITH DATE: 2012/01/10 MATERIAL NO. SEE CHART		TITLE: MINI-FIT JR. VERTICAL HEADER ASSEMBLIES WITH MOUNTING PEGS  MOLEX INCORPORATED																		
R5		SIZE:  THIS DRAWING CONTAINS INFORMATION THAT IS PROPRIETARY TO MOLEX INCORPORATED AND SHOULD NOT BE USED WITHOUT WRITTEN PERMISSION		DOCUMENT NO. SDA-5566-N*2*-* SHEET NO. 4 OF 4																		