

CIRCUIT SIZE	DIM. "A"	DIM. "B"
6	.54 (13.8)	.33 (8.4)
8	.71 (18.0)	.50 (12.6)
10	.87 (22.2)	.66 (16.8)
12	1.04 (26.4)	.83 (21.0)
14	1.20 (30.6)	.99 (25.2)
16	1.37 (34.8)	1.16 (29.4)
18	1.54 (39.0)	1.32 (33.6)
20	1.70 (43.2)	1.49 (37.8)
22	1.87 (47.4)	1.65 (42.0)
24	2.03 (51.6)	1.82 (46.2)

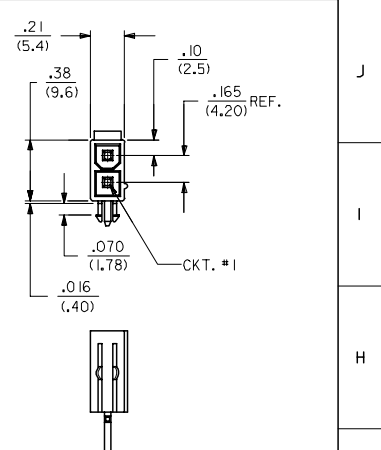
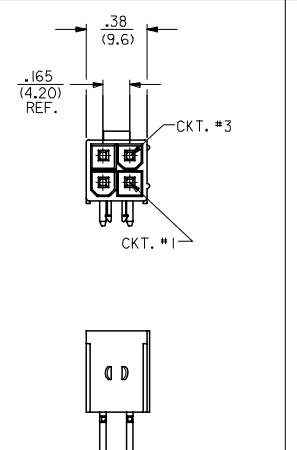
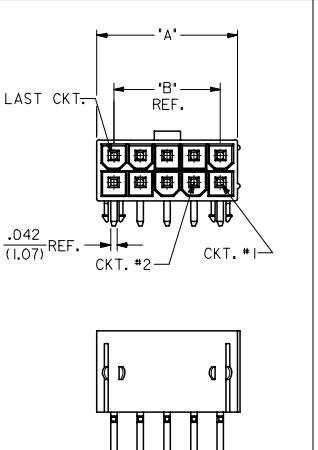
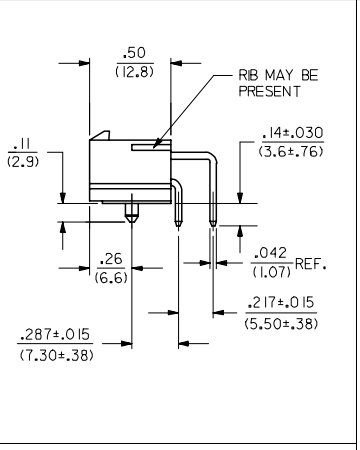

NOTES:

1) MATERIAL:
HOUSING:
"BLANK" = NYLON (PA66), UNFILLED, UL94V-2, COLOR: NATURAL
"100" = NYLON (PA66), UNFILLED, UL94V-2, COLOR: BLACK
"BL" = NYLON (PA66), UNFILLED, UL94V-2, COLOR: BLACK
"210" = NYLON (PA66), UNFILLED, UL94V-0, COLOR: NATURAL
"400" = NYLON (PA66), UNFILLED, UL94V-0, COLOR: BLACK

TERMINAL:
BRASS ALLOY

2) FINISH (PLATING):
"BLANK" = .000200/(0.00508) MIN. BRIGHT TIN OVER
.000100/(0.00254) MIN. COPPER
"G" = .000030/(0.00076) MIN. GOLD OVER
.000050/(0.00127) MIN. NICKEL
"G2" = .000015/(0.00038) MIN. GOLD OVER
.000030/(0.00076) MIN. NICKEL
"G3" = .000050/(0.00127) MIN. GOLD OVER
.000050/(0.00127) MIN. NICKEL
"*GS" = .000030/(0.00076) MIN. SELECT GOLD OVER
.000100/(0.00254) MIN. SELECT MATTE TIN
OVER .000050/(0.00127) MIN. NICKEL OVERALL
"*GS2" = .000015/(0.00038) MIN. SELECT GOLD OVER
.000100/(0.00254) MIN. SELECT MATTE TIN
OVER .000050/(0.00127) MIN. NICKEL OVERALL
"*GS3" = .000050/(0.00127) MIN. SELECT GOLD OVER
.000100/(0.00254) MIN. SELECT MATTE TIN
OVER .000050/(0.00127) MIN. NICKEL OVERALL
"S" = .000100/(0.00254) MIN. BRIGHT TIN OVER
.000050/(0.00127) MIN. NICKEL

*THE PRIMARY SHIPPING CARTON WILL BE LABELED "COMPLIANT TO
RoHS DIRECTIVE 2002/95/EC AND ELV ANNEX II OF DIRECTIVE
2000/53/EC", CARTONS WITHOUT THIS LABEL MAY CONTAIN
PRODUCT WITH TIN-LEAD PLATING.

3) PRODUCT SPECIFICATION: SHOWN IN CHART AT RIGHT

4) PACKAGING:
"BLANK" = BULK PACKED PER PK-5569-002
"T" = TRAY PACKED PER PK-5569-003

5) PART MATES WITH MINI-FIT JR. RECEPTACLE SERIES 5557.

6) MOUNTING OPTIONS:
1 = SCREW MOUNT (SEE SD-5569-NA* SERIES DRAWING)
2 = PEG MOUNT

7) DISCOLORATION IN THE BANDOLIER CARRIER AREA OF THE PIN IS
INHERENT TO THE PLATING PROCESS AND IS DUE TO THE MASKING
EFFECT OF THE CARRIER. THIS DISCOLORATION IS IN A NON-FUNCTIONAL
AREA OF THE PIN AND WILL NOT AFFECT THE PERFORMANCE OF THE
HEADER ASSEMBLY.

8) PART CONFORMS TO CLASS "B" REQUIREMENTS OF COSMETIC
SPECIFICATION PS-45499-002.

9) CONNECTORS ARE NOT TO BE MATED AND UNMATED WHILE CIRCUITS ARE LIVE.

10) PARTS ARE NOT DESIGNED FOR CURRENT SHARING.

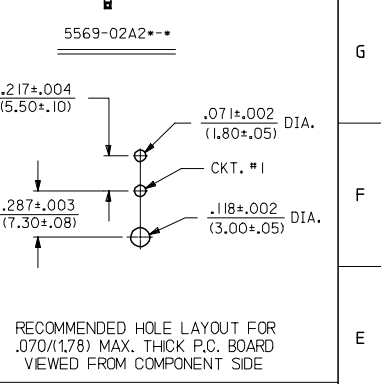
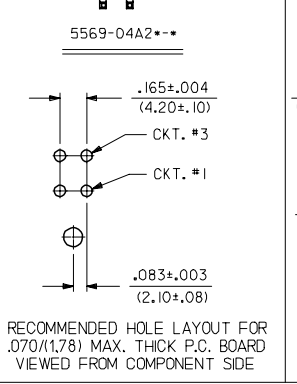
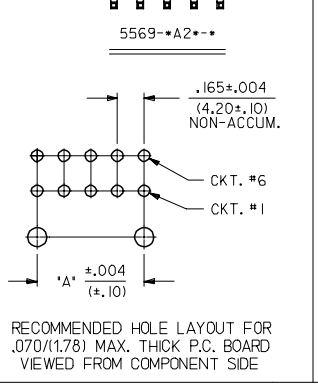

ADD RIB TO SIDE VIEW
EC NO: UCP2007-2432
DR: WALSCHMIDT 2007/05/03
CHKD: ADERR 2007/05/04
APPR: FSMITH 2007/05/07

QUALITY SYMBOLS
▽=0
▽=0

GENERAL TOLERANCES (UNLESS SPECIFIED)

	mm	INCH
4 PLACES ± ---	± .10	± .004
3 PLACES ± ---	± .015	± .001
2 PLACES ± .25	± .010	± .0004
1 PLACE ± .38	± .005	± .0002
ANGULAR ±1/2°		

DRAFT WHERE APPLICABLE
MUST REMAIN
WITHIN DIMENSIONS

MATERIAL NO. SEE CHART
DOCUMENT NO. SDA-5569-NA2*-*

SHEET NO. 1 OF 6

2-6	GENERAL DOCS.	L			
1	MEIO	L			
SHT.	SOFTWARE	REV.			
ENG. NO.			PROD. SPEC. NO.		
PRODUCT SPEC. CHART					
SCALE 4:1			DESIGN UNITS METRIC		
DRAWN BY R/JF			DATE 1988/02/16		
CHECKED BY GT			DATE 1988/02/16		
APPROVED BY RAS			DATE 1988/02/16		
THIRD ANGLE PROJECTION					
MINI-FIT JR RIGHT ANGLE HEADER ASSEMBLIES WITH MOUNTING PEGS					
MOLEX INCORPORATED					

BULK PACKAGED PER PK-5569-002

PART NUMBER	ENG. NUMBER	CKT. SIZE	PLATING (NOTE 2)	HSG MAT'L	PART NUMBER	ENG. NUMBER	CKT. SIZE	PLATING (NOTE 2)	HSG MAT'L
39-30-1020	5569-02A2	2			39-30-0020	5569-02A2-210	2		
39-30-1040	5569-04A2	4			39-30-0040	5569-04A2-210	4		
39-30-1060	5569-06A2	6			39-30-0060	5569-06A2-210	6		
39-30-1080	5569-08A2	8	TIN OVER COPPER		39-30-0080	5569-08A2-210	8	TIN OVER COPPER	
39-30-1100	5569-10A2	10	SEE NOTE 2	94V-2	39-30-0100	5569-10A2-210	10	SEE NOTE 2	94V-0
39-30-1120	5569-12A2	12	NOTE 2		39-30-0120	5569-12A2-210	12	NOTE 2	
39-30-1140	5569-14A2	14	OPTION		39-30-0140	5569-14A2-210	14	OPTION	
39-30-1160	5569-16A2	16	"BLANK"		39-30-0160	5569-16A2-210	16	"BLANK"	
39-30-1180	5569-18A2	18			39-30-0180	5569-18A2-210	18		
39-30-1200	5569-20A2	20			39-30-0200	5569-20A2-210	20		
39-30-1220	5569-22A2	22			39-30-0220	5569-22A2-210	22		
39-30-1240	5569-24A2	24			39-30-0240	5569-24A2-210	24		

39-30-1021	5569-02A2G	2			39-30-1022	5569-02A2G-210	2		
39-30-1041	5569-04A2G	4			39-30-1042	5569-04A2G-210	4		
39-30-1061	5569-06A2G	6			39-30-1062	5569-06A2G-210	6		
39-30-1081	5569-08A2G	8	30 μ" GOLD		39-30-1082	5569-08A2G-210	8	30 μ" GOLD	
39-30-1101	5569-10A2G	10	SEE NOTE 2	94V-2	39-30-1102	5569-10A2G-210	10	SEE NOTE 2	94V-0
39-30-1121	5569-12A2G	12	OPTION		39-30-1122	5569-12A2G-210	12	OPTION	
39-30-1141	5569-14A2G	14			39-30-1142	5569-14A2G-210	14		
39-30-1161	5569-16A2G	16	"G"		39-30-1162	5569-16A2G-210	16	"G"	
39-30-1181	5569-18A2G	18			39-30-1182	5569-18A2G-210	18		
39-30-1201	5569-20A2G	20			39-30-1202	5569-20A2G-210	20		
39-30-1221	5569-22A2G	22			39-30-1222	5569-22A2G-210	22		
39-30-1241	5569-24A2G	24			39-30-1242	5569-24A2G-210	24		

39-30-0021	5569-02A2G2	2			39-30-0022	5569-02A2G2-210	2		
39-30-0041	5569-04A2G2	4			39-30-0042	5569-04A2G2-210	4		
39-30-0061	5569-06A2G2	6			39-30-0062	5569-06A2G2-210	6		
39-30-0081	5569-08A2G2	8	15 μ" GOLD		39-30-0082	5569-08A2G2-210	8	15 μ" GOLD	
39-30-0101	5569-10A2G2	10	SEE NOTE 2	94V-2	39-30-0102	5569-10A2G2-210	10	SEE NOTE 2	94V-0
39-30-0121	5569-12A2G2	12	OPTION		39-30-0122	5569-12A2G2-210	12	OPTION	
39-30-0141	5569-14A2G2	14	"G2"		39-30-0142	5569-14A2G2-210	14	"G2"	
39-30-0161	5569-16A2G2	16			39-30-0162	5569-16A2G2-210	16		
39-30-0181	5569-18A2G2	18			39-30-0182	5569-18A2G2-210	18		
39-30-0201	5569-20A2G2	20			39-30-0202	5569-20A2G2-210	20		
39-30-0221	5569-22A2G2	22			39-30-0222	5569-22A2G2-210	22		
39-30-0241	5569-24A2G2	24			39-30-0242	5569-24A2G2-210	24		

NOT TOOLED	5569-02A2G3	2			NOT TOOLED	5569-02A2G3-210	2		
15-27-1514	5569-04A2G3	4			NOT TOOLED	5569-04A2G3-210	4		
15-27-1511	5569-06A2G3	6			NOT TOOLED	5569-06A2G3-210	6		
15-27-1512	5569-08A2G3	8	50 μ" GOLD		NOT TOOLED	5569-08A2G3-210	8	50 μ" GOLD	
15-27-1503	5569-10A2G3	10	SEE NOTE 2	94V-2	15-27-1504	5569-10A2G3-210	10	SEE NOTE 2	94V-0
NOT TOOLED	5569-12A2G3	12	OPTION		NOT TOOLED	5569-12A2G3-210	12	OPTION	
NOT TOOLED	5569-14A2G3	14	"G3"		NOT TOOLED	5569-14A2G3-210	14	"G3"	
15-27-1513	5569-16A2G3	16			NOT TOOLED	5569-16A2G3-210	16		
NOT TOOLED	5569-18A2G3	18			NOT TOOLED	5569-18A2G3-210	18		
NOT TOOLED	5569-20A2G3	20			NOT TOOLED	5569-20A2G3-210	20		
NOT TOOLED	5569-22A2G3	22			NOT TOOLED	5569-22A2G3-210	22		
NOT TOOLED	5569-24A2G3	24			NOT TOOLED	5569-24A2G3-210	24		

REVISION: ECR/ECN INFORMATION:

TITLE:

SHEET No.

L

EC No: UCP2007-2432

**MINI-FIT JR.® RIGHT ANGLE
HEADER ASSEMBLIES
WITH MOUNTING PEGS**

- 2 -

DATE: 2007/04/02

DOCUMENT NUMBER:

Drawn By:

Checked By:

Approved By:

SDA-5569-NA2*-*

LSCHMIDT

ADERR

FSMITH

BULK PACKAGED PK-5569-002

PART NUMBER	ENG. NUMBER	CKT. SIZE	PLATING (NOTE 2)	HSG MAT'L	PART NUMBER	ENG. NUMBER	CKT. SIZE	PLATING (NOTE 2)	HSG MAT'L
39-30-0023	5569-02A2GS	2	30 μ" SELECT	94V-2	39-30-0024	5569-02A2GS-210	2	30 μ" SELECT	94V-0
39-30-0043	5569-04A2GS	4			39-30-0044	5569-04A2GS-210	4		
39-30-0063	5569-06A2GS	6			39-30-0064	5569-06A2GS-210	6		
39-30-0083	5569-08A2GS	8			39-30-0084	5569-08A2GS-210	8		
39-30-0103	5569-10A2GS	10			39-30-0104	5569-10A2GS-210	10		
39-30-0123	5569-12A2GS	12			39-30-0124	5569-12A2GS-210	12		
39-30-0143	5569-14A2GS	14	NOTE 2 OPTION "GS"	94V-0	39-30-0144	5569-14A2GS-210	14	NOTE 2 OPTION "GS"	94V-0
39-30-0163	5569-16A2GS	16			39-30-0164	5569-16A2GS-210	16		
39-30-0183	5569-18A2GS	18			39-30-0184	5569-18A2GS-210	18		
39-30-0203	5569-20A2GS	20			39-30-0204	5569-20A2GS-210	20		
39-30-0223	5569-22A2GS	22			39-30-0224	5569-22A2GS-210	22		
39-30-0243	5569-24A2GS	24			39-30-0244	5569-24A2GS-210	24		

39-30-1023	5569-02A2GS2	2	15 μ" SELECT	94V-2	39-30-1024	5569-02A2GS2-210	2	15 μ" SELECT	94V-0
39-30-1043	5569-04A2GS2	4			39-30-1044	5569-04A2GS2-210	4		
39-30-1063	5569-06A2GS2	6			39-30-1064	5569-06A2GS2-210	6		
39-30-1083	5569-08A2GS2	8			39-30-1084	5569-08A2GS2-210	8		
39-30-1103	5569-10A2GS2	10			39-30-1104	5569-10A2GS2-210	10		
39-30-1123	5569-12A2GS2	12			39-30-1124	5569-12A2GS2-210	12		
39-30-1143	5569-14A2GS2	14	NOTE 2 OPTION "GS2"	94V-0	39-30-1144	5569-14A2GS2-210	14	NOTE 2 OPTION "GS2"	94V-0
39-30-1163	5569-16A2GS2	16			39-30-1164	5569-16A2GS2-210	16		
39-30-1183	5569-18A2GS2	18			39-30-1184	5569-18A2GS2-210	18		
39-30-1203	5569-20A2GS2	20			39-30-1204	5569-20A2GS2-210	20		
39-30-1223	5569-22A2GS2	22			39-30-1224	5569-22A2GS2-210	22		
39-30-1243	5569-24A2GS2	24			39-30-1244	5569-24A2GS2-210	24		

39-34-4026	5569-02A2GS3	2	50 μ" SELECT	94V-2	39-34-4027	5569-02A2GS3-210	2	50 μ" SELECT	94V-2
39-34-4046	5569-04A2GS3	4			39-34-4047	5569-04A2GS3-210	4		
NOT TOOLED	5569-06A2GS3	6			NOT TOOLED	5569-06A2GS3-210	6		
NOT TOOLED	5569-08A2GS3	8			NOT TOOLED	5569-08A2GS3-210	8		
NOT TOOLED	5569-10A2GS3	10			NOT TOOLED	5569-10A2GS3-210	10		
NOT TOOLED	5569-12A2GS3	12			NOT TOOLED	5569-12A2GS3-210	12		
NOT TOOLED	5569-14A2GS3	14	NOTE 2 OPTION "GS3"	94V-2	NOT TOOLED	5569-14A2GS3-210	14	NOTE 2 OPTION "GS3"	94V-2
NOT TOOLED	5569-16A2GS3	16			NOT TOOLED	5569-16A2GS3-210	16		
NOT TOOLED	5569-18A2GS3	18			NOT TOOLED	5569-18A2GS3-210	18		
NOT TOOLED	5569-20A2GS3	20			NOT TOOLED	5569-20A2GS3-210	20		
NOT TOOLED	5569-22A2GS3	22			NOT TOOLED	5569-22A2GS3-210	22		
NOT TOOLED	5569-24A2GS3	24			NOT TOOLED	5569-24A2GS3-210	24		

39-30-7025	5569-02A2S	2	TIN OVER NICKEL SEE NOTE 2 OPTION "S"	94V-2	39-30-7026	5569-02A2S-210	2	TIN OVER NICKEL SEE NOTE 2 OPTION "S"	94V-0
39-30-7045	5569-04A2S	4			39-30-7046	5569-04A2S-210	4		
39-30-7065	5569-06A2S	6			39-30-7066	5569-06A2S-210	6		
39-30-7085	5569-08A2S	8			39-30-7086	5569-08A2S-210	8		
39-30-7105	5569-10A2S	10			39-30-7106	5569-10A2S-210	10		
39-30-7125	5569-12A2S	12			39-30-7126	5569-12A2S-210	12		
39-30-7145	5569-14A2S	14	94V-0	39-30-7146	5569-14A2S-210	14	94V-0		
39-30-7165	5569-16A2S	16		39-30-7166	5569-16A2S-210	16			
39-30-7185	5569-18A2S	18		39-30-7186	5569-18A2S-210	18			
39-30-7205	5569-20A2S	20		39-30-7206	5569-20A2S-210	20			
39-30-7225	5569-22A2S	22		39-30-7226	5569-22A2S-210	22			
39-30-7245	5569-24A2S	24		39-30-7246	5569-24A2S-210	24			

REVISION:	ECR/ECN INFORMATION:	TITLE:	SHEET No.
L	DATE: 2007/04/02	MINI-FIT JR.® RIGHT ANGLE HEADER ASSEMBLIES WITH MOUNTING PEGS	- 3 -

DOCUMENT NUMBER: SDA-5569-NA2*-*	Drawn By: LSCHMIDT	Checked By: ADERR	Approved By: FSMITH
--	------------------------------	-----------------------------	-------------------------------

BULK PACKAGED PER PK-5569-002

PART NUMBER	ENG. NUMBER	CKT. SIZE	PLATING (NOTE 2)	HSG MAT'L	PART NUMBER	ENG. NUMBER	CKT. SIZE	PLATING (NOTE 2)	HSG MAT'L
39-34-9022	5569-02A2-100	2			39-31-1021	5569-02A2-BL	2		
39-34-9042	5569-04A2-100	4			39-31-1041	5569-04A2-BL	4		
39-34-9064	5569-06A2-100	6			39-31-1061	5569-06A2-BL	6		
39-34-9084	5569-08A2-100	8	TIN OVER COPPER		39-31-1081	5569-08A2-BL	8	TIN OVER COPPER	
39-34-9104	5569-10A2-100	10			39-31-1101	5569-10A2-BL	10		
39-34-9124	5569-12A2-100	12	SEE NOTE 2	94V-2	39-31-1121	5569-12A2-BL	12	SEE NOTE 2	94V-2
39-34-9144	5569-14A2-100	14	OPTION "BLANK"		39-31-1141	5569-14A2-BL	14	OPTION "BLANK"	
39-34-9164	5569-16A2-100	16			39-31-1161	5569-16A2-BL	16		
39-34-9184	5569-18A2-100	18			39-31-1181	5569-18A2-BL	18		
39-34-9204	5569-20A2-100	20			39-31-1201	5569-20A2-BL	20		
39-34-9224	5569-22A2-100	22			39-31-1221	5569-22A2-BL	22		
39-34-9244	5569-24A2-100	24			39-31-1241	5569-24A2-BL	24		

39-34-9023	5569-02A2S-100	2			39-31-6029	5569-02A2G-BL	2		
39-34-9043	5569-04A2S-100	4			39-31-6049	5569-04A2G-BL	4		
39-34-9063	5569-06A2S-100	6			39-31-6069	5569-06A2G-BL	6		
39-34-9083	5569-08A2S-100	8	TIN OVER NICKEL		39-31-6089	5569-08A2G-BL	8	30 μ"	
39-34-9103	5569-10A2S-100	10			39-31-6109	5569-10A2G-BL	10	GOLD	
39-34-9123	5569-12A2S-100	12	SEE NOTE 2	94V-2	39-31-6129	5569-12A2G-BL	12	SEE NOTE 2	94V-2
39-34-9143	5569-14A2S-100	14	OPTION "S"		39-31-6149	5569-14A2G-BL	14	OPTION "G"	
39-34-9163	5569-16A2S-100	16			39-31-6169	5569-16A2G-BL	16		
39-34-9183	5569-18A2S-100	18			39-31-6189	5569-18A2G-BL	18		
39-34-9203	5569-20A2S-100	20			39-31-6209	5569-20A2G-BL	20		
39-34-9223	5569-22A2S-100	22			39-31-6229	5569-22A2G-BL	22		
39-34-9243	5569-24A2S-100	24			39-31-6249	5569-24A2G-BL	24		

39-34-9020	5569-02A2-400	2			39-31-7020	5569-02A2G2-BL	2		
39-34-9040	5569-04A2-400	4			39-31-7040	5569-04A2G2-BL	4		
39-34-9060	5569-06A2-400	6			39-31-7060	5569-06A2G2-BL	6		
39-34-9080	5569-08A2-400	8	TIN OVER COPPER		39-31-7080	5569-08A2G2-BL	8	15 μ"	
39-34-9100	5569-10A2-400	10			39-31-7100	5569-10A2G2-BL	10	GOLD	
39-34-9120	5569-12A2-400	12	SEE NOTE 2	94V-2	39-31-7120	5569-12A2G2-BL	12	SEE NOTE 2	94V-2
39-34-9140	5569-14A2-400	14	OPTION "BLANK"		39-31-7140	5569-14A2G2-BL	14	OPTION "G2"	
39-34-9160	5569-16A2-400	16			39-31-7160	5569-16A2G2-BL	16		
39-34-9180	5569-18A2-400	18			39-31-7180	5569-18A2G2-BL	18		
39-34-9200	5569-20A2-400	20			39-31-7200	5569-20A2G2-BL	20		
39-34-9220	5569-22A2-400	22			39-31-7220	5569-22A2G2-BL	22		
39-34-9240	5569-24A2-400	24			39-31-7240	5569-24A2G2-BL	24		

39-34-9021	5569-02A2S-400	2			39-31-7021	5569-02A2G3-BL	2		
39-34-9041	5569-04A2S-400	4			39-31-7041	5569-04A2G3-BL	4		
39-34-9061	5569-06A2S-400	6			39-31-7061	5569-06A2G3-BL	6		
39-34-9081	5569-08A2S-400	8	TIN OVER NICKEL		39-31-7081	5569-08A2G3-BL	8	50 μ"	
39-34-9101	5569-10A2S-400	10			39-31-7101	5569-10A2G3-BL	10	GOLD	
39-34-9121	5569-12A2S-400	12	SEE NOTE 2	94V-2	39-31-7121	5569-12A2G3-BL	12	SEE NOTE 2	94V-2
39-34-9141	5569-14A2S-400	14	OPTION "S"		39-31-7141	5569-14A2G3-BL	14	OPTION "G3"	
39-34-9161	5569-16A2S-400	16			39-31-7161	5569-16A2G3-BL	16		
39-34-9181	5569-18A2S-400	18			39-31-7181	5569-18A2G3-BL	18		
39-34-9201	5569-20A2S-400	20			39-31-7201	5569-20A2G3-BL	20		
39-34-9221	5569-22A2S-400	22			39-31-7221	5569-22A2G3-BL	22		
39-34-9241	5569-24A2S-400	24			39-31-7241	5569-24A2G3-BL	24		

REVISION:

ECR/ECN INFORMATION:

TITLE:

SHEET No.

L

EC No: **UCP2007-2432**

**MINI-FIT JR.® RIGHT ANGLE
HEADER ASSEMBLIES
WITH MOUNTING PEGGS**

- 4 -

DOCUMENT NUMBER:

SDA-5569-NA2*-*

Drawn By:

LSCHMIDT

Checked By:

ADERR

Approved By:

FSMITH

DATE: **2007/04/02**

TRAY PACKAGED PER PK-5569-003

PART NUMBER	ENG. NUMBER	CKT. SIZE	PLATING (NOTE 2)	HSG MATL	PART NUMBER	ENG. NUMBER	CKT. SIZE	PLATING (NOTE 2)	HSG MATL
50-36-1757	5569-02A2S-T	2			50-36-1758	5569-02A2S-210-T	2		
50-36-1767	5569-04A2S-T	4			50-36-1768	5569-04A2S-210-T	4		
50-36-1777	5569-06A2S-T	6			50-36-1778	5569-06A2S-210-T	6		
50-36-1787	5569-08A2S-T	8			50-36-1788	5569-08A2S-210-T	8		
50-36-1797	5569-10A2S-T	10	TIN OVER NICKEL		50-36-1798	5569-10A2S-210-T	10		
50-36-1807	5569-12A2S-T	12	SEE NICKEL		50-36-1808	5569-12A2S-210-T	12		
50-36-1817	5569-14A2S-T	14	NOTE 2 OPTION "S"	94V-2	50-36-1818	5569-14A2S-210-T	14		
50-36-1827	5569-16A2S-T	16			50-36-1828	5569-16A2S-210-T	16		
50-36-1837	5569-18A2S-T	18			50-36-1838	5569-18A2S-210-T	18		
50-36-1847	5569-20A2S-T	20			50-36-1848	5569-20A2S-210-T	20		
50-36-1857	5569-22A2S-T	22			50-36-1858	5569-22A2S-210-T	22		
50-36-1867	5569-24A2S-T	24			50-36-1868	5569-24A2S-210-T	24		
50-36-1755	5569-02A2GS-T	2			50-36-1756	5569-02A2GS-210-T	2		
50-36-1765	5569-04A2GS-T	4			50-36-1766	5569-04A2GS-210-T	4		
50-36-1775	5569-06A2GS-T	6			50-36-1776	5569-06A2GS-210-T	6		
50-36-1785	5569-08A2GS-T	8	30 μ" SELECT GOLD		50-36-1786	5569-08A2GS-210-T	8	30 μ" SELECT GOLD	
50-36-1795	5569-10A2GS-T	10	SEE NOTE 2 OPTION "GS"	94V-2	50-36-1796	5569-10A2GS-210-T	10	SEE NOTE 2 OPTION "GS"	94V-0
50-36-1805	5569-12A2GS-T	12			50-36-1806	5569-12A2GS-210-T	12		
50-36-1815	5569-14A2GS-T	14			50-36-1816	5569-14A2GS-210-T	14		
50-36-1825	5569-16A2GS-T	16			50-36-1826	5569-16A2GS-210-T	16		
50-36-1835	5569-18A2GS-T	18			50-36-1836	5569-18A2GS-210-T	18		
50-36-1845	5569-20A2GS-T	20			50-36-1846	5569-20A2GS-210-T	20		
50-36-1855	5569-22A2GS-T	22			50-36-1856	5569-22A2GS-210-T	22		
50-36-1865	5569-24A2GS-T	24			50-36-1866	5569-24A2GS-210-T	24		
		2					2		
		4					4		
		6					6		
		8					8		
		10					10		
		12					12		
		14					14		
		16					16		
		18					18		
		20					20		
		22					22		
		24					24		

REVISION: ECR/ECON INFORMATION: TITLE: SHEET No.

EC No: UCP2007-2432

L

DATE: 2007/04/02

**MINI-FIT JR.® RIGHT ANGLE
HEADER ASSEMBLIES
WITH MOUNTING PEGS**

DOCUMENT NUMBER: **SDA-5569-NA2*-*** Drawn By: **LSCHMIDT** Checked By: **ADERR** Approved By: **FSMITH**