

ASSEMBLY ITEM NUMBER	PART CHARACTERISTICS	
	NUMBER OF POSITION	PANEL MOUNT OPTION
43020-0200	02	YES
43020-0201	02	NO
43020-0400	04	YES
43020-0401	04	NO
43020-0600	06	YES
43020-0601	06	NO
43020-0800	08	YES
43020-0801	08	NO
43020-1000	10	YES
43020-1001	10	NO
43020-1200	12	YES
43020-1201	12	NO
43020-1400	14	YES
43020-1401	14	NO
43020-1600	16	YES
43020-1601	16	NO
43020-1800	18	YES
43020-1801	18	NO
43020-2000	20	YES
43020-2001	20	NO
43020-2200	22	YES
43020-2201	22	NO
43020-2400	24	YES
43020-2401	24	NO

CKT. NO.	DIM. "A"	DIM. "B"	DIM. "C"	DIM. "D"
2	.152/(3.86)	N/A	.166/(4.21)	.311/(7.90)
4	.270/(6.85)	.118/(3.00)	.284/(7.21)	.429/(10.90)
6	.388/(9.85)	.236/(6.00)	.402/(10.21)	.547/(13.89)
8	.506/(12.85)	.354/(9.00)	.520/(13.21)	.665/(16.89)
10	.624/(15.85)	.472/(12.00)	.638/(16.21)	.783/(19.89)
12	.742/(18.85)	.591/(15.00)	.756/(19.21)	.901/(22.89)
14	.860/(21.85)	.709/(18.00)	.874/(22.20)	1.019/(25.88)
16	.978/(24.85)	.827/(21.00)	.992/(25.20)	1.137/(28.88)
18	1.096/(27.85)	.945/(24.00)	1.110/(28.20)	1.255/(31.88)
20	1.215/(30.85)	1.063/(27.00)	1.229/(31.22)	1.373/(34.87)
22	1.333/(33.85)	1.181/(30.00)	1.347/(34.22)	1.491/(37.87)
24	1.451/(36.85)	1.299/(33.00)	1.465/(37.22)	1.609/(40.87)

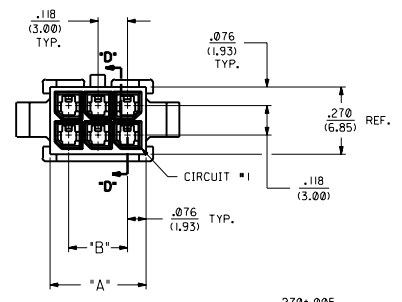

- NOTES:
- 1) HOUSING MATERIAL: UNFILLED POLYESTER (PBT), UL94V-0, COLOR - BLACK.
 - 2) THIS HOUSING MATES WITH MICRO-FIT RECEPTACLE #43025-****.
 - 3) THIS HOUSING IS DESIGNED IN METRIC.
 - 4) THIS HOUSING TO BE USED WITH MOLEX MALE TERMINAL #43031-****.
 - 5) DESIGNED FOR .055/(1.4) MINIMUM TO A .100/(2.54) MAXIMUM THICK PANEL OR PRINTED CIRCUIT BOARDS.
 - 6) SEE SECTION "D"-D" FOR TERMINAL ORIENTATION IN HOUSING.
 - 7) PRODUCT SPECIFICATION : PS-43045
 - 8) PANEL MOUNT FEATURES MUST LOCK ON SIDE OPPOSITE PUNCH SIDE FOR OPTIMUM RETENTION.

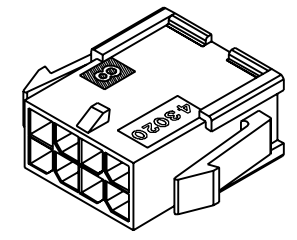

PLUG WITH OPTIONAL PANEL MOUNTS
ISO VIEW
(8 CIRCUIT SHOWN)

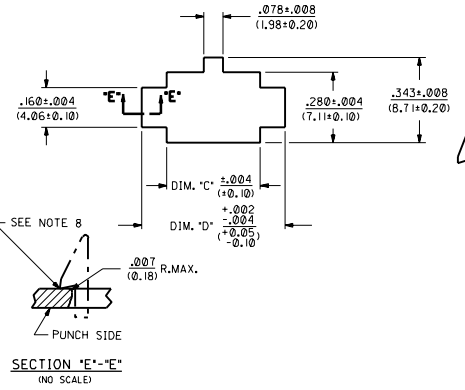

SECTION "E"-E"
(NO SCALE)

RECOMMENDED PANEL CUT-OUT

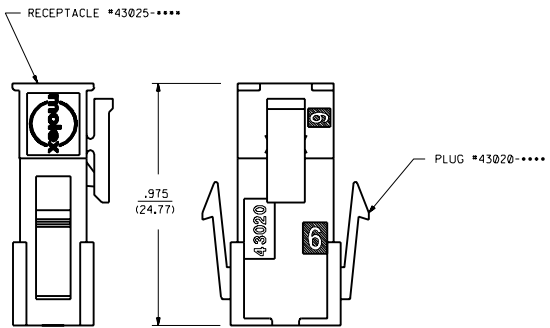

MATED MICRO-FIT CONNECTOR

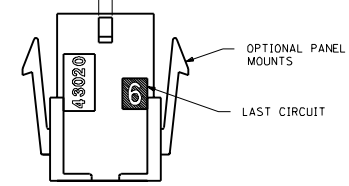
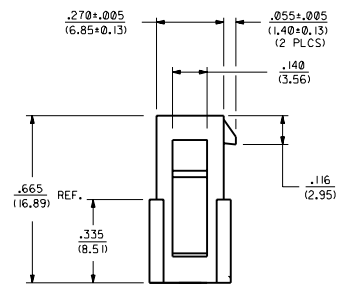
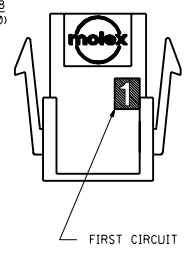

OPTIONAL PANEL MOUNTS
LAST CIRCUIT

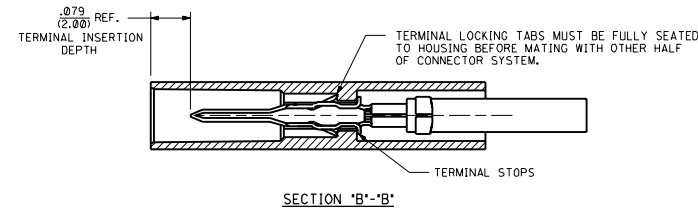

SECTION "B"-B"

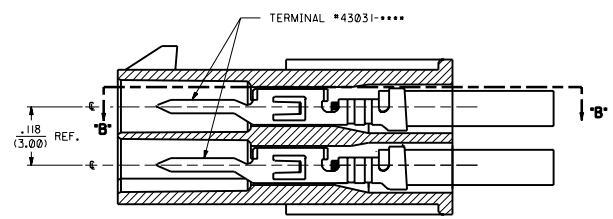

SECTION "D"-D"
WITH TERMINAL
(SCALE: 8X)

MFG. SH. REV. LTR. REVISIONS

REV LATCH HOOKS
UCR2002-0480
01/11/28 MEYLLER

DIMENSIONS SHOWN: METRIC (INCH)

2 PLUG ± 0.10	± 0.10	± 0.25
2 PLUG ± 0.14	± 0.14	± 0.35
1 PLUG ---	---	---

MOLEX INCORPORATED

TITLE: MICRO-FIT (3.0) 2 THRU 24 CIRCUIT PLUG WITH OPTIONAL PANEL MOUNTS

DATE: 1/93/01/07

REV: 1

SEE CHART SDA-43020-****

SCALE: 4:1

CP D