

Distributed by:

JAMECO[®]
ELECTRONICS

www.Jameco.com ♦ 1-800-831-4242

The content and copyrights of the attached
material are the property of its owner.

Jameco Part Number 1970130

3.00mm (.118") Pitch Micro-Fit 3.0™ Wire-to-Board Header

43045
Dual Row
Vertical

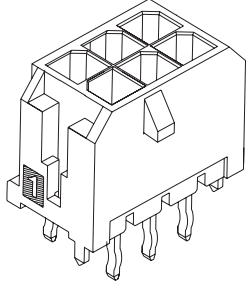

Features and Benefits

- "Offset Terminal Retention" for optimum retention to PC board during wave soldering
- Fully polarized to mating receptacle
- Peg feature provides polarization to PCB
- Surface Mount Compatible

Reference Information

Product Specification: PS-43045
Packaging: Tray
UL File No.: E29179
CSA File No.: LR19980
TUV License No.: R72040445
Mates With: 43025
Designed In: Millimeters

Electrical

Voltage: 250V
Current: 5.0A max.
Contact Resistance: 10 milliohms max.
Dielectric Withstanding Voltage: 1500V AC
Insulation Resistance: 1000 Megohms min.

Mechanical

Insertion Force to PCB: 7.5kgf max. (16.5 lb)

Physical

Housing: High temperature LCP, UL 94V-0
Contact: Brass
Plating: Tin or Gold

Circuits	Order No.						Lead-free
	Standard "OTR" Version			Straight Tail Version			
	Tin	15µ" Gold	30µ" Gold	Tin	15µ" Gold	30µ" Gold	
2	43045-0212	43045-0213	43045-0214	43045-0227	43045-0228	43045-0229	Yes
4	43045-0412	43045-0413	43045-0414	43045-0427	43045-0428	43045-0429	
6	43045-0612	43045-0613	43045-0614	43045-0627	43045-0628	43045-0629	
8	43045-0812	43045-0813	43045-0814	43045-0827	43045-0828	43045-0829	
10	43045-1012	43045-1013	43045-1014	43045-1027	43045-1028	43045-1029	
12	43045-1212	43045-1213	43045-1214	43045-1227	43045-1228	43045-1229	
14	43045-1412	43045-1413	43045-1414	43045-1427	43045-1428	43045-1429	
16	43045-1612	43045-1613	43045-1614	43045-1627	43045-1628	43045-1629	
18	43045-1812	43045-1813	43045-1814	43045-1827	43045-1828	43045-1829	
20	43045-2012	43045-2013	43045-2014	43045-2027	43045-2028	43045-2029	
22	43045-2212	43045-2213	43045-2214	43045-2227	43045-2228	43045-2229	
24	43045-2412	43045-2413	43045-2414	43045-2427	43045-2428	43045-2429	

3.00mm (.118") Micro-Fit 3.0™ Wire-to-Board Header

43045
Dual Row, Vertical, SMT
With Solderable Retention Clip

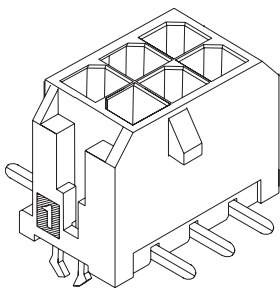

Features and Benefits

- Solderable retention clip provides optimum retention to PCB
- Fully polarized to mating receptacle
- Tape and reel packaging eliminates handling and provides for higher insertion speeds compared to tray packing or hand assembly

Reference Information

Product Specification: PS-43045
Packaging: Tape and reel
UL File No.: E29179
CSA File No.: LR19980
TUV License No.: R72040445
Mates With: 43025
Designed In: Millimeters

Electrical

Voltage: 250V
Current: 5.0A max.
Contact Resistance: 10 milliohms max.
Dielectric Withstanding Voltage: 1500V AC
Insulation Resistance: 1000 Megohms min.

Mechanical

Insertion Force to PCB: 7.5kgf max. (16.5 lb)

Physical

Housing: High temperature LCP, UL 94V-0
Contact: Brass
Plating: Tin or Gold

Circuits	Order No.			Lead-free	Circuits	Order No.			Lead-free
	Tin	15µ" Gold	30µ" Gold			Tin	15µ" Gold	30µ" Gold	
2	43045-0215	43045-0216	43045-0217	Yes	14	43045-1415	43045-1416	43045-1417	Yes
4	43045-0415	43045-0416	43045-0417		16	43045-1615	43045-1616	43045-1617	
6	43045-0615	43045-0616	43045-0617		18	43045-1815	43045-1816	43045-1817	
8	43045-0815	43045-0816	43045-0817		20	43045-2015	43045-2016	43045-2017	
10	43045-1015	43045-1016	43045-1017		22	43045-2215	43045-2216	43045-2217	
12	43045-1215	43045-1216	43045-1217		24	43045-2415	43045-2416	43045-2417	

3.00mm (.118") Pitch Micro-Fit 3.0™ Wire-to-Board Header

43045
Dual Row, Vertical, SMT
With Solderable Fitting Nail

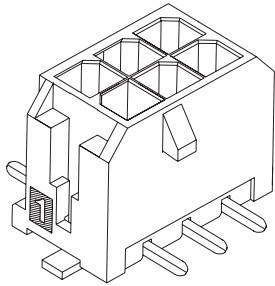

Features and Benefits

- Solder tabs provide retention to PCB
- Fully polarized to mating receptacle
- Tape and reel packaging eliminates handling and provides for higher PCB board placement speeds compared to tray packing or hand assembly

Reference Information

Product Specification: PS-43045
Packaging: Tape and reel
UL File No.: E29179
CSA File No.: LR19980
TUV License No.: R72040445
Mates With: 43025
Designed In: Millimeters

Electrical

Voltage: 250V
Current: 5.0A max.
Contact Resistance: 10 milliohms max.
Dielectric Withstanding Voltage: 1500V AC
Insulation Resistance: 1000 Megohms min.

Physical

Housing: High temperature LCP, UL 94V-0
Contact: Brass
Plating: Tin or Gold

Circuits	Order No.			Lead-free
	Tin	15µ" Gold	30µ" Gold	
2	43045-0218	43045-0219	43045-0220	Yes
4	43045-0418	43045-0419	43045-0420	
6	43045-0618	43045-0619	43045-0620	
8	43045-0818	43045-0819	43045-0820	
10	43045-1018	43045-1019	43045-1020	
12	43045-1218	43045-1219	43045-1220	

Circuits	Order No.			Lead-free
	Tin	15µ" Gold	30µ" Gold	
14	43045-1418	43045-1419	43045-1420	Yes
16	43045-1618	43045-1619	43045-1620	
18	43045-1818	43045-1819	43045-1820	
20	43045-2018	43045-2019	43045-2020	
22	43045-2218	43045-2219	43045-2220	
24	43045-2418	43045-2419	43045-2420	

3.00mm (.118") Pitch Micro-Fit 3.0™ Wire-to-Board Header

43045
Dual Row
Right Angle

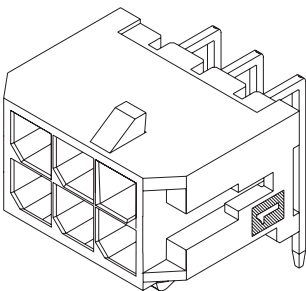

Features and Benefits

- Snap-in peg locks header to PCB for optimum retention
- Fully polarized to mating receptacle
- Surface Mount Compatible

Reference Information

Product Specification: PS-43045
Packaging: Tray
UL File No.: E29179
CSA File No.: LR19980
TUV License No.: R72040445
Mates With: 43025
Designed In: Millimeters

Electrical

Voltage: 250V
Current: 5.0A max.
Contact Resistance: 10 milliohms max.
Dielectric Withstanding Voltage: 1500V AC
Insulation Resistance: 1000 Megohms min.

Mechanical

Insertion Force to PCB: 7.5kgf max. (16.5 lb)

Physical

Housing: High temperature LCP, UL 94V-0
Contact: Brass
Plating: Tin or Gold

Circuits	Order No.			Lead-free
	Tin	15µ" Gold	30µ" Gold	
2	43045-0200	43045-0201	43045-0202	Yes
4	43045-0400	43045-0401	43045-0402	
6	43045-0600	43045-0601	43045-0602	
8	43045-0800	43045-0801	43045-0802	
10	43045-1000	43045-1001	43045-1002	
12	43045-1200	43045-1201	43045-1202	

Circuits	Order No.			Lead-free
	Tin	15µ" Gold	30µ" Gold	
14	43045-1400	43045-1401	43045-1402	Yes
16	43045-1600	43045-1601	43045-1602	
18	43045-1800	43045-1801	43045-1802	
20	43045-2000	43045-2001	43045-2002	
22	43045-2200	43045-2201	43045-2202	
24	43045-2400	43045-2401	43045-2402	

3.00mm (.118") Pitch Micro-Fit 3.0™ Wire-to-Board Header

43045 Dual Row, Right Angle, SMT With Solderable Retention Clip

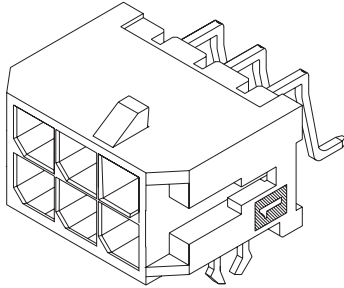

Features and Benefits

- Solderable retention clip provides optimum retention to PCB
- Fully polarized to mating receptacle
- Tape and reel packaging eliminates handling and provides higher insertion speed compared to tray packing or hand assembly

Reference Information

Product Specification: PS-43045
Packaging: Tape and reel
UL File No.: E29179
CSA File No.: LR19980
TUV License No.: R72040445
Mates With: 43025
Designed In: Millimeters

Electrical

Voltage: 250V
Current: 5.0A max.
Contact Resistance: 10 milliohms max.
Dielectric Withstanding Voltage: 1500V AC
Insulation Resistance: 1000 Megohms min.

Mechanical

Insertion Force to PCB: 7.5kgf max. (16.5 lb)

Physical

Housing: High temperature LCP, UL 94V-0
Contact: Brass
Plating: Tin or Gold

Circuits	Order No.			Lead-free
	Tin	15µm Gold	30µm Gold	
2	43045-0206	43045-0207	43045-0208	Yes
4	43045-0406	43045-0407	43045-0408	
6	43045-0606	43045-0607	43045-0608	
8	43045-0806	43045-0807	43045-0808	
10	43045-1006	43045-1007	43045-1008	
12	43045-1206	43045-1207	43045-1208	

Circuits	Order No.			Lead-free
	Tin	15µm Gold	30µm Gold	
14	43045-1406	43045-1407	43045-1408	Yes
16	43045-1606	43045-1607	43045-1608	
18	43045-1806	43045-1807	43045-1808	
20	43045-2006	43045-2007	43045-2008	
22	43045-2206	43045-2207	43045-2208	
24	43045-2406	43045-2407	43045-2408	

3.00mm (.118") Pitch Micro-Fit 3.0™ Wire-to-Board Header

43045 Dual Row, Right Angle, SMT With Solderable Fitting Nail

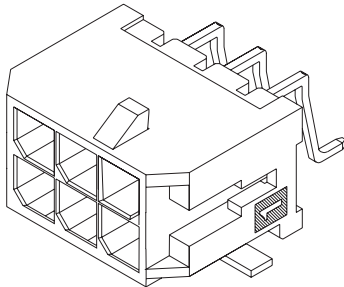

Features and Benefits

- Solder tabs provide retention to PCB
- Fully polarized to mating receptacle
- Tape and reel packaging eliminates handling and provides higher insertion speeds compared to tray packing or hand assembly

Reference Information

Product Specification: PS-43045
Packaging: Tape and reel
UL File No.: E29179
CSA File No.: LR19980
TUV License No.: R72040445
Mates With: 43025
Designed In: Millimeters

Electrical

Voltage: 250V
Current: 5.0A max.
Contact Resistance: 10 milliohms max.
Dielectric Withstanding Voltage: 1500V AC
Insulation Resistance: 1000 Megohms min.

Physical

Housing: High temperature LCP, UL 94V-0
Contact: Brass
Plating: Tin or Gold

Circuits	Order No.			Lead-free
	Tin	15µm Gold	30µm Gold	
2	43045-0209	43045-0210	43045-0211	Yes
4	43045-0409	43045-0410	43045-0411	
6	43045-0609	43045-0610	43045-0611	
8	43045-0809	43045-0810	43045-0811	
10	43045-1009	43045-1010	43045-1011	
12	43045-1209	43045-1210	43045-1211	

Circuits	Order No.			Lead-free
	Tin	15µm Gold	30µm Gold	
14	43045-1409	43045-1410	43045-1411	Yes
16	43045-1609	43045-1610	43045-1611	
18	43045-1809	43045-1810	43045-1811	
20	43045-2009	43045-2010	43045-2011	
22	43045-2209	43045-2210	43045-2211	
24	43045-2409	43045-2410	43045-2411	



PRODUCT SPECIFICATION

MICRO-FIT

1.0 SCOPE

This Product Specification covers the 3.00 mm (.118 inch) centerline (pitch) square pin headers when mated with either printed circuit board (PCB) connector or connectors terminated with 20 to 30 AWG wire using crimp technology.

2.0 PRODUCT DESCRIPTION

2.1 PRODUCT NAME AND SERIES NUMBERS

Receptacle: 43025 Terminal: 43030
Plug: 43020 Terminal: 43031
Headers: 43045, 44914

Test Plug: 44242 (recommended for continuity testing only)

Other products conforming to this specification are noted on the individual drawings.

2.2 DIMENSIONS, MATERIALS, PLATINGS AND MARKINGS

Housings: Polyester or LCP
Terminal: Phosphor Bronze
Pins: Brass, Modified Tin/Brass

2.3 SAFETY AGENCY APPROVALS

UL File Number: E29179 CSA: LR19980 TUV: 72040445

3.0 APPLICABLE DOCUMENTS AND SPECIFICATIONS

Test Summary: TS-43045-001

4.0 RATINGS

4.1 VOLTAGE

UL: 43025, 43045, and 44914 series: 600 Volts AC RMS or DC.

43020 series: 350 Volts AC RMS or DC.

TUV: 250 Volts

4.2 CURRENT AND APPLICABLE WIRES (Current is dependent on connector size, contact material, plating, ambient temperature, printed circuit board characteristics and related factors. Actual current rating is application dependent and should be evaluated for each application.)

AWG	Amps	Max. Outside Insulation Diameter
20	5	1.85 mm (.073 inch)
22	5	1.85 mm (.073 inch)
24	4	1.85 mm (.073 inch)
26	3	1.27 mm (.050 inch)
28	2	1.27 mm (.050 inch)
30	1	1.27 mm (.050 inch)

4.2.1 CURRENT FOR TEST PLUG 44242

2.5 Amps Maximum (Pogo pin current capacity)

(Test plugs are for testing purposes only and not intended for continuous use.)

4.3 TEMPERATURE

Operating: - 40°C to + 105°C (Including Terminal Temperature Rise)

Non-operating: - 40°C to + 105°C

REVISION: M3	ECR/ECN INFORMATION: EC No: UCP2009-0508 DATE: 2008/08/26	TITLE: PRODUCT SPECIFICATION MICRO-FIT DUAL ROW CONNECTORS	SHEET No. 1 of 7
DOCUMENT NUMBER: PS-43045	CREATED / REVISED BY: GAVERILL	CHECKED BY: SSOUSEK	APPROVED BY: FSMITH



PRODUCT SPECIFICATION

5.0 PERFORMANCE

5.1 ELECTRICAL REQUIREMENTS

DESCRIPTION	TEST CONDITION	REQUIREMENT
Contact Resistance (Low Level)	Mate connectors: apply a maximum voltage of 20 mV and a current of 100 mA. (Does not include wire resistance)	10 milliohms MAXIMUM [initial]
Contact Resistance @ Rated Current	Mate connectors: apply a maximum voltage of 20 mV at rated current.	30 milliohms MAXIMUM [initial]
Contact Resistance of Wire Termination (Low Level)	Terminate the applicable wire to the terminal and measure wire using a voltage of 20 mV and a current of 100 mA.	5 milliohms MAXIMUM [initial]
Insulation Resistance	Unmate & unmount connectors: apply a voltage of 500 VDC between adjacent terminals and between terminals to ground.	1000 Megohms MINIMUM
Dielectric Withstanding Voltage	Unmate connectors: apply a voltage of {two times the rated voltage plus 1000 volts} VAC for 1 minute between adjacent terminals and between terminals to ground.	No breakdown; current leakage < 5 mA
Capacitance	Measure between adjacent terminals at 1 MHz.	2 picofarads MAXIMUM
Temperature Rise (via Current Cycling)	Mate connectors: measure the temperature rise at the rated current after: 1) 96 hours (steady state) 2) 240 hours (45 minutes ON and 15 minutes OFF per hour) 3) 96 hours (steady state)	Temperature rise: +30°C MAXIMUM

5.2 MECHANICAL REQUIREMENTS

DESCRIPTION	TEST CONDITION	REQUIREMENT
Connector Mate and Unmate Forces	Mate and unmate connector (male to female) at a rate of 25 ± 6 mm (1 ± ¼ inch) per minute. (Per circuit)	8.0 N (1.8 lbf) MAXIMUM insertion force & 3.7 N (0.8 lbf) MINIMUM withdrawal force
Terminal Retention Force (in Housing)	Axial pullout force on the terminal in the housing at a rate of 25 ± 6 mm (1 ± ¼ inch) per minute.	24.5 N (5.5 lbf) MINIMUM retention force
Terminal Insertion Force (into Housing)	Apply an axial insertion force on the terminal at a rate of 25 ± 6 mm (1 ± ¼ inch) per minute.	14.7 N (3.3 lbf) MAXIMUM insertion force

REVISION: M3	ECR/ECN INFORMATION: EC No: UCP2009-0508 DATE: 2008/08/26	TITLE: PRODUCT SPECIFICATION MICRO-FIT DUAL ROW CONNECTORS	SHEET No. 2 of 7
DOCUMENT NUMBER: PS-43045	CREATED / REVISED BY: GAVERRILL	CHECKED BY: SSOUSEK	APPROVED BY: FSMITH



PRODUCT SPECIFICATION

5.2 MECHANICAL REQUIREMENTS

Durability	Mate connectors up to 30 cycles at a maximum rate of 10 cycles per minute prior to Environmental Tests.	20 milliohms MAXIMUM (change from initial)
Vibration (Random)	Mate connectors and vibrate per EIA 364-28, test condition VII, Letter D. Test Duration: 15 minutes each axis.	20 milliohms MAXIMUM (change from initial) & Discontinuity < 1 microsecond
Shock (Mechanical)	Mate connectors and shock at 50 g's with ½ sine wave (11 milliseconds) shocks in the ±X,±Y,±Z axes (18 shocks total).	20 milliohms MAXIMUM (change from initial)] & Discontinuity < 1 microsecond
Wire Pullout Force (Axial) (Wire from Terminal)	Apply an axial pullout force on the wire at a rate of 25 ± 6 mm (1 ± ¼ inch) per minute.	MINIMUM pullout force 20 awg: 57.8 N (13.0 lbf) 22 awg: 35.6 N (8.0 lbf) 24 awg: 22.2 N (5.0 lbf) 26 awg: 13.3 N (3.0 lbf) 28 awg: 8.9 N (2.0 lbf) 30 awg: 6.6 N (1.5 lbf)
Normal Force	Apply a perpendicular force.	2.7 N (0.6 lbf) MINIMUM
Pin to Header Retention	Apply axial push force to pin at a rate of 25 ± 6 mm (1 ± ¼ inch) per minute.	13.7 N (3.1 lbf) MINIMUM pushout force
Thumb Latch to Ramp Yield Strength	Full mate and then Unmate the connectors at a rate of 25 ± 6 mm (1 ± ¼ inch) per minute.	68.4 N (15.4 lbf) MINIMUM Yield Strength
Panel Mount Retention	Full mate and then Unmate the connectors at a rate of 25 ± 6 mm (1 ± ¼ inch) per minute.	155.7 N (35 lbf) MINIMUM pushout force
Compliant Pin Insertion Force into PCB Hole (44914 Series)	Apply an axial insertion force on the terminal at a rate of 25 ± 6 mm (1 ± ¼ inch) per minute.	106.7 N (24 lbf) MAXIMUM Insertion force (Per Terminal)
Compliant Pin Retention Force in PCB Hole (44914 Series)	Apply an axial extraction force on the terminal at a rate of 25 ± 6 mm (1 ± ¼ inch) per minute.	35.6 N (8 lbf) MINIMUM Retention force (Per Terminal)

REVISION: M3	ECR/ECN INFORMATION: EC No: UCP2009-0508 DATE: 2008/08/26	TITLE: PRODUCT SPECIFICATION MICRO-FIT DUAL ROW CONNECTORS	SHEET No. 3 of 7
DOCUMENT NUMBER: PS-43045	CREATED / REVISED BY: GAVERILL	CHECKED BY: SSOUSEK	APPROVED BY: FSMITH



PRODUCT SPECIFICATION

5.3 ENVIRONMENTAL REQUIREMENTS

DESCRIPTION	TEST CONDITION	REQUIREMENT
Thermal Aging	Mate connectors; expose to: 240 hours at 105 ± 2°C OR 500 hours at 85 ± 2°C	20 milliohms MAXIMUM (change from initial)]
Humidity (Steady State)	Mate connectors: expose to a temperature of 40 ± 2°C with a relative humidity of 90-95% for 96 hours. Note: Remove surface moisture and air dry for 1 hour prior to measurements.	20 milliohms MAXIMUM (change from initial) & Dielectric Withstanding Voltage: No Breakdown at 500 VAC & Insulation Resistance: 1000 Megohms MINIMUM
Solderability	Per SMES-152	Solder coverage: 95% MINIMUM (per SMES-152)
Solder Resistance	A) Wave Solder Process Dip connector terminal tails in solder; Solder Duration: 10 seconds MAX Solder Temperature: 260°C MAX Per ES-40000-5013 B) Convection Reflow Solder Process 235°C MAX Per ES-40000-5013 Parts identified with a green dot on the primary shipping carton label and all parts with a manufacturing date after 11/1/2007: 260°C MAX Per ES-40000-5013	Visual: No Damage to insulator material
Cold Resistance	Mate connectors: Duration: 96 hours; Temperature: -40 ± 3°C	20 milliohms MAXIMUM (change from initial)

6.0 PACKAGING

Parts shall be packaged to protect against damage during handling, transit and storage per the packaging specifications listed below:

Receptacle and Plug: Bulk Packaged

Headers: PK-70873-0313, PK-70873-0314, PK-70873-05**.

REVISION: M3	ECR/ECN INFORMATION: EC No: UCP2009-0508 DATE: 2008/08/26	TITLE: PRODUCT SPECIFICATION MICRO-FIT DUAL ROW CONNECTORS	SHEET No. 4 of 7
DOCUMENT NUMBER: PS-43045	CREATED / REVISED BY: GAVERRILL	CHECKED BY: SSOUSEK	APPROVED BY: FSMITH



PRODUCT SPECIFICATION

7.0 GAGES AND FIXTURES

It is recommended that test plugs (Series 44242) be used for continuity testing of receptacles. Standard mating parts should not be used for harness testing.

8.0 OTHER INFORMATION

8.1 CABLE TIE AND OR WIRE TWIST LOCATION

CKT Sizes	Dim T	Min.
2-8	.500	(12.70)
10-16	.750	(19.10)
18-24	1.000	(25.40)

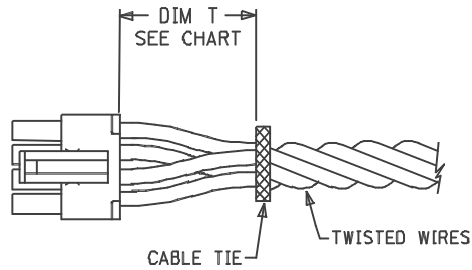

REVISION: M3	ECR/ECN INFORMATION: EC No: UCP2009-0508 DATE: 2008/08/26	TITLE: PRODUCT SPECIFICATION MICRO-FIT DUAL ROW CONNECTORS	SHEET No. 5 of 7
DOCUMENT NUMBER: PS-43045	CREATED / REVISED BY: GAVERILL	CHECKED BY: SSOUSEK	APPROVED BY: FSMITH



PRODUCT SPECIFICATION

8.2 STANDARD POLARIZATION FOR HEADERS AND PLUGS (HEADERS ARE SHOWN)

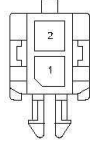

2-CKT.

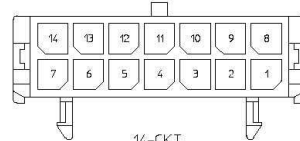

14-CKT.

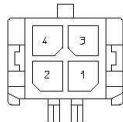

4-CKT.

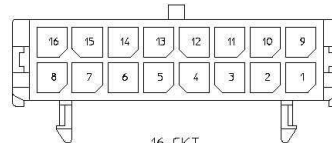

16-CKT.

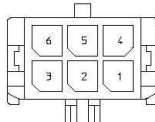

6-CKT.

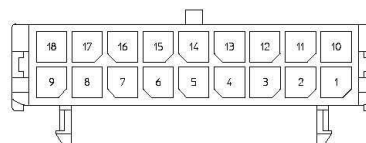

18-CKT.

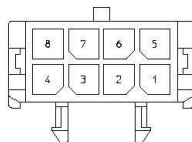

8-CKT.

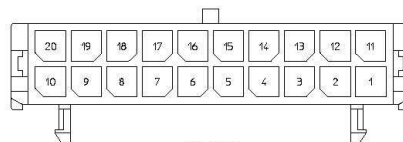

20-CKT.

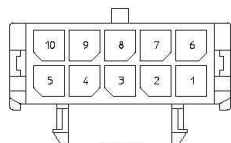

10-CKT.

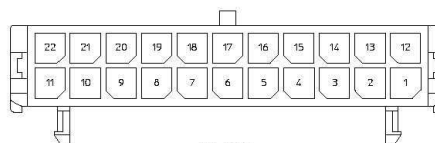

22-CKT.

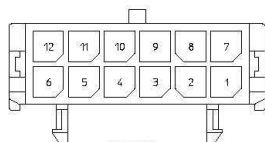

12-CKT.

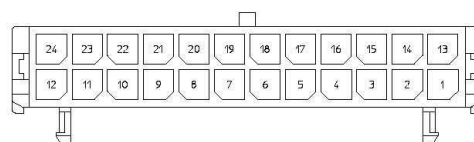

24-CKT.

REVISION: M3	ECR/ECN INFORMATION: EC No: UCP2009-0508 DATE: 2008/08/26	TITLE: PRODUCT SPECIFICATION MICRO-FIT DUAL ROW CONNECTORS	SHEET No. 6 of 7
DOCUMENT NUMBER: PS-43045	CREATED / REVISED BY: GAVERILL	CHECKED BY: SSOUSEK	APPROVED BY: FSMITH



PRODUCT SPECIFICATION

8.3 STANDARD POLARIZATION FOR RECEPTACLES

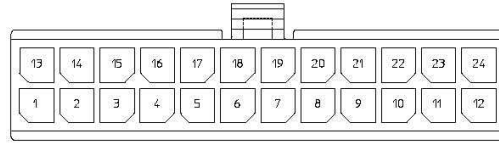

24-CKT.

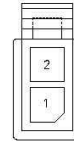

2-CKT.

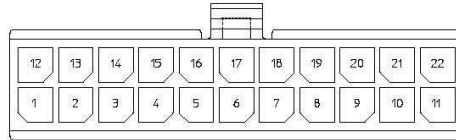

22-CKT.

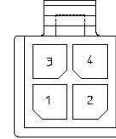

4-CKT.

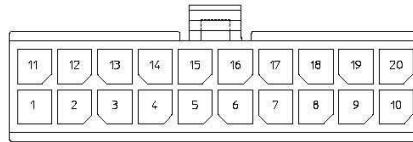

20-CKT.

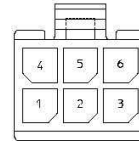

6-CKT.

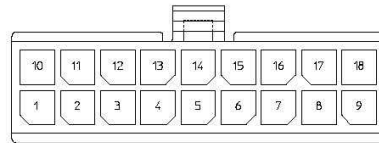

18-CKT.

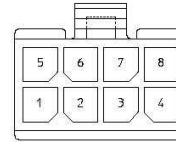

8-CKT.

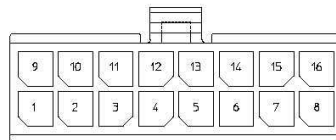

16-CKT.

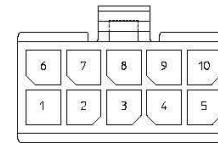

10-CKT.

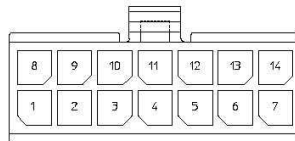

14-CKT.

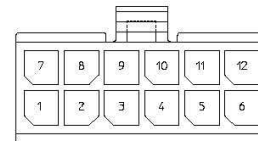

12-CKT.

REVISION: M3	ECR/ECN INFORMATION: EC No: UCP2009-0508 DATE: 2008/08/26	TITLE: PRODUCT SPECIFICATION MICRO-FIT DUAL ROW CONNECTORS	SHEET No. 7 of 7
DOCUMENT NUMBER: PS-43045	CREATED / REVISED BY: GAVERILL	CHECKED BY: SSOUSEK	APPROVED BY: FSMITH

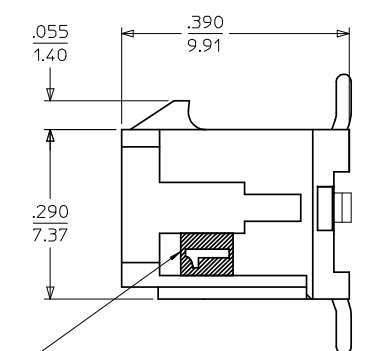
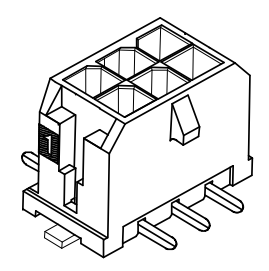
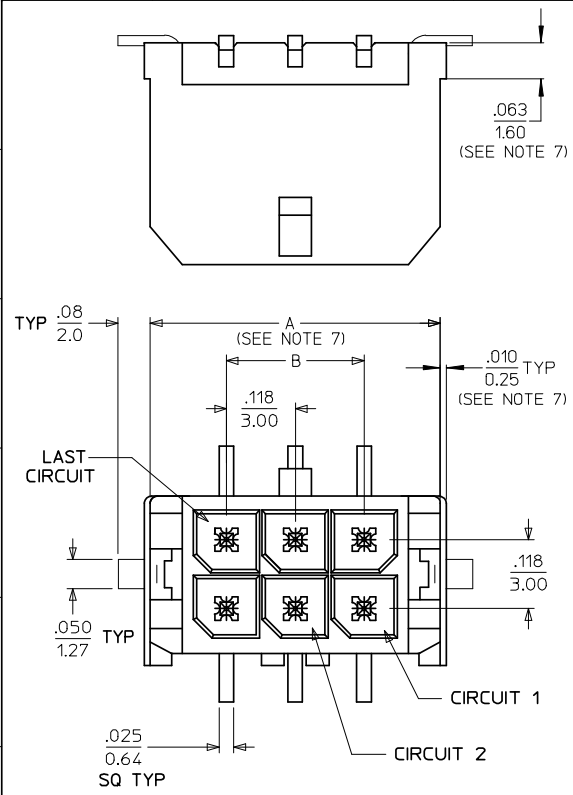

CIRCUIT "1" IDENTIFIED ON THIS SURFACE (APPROX. LOCATION SHOWN FOR REF.)

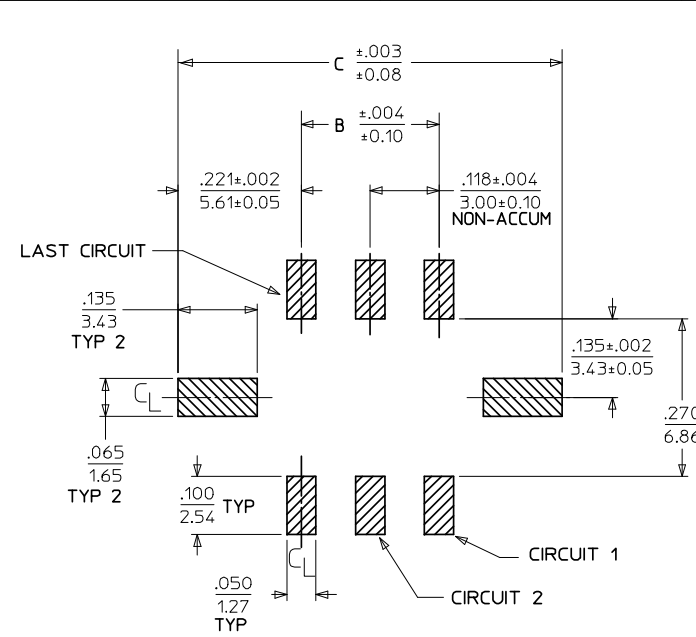

PCB LAYOUT: COMPONENT SIDE

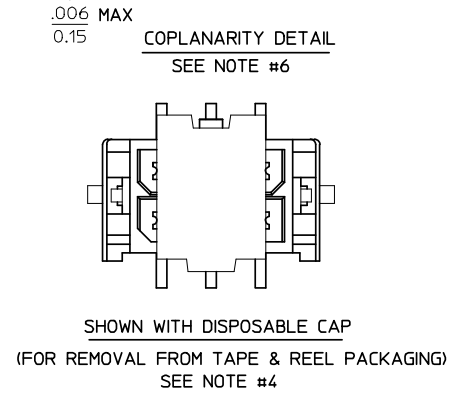
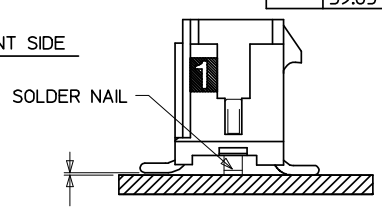

CKTS	A (SEE NOTE 7)		
	B	C	
02	.262		.441
	6.65	NA	11.20
04	.380	.118	.559
	9.65	3.00	14.20
06	.498	.236	.677
	12.65	6.00	17.20
08	.616	.354	.795
	15.65	9.00	20.20
10	.734	.472	.913
	18.65	12.00	23.20
12	.852	.591	1.031
	21.65	15.00	26.20
14	.970	.709	1.150
	24.65	18.00	29.20
16	1.088	.827	1.268
	27.65	21.00	32.20
18	1.206	.945	1.386
	30.65	24.00	35.20
20	1.325	1.063	1.504
	33.65	27.00	38.20
22	1.443	1.181	1.622
	36.65	30.00	41.20
24	1.561	1.299	1.740
	39.65	33.00	44.20

NOTES:

- HOUSING MATERIAL: GLASS FILLED LIQUID CRYSTAL POLYMER UL94V-0, COLOR: BLACK
TERMINAL MATERIAL: BRASS ALLOY
- FINISH: A = .000100/(0.00254) MIN. TIN OVER .000050/(0.00127) MIN. NICKEL PLATE.
B = .000015/(0.00038) MIN. SELECT GOLD IN CONTACT AREA, .000100/(0.00254) MIN. SELECT MATTE TIN ON SOLDER TAILS, BOTH OVER .000050/(0.00127) MIN. NICKEL PLATE.
C = .000030/(0.00076) MIN. SELECT GOLD IN CONTACT AREA, .000100/(0.00254) MIN. SELECT MATTE TIN ON SOLDER TAILS, BOTH OVER .000050/(0.00127) MIN. NICKEL PLATE.
* THE PRIMARY SHIPPING CARTON WILL BE LABELED "COMPLIANT TO RoHS DIRECTIVE 2002/95/EC AND ELV ANNEX II OF DIRECTIVE 2000/53/EC." CARTONS WITHOUT THIS LABEL MAY CONTAIN PRODUCT WITH TIN/LEAD IN THE PC TAIL AREA.
- PRODUCT SPECIFICATION: PS-43045
- TAPE AND REEL PACK : SEE MOLEX DRAWING PK-70873-05**
- MATES WITH MICRO FIT (3.0) RECEPTACLE SERIES 43025
- THE COPLANARITY DIMENSION IS ESTABLISHED BY PLACING THE ASSEMBLY ON A FLAT SURFACE. THE DISTANCE FROM THAT SURFACE TO THE BOTTOM OF ANY TERMINAL OR SOLDER NAIL MUST NOT EXCEED .006/0.15
- .010/0.25 OFFSETS ARE PRESENT ON ALL PARTS MANUFACTURED AFTER 11/1/2007, AND ON PARTS PRIOR TO 11/1/2007 THAT CONTAIN A GREEN DOT ON THE PRIMARY SHIPPING CARTON LABEL.
- THIS PART CONFORMS TO CLASS B REQUIREMENTS OF COSMETIC SPECIFICATION PS-45499-002.

	FINISH A	FINISH B	FINISH C
CKTS	MATERIAL NO:	MATERIAL NO:	MATERIAL NO:
02	43045-0218	43045-0219	43045-0220
04	43045-0418	43045-0419	43045-0420
06	43045-0618	43045-0619	43045-0620
08	43045-0818	43045-0819	43045-0820
10	43045-1018	43045-1019	43045-1020
12	43045-1218	43045-1219	43045-1220
14	43045-1418	43045-1419	43045-1420
16	43045-1618	43045-1619	43045-1620
18	43045-1818	43045-1819	43045-1820
20	43045-2018	43045-2019	43045-2020
22	43045-2218	43045-2219	43045-2220
24	43045-2418	43045-2419	43045-2420

REVISION NOTE 7 EC NO: UCP2008-0324 DRWN:WKP/PER 2007/12/19 CHKD:SS/USEK 2007/12/20 APPR:FSM/LTH 2007/12/21	QUALITY SYMBOLS ▽=0 ▽=0	GENERAL TOLERANCES (UNLESS SPECIFIED)		DIMENSION STYLE IN/MM		SCALE ---	DESIGN UNITS METRIC	THIRD ANGLE PROJECTION
		4 PLACES ± --- ± --- 3 PLACES ± --- ± .010 2 PLACES ± 0.25 ± .014 1 PLACE ± 0.36 ± --- ANGULAR ± 1/2°	mm INCH	DRAWN BY SAMIEC DATE 2000/03/15	TITLE MICRO FIT (3.0) DUAL ROW VERTICAL SMT HEADER W/NAILS ASS'Y			
		DRAFT WHERE APPLICABLE MUST REMAIN WITHIN DIMENSIONS		CHECKED BY MUELLER DATE 2000/03/15	MOLEX INCORPORATED			
		SEE CHART		APPROVED BY EDGLEY DATE 2000/03/15	DOCUMENT NO. SD-43045-007		SHEET NO. 1 OF 1	