

**PLEASE CHECK WWW.MOLEX.COM FOR LATEST PART INFORMATION**

**Part Number:** [501568-0907](#)  
**Status:** **Active**  
**Overview:** [Pico-Clasp™](#)  
**Description:** 1.00mm Pitch Pico-Clasp™ Wire-to-Board Header, Surface Mount, Single Row, Right Angle, with Positive Lock, 9 Circuits, Lead-Free

**Documents:**

[3D Model](#) [Packaging Specification SPK-501568-001 \(PDF\)](#)  
[Drawing \(PDF\)](#) [RoHS Certificate of Compliance \(PDF\)](#)  
[Product Specification PS-501568-001 \(PDF\)](#)

**Agency Certification**

UL E29179

**General**

Product Family PCB Headers  
 Series [501568](#)  
 Application Signal, Wire-to-Board  
 Overview [Pico-Clasp™](#)  
 Product Name Pico-Clasp™  
 UPC 822348871858

**Physical**

Breakaway No  
 Circuits (Loaded) 9  
 Circuits (maximum) 9  
 Color - Resin Natural  
 Durability (mating cycles max) 30  
 Flammability 94V-2  
 Glow-Wire Compliant No  
 Lock to Mating Part Yes  
 Material - Metal Brass, Phosphor Bronze  
 Material - Plating Mating Tin  
 Material - Plating Termination Tin  
 Material - Resin Nylon  
 Net Weight 197.900/mg  
 Number of Rows 1  
 Orientation Right Angle  
 PCB Locator No  
 PCB Retention Yes  
 Packaging Type Embossed Tape on Reel  
 Pitch - Mating Interface 1.00mm  
 Polarized to Mating Part Yes  
 Polarized to PCB No  
 Stackable No  
 Temperature Range - Operating -40°C to +85°C  
 Termination Interface: Style Surface Mount

**Electrical**

Current - Maximum per Contact 1A  
 Voltage - Maximum 50V AC (RMS)/DC

**Material Info**

**Reference - Drawing Numbers**

Packaging Specification SPK-501568-001

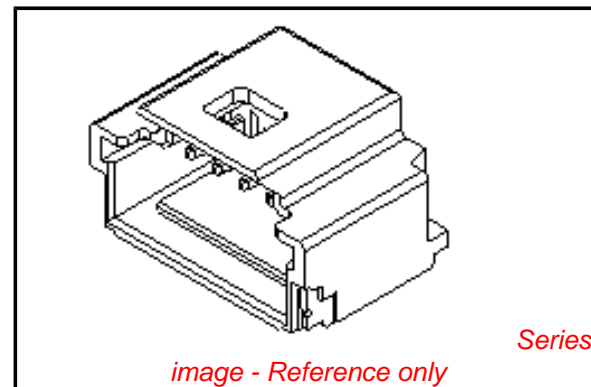

**EU RoHS**

**ELV and RoHS  
Compliant**

**REACH SVHC**

Not Reviewed

**Low-Halogen Status**

**Not Low-Halogen**

**China RoHS**



**Need more information on product  
environmental compliance?**

Email [productcompliance@molex.com](mailto:productcompliance@molex.com)  
 For a multiple part number RoHS Certificate of Compliance, [click here](#)

Please visit the [Contact Us](#) section for any non-product compliance questions.

**Search Parts in this Series**

501568Series

**Mates With**

501330 Pico-Clasp™ Wire-to-Board Female Housing

Product Specification

PS-501568-001, RPS-501331-001, RPS-501568-001,  
RPS-501568-002, RPS-501568-003, RPS-501568-004,  
RPS-501568-005, RPS-501568-009, RPS-501568-010,  
RPS-501568-011, RPS-501940-001, RPS-501940-002  
SD-501568-002, SD-501568-006

Sales Drawing

This document was generated on 06/05/2013

**PLEASE CHECK [WWW.MOLEX.COM](http://WWW.MOLEX.COM) FOR LATEST PART INFORMATION**