

NOTES

1. 嵌合相手: 502380-****
MATE WITH: 502380-****
2. 端子テール部 及び ネイルの平坦度: 0.1MAX.
TAIL AND NAIL COPLANARITY TO BE 0.1 MAX.
3. 極数/2=偶数に適用。
APPLY FOR CKT. SIZE / 2 = EVEN.
4. 端子テール部 及び ネイルに錫めっきを使用しているため、
外観に摺動痕が付く場合がございます。
THE WOUND OF FRICTION MIGHT ADHERE TO EXTERNALS
BECAUSE THE TIN PLATING IS USED FOR THA TAIL AND NAIL.
5. 本製品のプラスチック部に黒点等が確認される場合や
色合いが異なる場合がありますが、製品性能に影響はありません。
THERE IS NO INFLUENCE IN THE PRODUCT PERFORMANCE THOUGH
THE BLACK SPOT ETC. MIGHT BE CONFIRMED TO THE PLASTIC PART OF
THIS PRODUCT AND THE SHADE MIGHT BE DIFFERENT.
6. ELV 及び RoHS 適合品
ELV AND ROHS COMPLIANT

11.15	17.5	21	22.1	502382-15**	15
9.9	16.25	19.75	20.85	502382-14**	14
8.65	15	18.5	19.6	502382-13**	13
7.4	13.75	17.25	18.35	502382-12**	12
6.15	12.5	16	17.1	502382-11**	11
4.9	11.25	14.75	15.85	502382-10**	10
3.65	10	13.5	14.6	502382-09**	9
2.4	8.75	12.25	13.35	502382-08**	8
D	C	B	A	EMBOSSED TAPE PACKAGE	極数
				オーダー番号	ORDER No. CKT. NO.

番号 NO.	部品 PART	材質 MATERIAL
①	ハウジング HOUSING	耐熱性樹脂 UL94V-0 色: SHEET 3 参照 HEATPROOF RESIN UL94V-0 COLOR: SEE SHEET 3
②	ターミナル TERMINAL	銅合金 COPPER ALLOY 錫めっき: 1.0 micro-meter MIN. TIN (TAIL AREA) ニッケルめっき(下地): 1.0 micro-meter MIN. NICKEL (UNDER PLATING)
③	ネイル NAIL	銅合金 COPPER ALLOY 錫めっき: 1.0 micro-meter MIN. TIN ニッケルめっき(下地): 1.0 micro-meter MIN. NICKEL (UNDER PLATING)

REVISED EC NO: J2011-0737 DRWN:TKON CHKD: APPR:NUKITA	DESCRIPTION GENERAL TOLERANCES (UNLESS SPECIFIED)	10 UNDER ±0.2	10 OVER 30 UNDER ±0.25	30 OVER ±0.3	ANGULAR ±3 °	DRAFT WHERE APPLICABLE MUST REMAIN WITHIN DIMENSIONS	
		DIMENSION STYLE MM ONLY		SCALE 5:1	DESIGN UNITS METRIC	THIRD ANGLE PROJECTION	
		DRAWN BY T. MIYAZAKI		DATE 2006/08/28	TITLE 1.25 W/B CONN. SINGLE S/T REC. ASS'Y 8-15CKT.		
		CHECKED BY K. ASAKAWA		DATE 2006/08/28	APPROVED BY Y.O. ITO		
REV	REV	MATERIAL NO. SEE TABLE		DOCUMENT NO. SD-502382-002		SHEET NO. 1 OF 3	
SIZE A3 THIS DRAWING CONTAINS INFORMATION THAT IS PROPRIETARY TO MOLEX INCORPORATED AND SHOULD NOT BE USED WITHOUT WRITTEN PERMISSION							

10 9 8 7 6 5 4 3 2 1

F

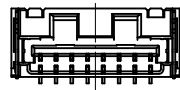

8 CKT.

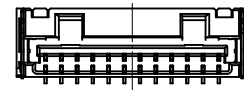

12 CKT.

E

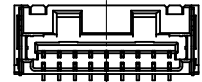

9 CKT.

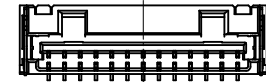

13 CKT.

D

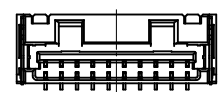

10 CKT.

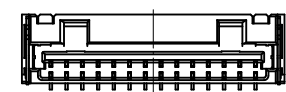

14 CKT.

C

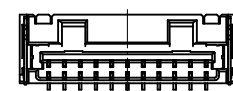

11 CKT.

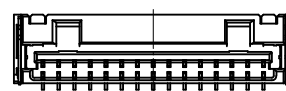

15 CKT.

B

極数の種類
KIND OF CKT. NO. (FRONT VIEW)

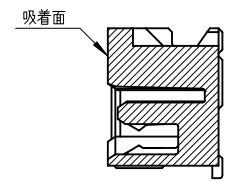
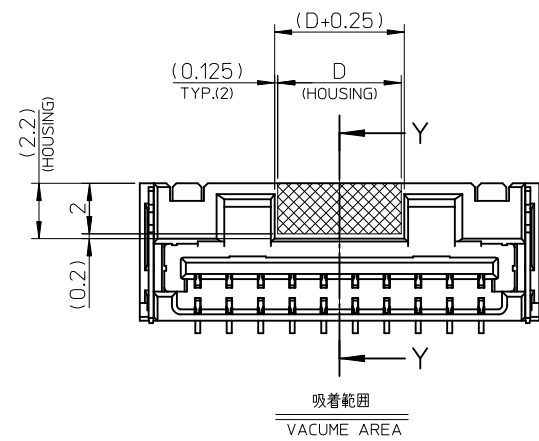

SECTION Y-Y

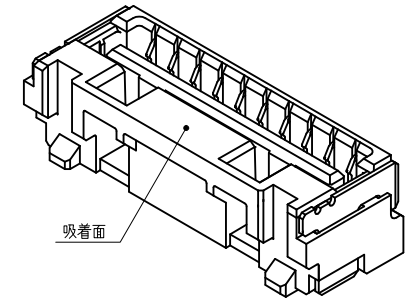
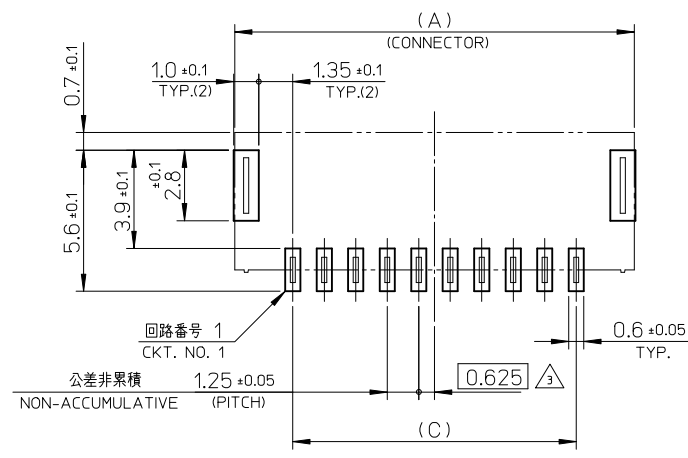

REVISED EC NO: J2011-0737 DRWN:TKGN 2010/11/29 CHKD: APPR:NUKITA 2010/11/29 REV:	GENERAL TOLERANCES (UNLESS SPECIFIED)		DIMENSION STYLE MM ONLY	SCALE 5:1	DESIGN UNITS METRIC	THIRD ANGLE PROJECTION
	10 UNDER	± 0.2	DRAWN BY T. MIYAZAKI	DATE 2006/08/28	TITLE 1.25 W/B CONN. SINGLE S/T REC. ASS'Y 8-15CKT.	
	10 OVER 30 UNDER	± 0.25	CHECKED BY K. ASAKAWA	DATE 2006/08/28	MOLEX INCORPORATED DOCUMENT NO. SD-502382-002 SHEET NO. 2 OF 3	
	30 OVER	± 0.3	APPROVED BY YO. ITO	DATE 2006/08/28		
ANGULAR ±3 °		MATERIAL NO. SEE TABLE		THIS DRAWING CONTAINS INFORMATION THAT IS PROPRIETARY TO MOLEX INCORPORATED AND SHOULD NOT BE USED WITHOUT WRITTEN PERMISSION		
DRAFT WHERE APPLICABLE MUST REMAIN WITHIN DIMENSIONS						

WITH CAPTON TAPE

HSG COLOR : GREEN		HSG COLOR : BLUE		HSG COLOR : YELLOW		HSG COLOR : RED		HSG COLOR : BLACK		HSG COLOR : NATURAL			
502382-1536	502382-**16	502382-1534	502382-**14	≡	502382-**13	502382-1532	502382-**12	502382-1531	502382-**11	502382-1572	502382-**08	15	
502382-1436		502382-1434		≡		502382-1432		502382-1431		502382-1472		14	
502382-1336		502382-1334		≡		502382-1332		502382-1331		502382-1372		13	
502382-1236		502382-1234		≡		502382-1232		502382-1231		502382-1272		12	
502382-1136		502382-1134		≡		502382-1132		502382-1131		502382-1172		11	
502382-1036		502382-1034		≡		502382-1032		502382-1031		502382-1072		10	
502382-0936		502382-0934		502382-0933		≡		502382-0932		502382-0931		502382-0972	9
502382-0836		502382-0834		≡		502382-0832		502382-0831		502382-0872		8	
EMBOSSSED TAPE PACKAGE オーダー番号ORDER No.	コネクタシリーズ CONNECTOR SERIES	EMBOSSSED TAPE PACKAGE オーダー番号ORDER No.	コネクタシリーズ CONNECTOR SERIES	EMBOSSSED TAPE PACKAGE オーダー番号ORDER No.	コネクタシリーズ CONNECTOR SERIES	EMBOSSSED TAPE PACKAGE オーダー番号ORDER No.	コネクタシリーズ CONNECTOR SERIES	EMBOSSSED TAPE PACKAGE オーダー番号ORDER No.	コネクタシリーズ CONNECTOR SERIES	EMBOSSSED TAPE PACKAGE オーダー番号ORDER No.	コネクタシリーズ CONNECTOR SERIES	極数 (KT. NO.)	

WITH CAPTON TAPE		
HSG COLOR : ORANGE		
≡	502382-**18	15
≡		14
≡		13
≡		12
≡		11
≡		10
502382-0938		9
≡		8
EMBOSSSED TAPE PACKAGE オーダー番号ORDER No.	コネクタシリーズ CONNECTOR SERIES	極数 (KT. NO.)

WITHOUT CAPTON TAPE		
HSG COLOR : NATURAL		
502382-1570	502382-**09	15
502382-1470		14
502382-1370		13
502382-1270		12
502382-1170		11
502382-1070		10
502382-0970		9
502382-0870		8
EMBOSSSED TAPE PACKAGE オーダー番号ORDER No.	コネクタシリーズ CONNECTOR SERIES	極数 (KT. NO.)

REVISED EC NO: J2011-0737 DRWN:TKGN 2010/11/29 CHKD: APPR:NUK ITA 2010/11/29	GENERAL TOLERANCES (UNLESS SPECIFIED)		DIMENSION STYLE MM ONLY		SCALE ----	DESIGN UNITS METRIC	THIRD ANGLE PROJECTION
	10 UNDER	±0.2	DRAWN BY T. MIYAZAKI	DATE 2006/08/28	TITLE 1.25 W/B CONN. SINGLE S/T REC. ASS'Y 8-15CKT.		
	10 OVER 30 UNDER	±0.25	CHECKED BY K. ASAKAWA	DATE 2006/08/28	MOLEX INCORPORATED		
	30 OVER	±0.3	APPROVED BY YO. ITO	DATE 2006/08/28	MATERIAL NO.	DOCUMENT NO.	SHEET NO.
	ANGULAR ±3 ° DRAFT WHERE APPLICABLE MUST REMAIN WITHIN DIMENSIONS		SEE TABLE		SD-502382-002	3 OF 3	

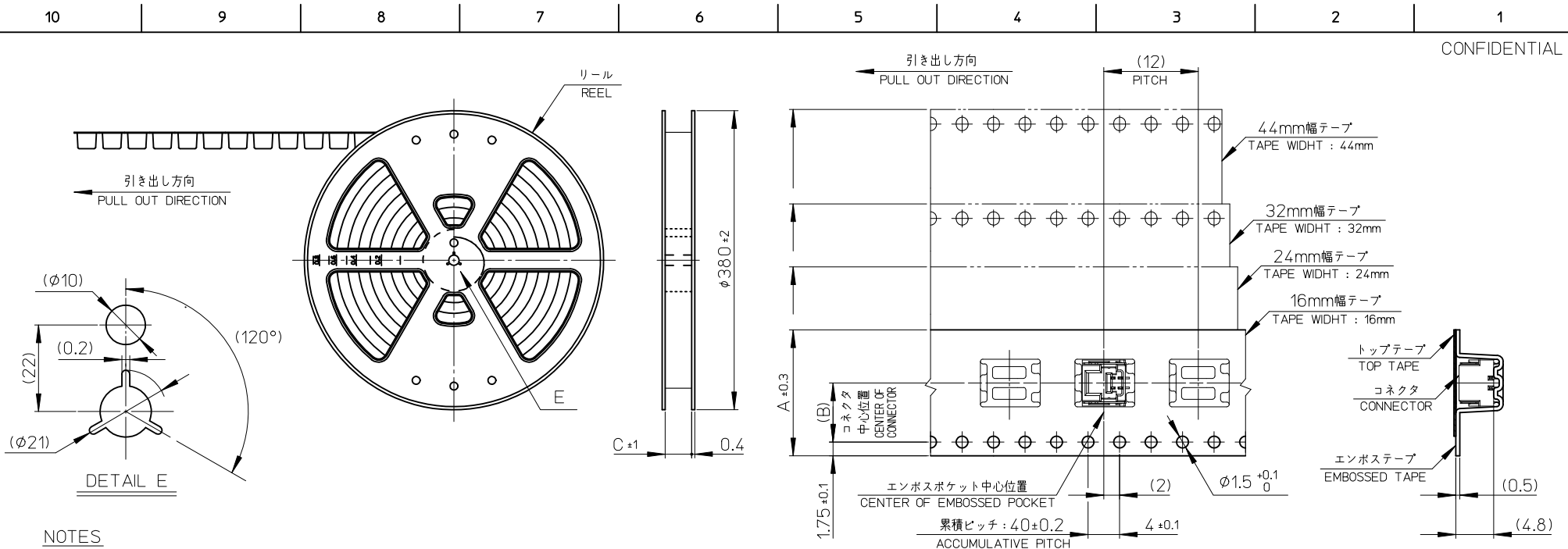

NOTES

- 製品詳細寸法については、SD-502382-001, -002 を参照下さい。
PLEASE REFER TO SD-502382-001, -002 FOR THE DETAILED DIMENSION OF THE CONNECTOR.
- 梱包数量 : 1400個
NUMBER OF CONNECTIONS : 1400 PIECES/REEL.
- リードテープ長さ
LEAD TAPE LENGTH

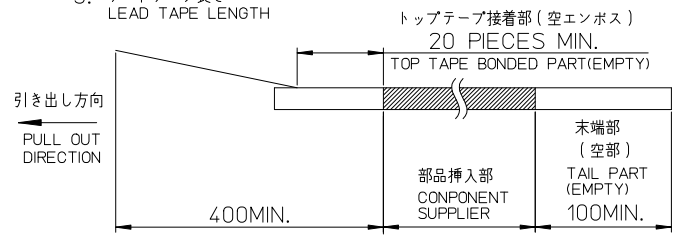

- 材料
MATERIAL
キャリアテープ : ポリスチレン
CARRIER TAPE : POLYSTYRENE
トップテープ : ポリエステル、ポリエチレン、ポリエチレンテレフタレート
TOP TAPE : POLYESTER, POLYETHYLENE, POLYETHYLENE TEREPHTHALATE
リール : ポリスチレン <リサイクル材を含む>
REEL : POLYSTYRENE <RECYCLE MATERIAL CONTAINED>
- ELV 及び RoHS 適合品
ELV AND RoHS COMPLIANT

45.5	20.2	44	502382-15**	15
45.5	20.2	44	502382-14**	14
33.5	14.2	32	502382-13**	13
33.5	14.2	32	502382-12**	12
33.5	14.2	32	502382-11**	11
33.5	14.2	32	502382-10**	10
25.5	11.5	24	502382-09**	9
25.5	11.5	24	502382-08**	8
25.5	11.5	24	502382-07**	7
25.5	11.5	24	502382-06**	6
25.5	11.5	24	502382-05**	5
25.5	11.5	24	502382-04**	4
17.5	7.5	16	502382-03**	3
17.5	7.5	16	502382-02**	2
C	B	エンボステープ幅 A WIDTH OF TAPE	製品番号 MATERIAL NO.	極数 EXT. NO.

REVISED EC NO: J2011-0737 DRWN:TKGN 2010/11/29 CHKD: APPR:NUKITA 2010/11/29	GENERAL TOLERANCES (UNLESS SPECIFIED)		DIMENSION STYLE MM ONLY		SCALE ---	DESIGN UNITS METRIC		THIRD ANGLE PROJECTION	
	10 UNDER	±0.2	DRAWN BY T. MIYAZAKI	DATE 2006/10/16	TITLE 1.25 W/B CONN. SINGLE S/T REC. EMBTP PKG				
	10 OVER 30 UNDER	±0.25	CHECKED BY K. ASAKAWA	DATE 2006/10/16	MOLEX INCORPORATED				
	30 OVER	±0.3	APPROVED BY YO. ITO	DATE 2006/10/16					
ANGULAR ±3 °		MATERIAL NO. SEE TABLE		DOCUMENT NO. SD-502382-003		SHEET NO. 1 OF 2			
DRAFT WHERE APPLICABLE MUST REMAIN WITHIN DIMENSIONS		SIZE A3 THIS DRAWING CONTAINS INFORMATION THAT IS PROPRIETARY TO MOLEX INCORPORATED AND SHOULD NOT BE USED WITHOUT WRITTEN PERMISSION							