

6	5.2	25	21	26.8	502585-157*	15
6	5.2	23.5	19.5	25.3	-147*	14
6	5.2	22	18	23.8	-137*	13
6	5.2	20.5	16.5	22.3	-127*	12
6	5.2	19	15	20.8	-117*	11
6	3.2	17.5	13.5	19.3	-107*	10
6	3.2	16	12	17.8	-097*	9
6	2.5	14.5	10.5	16.3	-087*	8
6	2.5	13	9	14.8	-077*	7
6	2.3	11.5	7.5	13.3	-067*	6
2.9	3.6	10	6	11.8	-057*	5
2.9	3.3	8.5	4.5	10.3	-047*	4
2.9	2.55	7	3	8.8	-037*	3
2.9	2.3	5.5	1.5	7.3	502585-027*	2
E	D	C	B	A	EMBOSSED TAPE PACKAGE	CIRCUIT No.
					ORDER No.	

No.	部品 PART	材料 MATERIAL
①	ハウジング HOUSING	耐熱性樹脂 UL94V-0 HEATPROOF RESIN UL94V-0
②	ターミナル TERMINAL	銅合金 COPPER ALLOY 鍍めつき:1.0 micro-meter MIN. TIN (TAIL AREA) ニッケルめつき(下地):1.0 micro-meter MIN. NICKEL (UNDER PLATING)
③	ネイル NAIL	銅合金 COPPER ALLOY 鍍めつき:1.0 micro-meter MIN. TIN ニッケルめつき(下地):1.0 micro-meter MIN. NICKEL (UNDER PLATING)

REVISED EC NO: J2010-0037 DRWN: ITO CHKD: ASAKAWA APPR: NUKITA	DESCRIPTION 2009/07/06 2009/07/07 2009/07/08	GENERAL TOLERANCES (UNLESS SPECIFIED)		DIMENSION STYLE MM ONLY	SCALE 4:1	DESIGN UNITS METRIC	THIRD ANGLE PROJECTION	
		10 UNDER ±0.2	10 OVER 30 UNDER ±0.25	DRAWN BY N. ITO	DATE '07/07/10	TITLE 1.5 W/B CONN. R/A REC. ASS'Y		
		30 OVER ±0.3	ANGULAR ±3 °	CHECKED BY K. ASAKAWA	DATE '07/07/11	MOLEX INCORPORATED		
		DRAFT WHERE APPLICABLE MUST REMAIN WITHIN DIMENSIONS		APPROVED BY Y. ITO	DATE '07/07/11	MATERIAL NO. SEE CHART	DOCUMENT NO. SD-502585-001	SHEET NO. 1 OF 3
THIS DRAWING CONTAINS INFORMATION THAT IS PROPRIETARY TO MOLEX INCORPORATED AND SHOULD NOT BE USED WITHOUT WRITTEN PERMISSION								

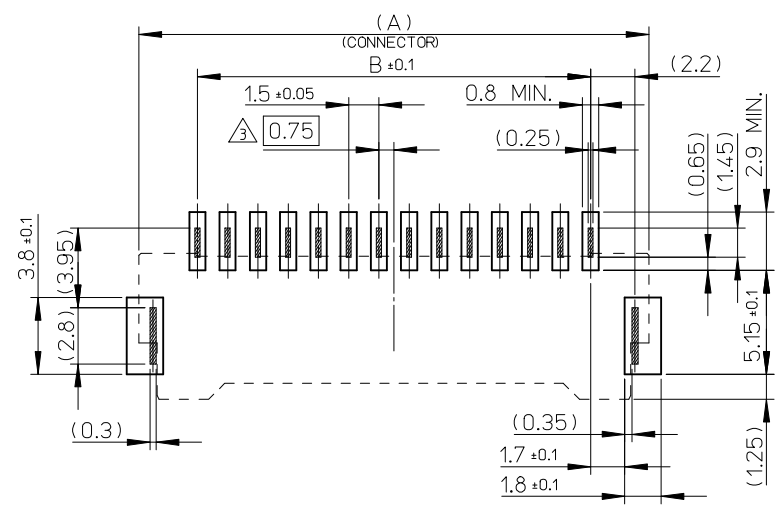

基板パターンレイアウト (参考)
RECOMMENDED P.C.B. PATTERN LAYOUT (REF.)

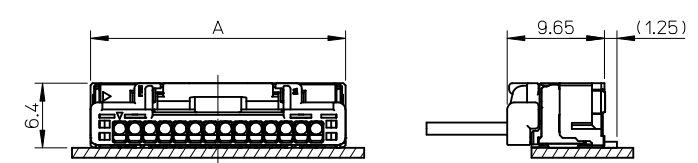

嵌合図
MATED CONNECTORS

NOTES

1. 嵌合相手: 502578 シリーズ
MATE WITH: 502578 SERIES.
2. 端子テール部及びネイルの平坦度: 0.1 MAX.
TAIL AND NAIL COPLANARITY TO BE 0.1 MAX.
3. 極数/2=偶数に適用
APPLY FOR CIRCUIT SIZE/2=EVEN.
4. 端子テール部及びネイルに錫めっきを使用している為、
外観に摺動痕が付く場合があります。
THE WOUND OF FRICTION MIGHT ADHERE TO EXTERNALS
BECAUSE THE TIN PLATING IS USED FOR THE TAIL AND NAIL.
5. 製品番号
MATERIAL No.

502585-***
CIRCUIT SIZE 色 COLOR

No.	COLOR	CIRCUIT
70	ベージュ BEIGE	2~15
71	黒 BLACK	
72	赤 RED	
73	黄 YELLOW	
74	青 BLUE	
75	桃 PINK	
76	緑 GREEN	
77	茶 BROWN	
78	橙 ORANGE	
79	紫 VIOLET	

6. 本製品のプラスチック部に黒点・白点等が確認される場合や
色合いが異なる場合がありますが、製品性能に影響はありません。
THERE IS NO INFLUENCE IN THE PRODUCT PERFORMANCE THOUGH THE BLACK AND WHITE SPOT ETC.
MIGHT BE CONFIRMED TO THE PLASTIC PART OF THIS PRODUCT AND THE SHADE MIGHT BE DIFFERENT.
7. ELV及びRoHS適合品
ELV AND RoHS COMPLIANT.

△ 8 ORDER No. AND CONNECTOR SERIES No.

REVISED EC NO: J2010-0037 DRWN: ITO CHKD: K. ASAKAWA APPR: NUKITA	DESCRIPTION 2009/07/06 2009/07/07 2009/07/08	GENERAL TOLERANCES (UNLESS SPECIFIED)		DIMENSION STYLE MM ONLY		SCALE 4:1	DESIGN UNITS METRIC	THIRD ANGLE PROJECTION		
		10 UNDER	±0.2	DRAWN BY N. ITO	DATE '07/07/10	TITLE 1.5 W/B CONN. R/A REC. ASS'Y				
		10 OVER 30 UNDER	±0.25	CHECKED BY K. ASAKAWA	DATE '07/07/11	MOLEX INCORPORATED				
		30 OVER	±0.3	APPROVED BY Y. ITO	DATE '07/07/11	MATERIAL NO. SEE CHART		DOCUMENT NO. SD-502585-001	SHEET NO. 2 OF 3	
ANGULAR ±3 °		DRAFT WHERE APPLICABLE MUST REMAIN WITHIN DIMENSIONS		THIS DRAWING CONTAINS INFORMATION THAT IS PROPRIETARY TO MOLEX INCORPORATED AND SHOULD NOT BE USED WITHOUT WRITTEN PERMISSION						

△ ORDER No. AND CONNECTOR SERIES No.

HSG COLOR : BLUE		HSG COLOR : YELLOW		HSG COLOR : RED		HSG COLOR : BLACK		HSG COLOR : BEIGE		
502585-1574	502585-***74	502585-1573	502585-***73	502585-1572	502585-***72	502585-1571	502585-***71	502585-1570	502585-***70	15
502585-1474		502585-1473		502585-1472		502585-1471		502585-1470		14
502585-1374		502585-1373		502585-1372		502585-1371		502585-1370		13
502585-1274		502585-1273		502585-1272		502585-1271		502585-1270		12
502585-1174		502585-1173		502585-1172		502585-1171		502585-1170		11
502585-1074		502585-1073		502585-1072		502585-1071		502585-1070		10
502585-0974		502585-0973		502585-0972		502585-0971		502585-0970		9
502585-0874		502585-0873		502585-0872		502585-0871		502585-0870		8
502585-0774		502585-0773		502585-0772		502585-0771		502585-0770		7
502585-0674		502585-0673		502585-0672		502585-0671		502585-0670		6
502585-0574		502585-0573		502585-0572		502585-0571		502585-0570		5
502585-0474		502585-0473		502585-0472		502585-0471		502585-0470		4
502585-0374		502585-0373		502585-0372		502585-0371		502585-0370		3
502585-0274		502585-0273		502585-0272		502585-0271		502585-0270		2
EMBOSSED TAPE PACKAGE オーダー番号ORDER No.	コネクタシリーズ CONNECTOR SERIES	EMBOSSED TAPE PACKAGE オーダー番号ORDER No.	コネクタシリーズ CONNECTOR SERIES	EMBOSSED TAPE PACKAGE オーダー番号ORDER No.	コネクタシリーズ CONNECTOR SERIES	EMBOSSED TAPE PACKAGE オーダー番号ORDER No.	コネクタシリーズ CONNECTOR SERIES	EMBOSSED TAPE PACKAGE オーダー番号ORDER No.	コネクタシリーズ CONNECTOR SERIES	極数 (KT. NO.)

HSG COLOR : VIOLET		HSG COLOR : ORANGE		HSG COLOR : BROWN		HSG COLOR : GREEN		HSG COLOR : PINK		
502585-1579	502585-***79	502585-1578	502585-***78	502585-1577	502585-***77	502585-1576	502585-***76	502585-1575	502585-***75	15
502585-1479		502585-1478		502585-1477		502585-1476		502585-1475		14
502585-1379		502585-1378		502585-1377		502585-1376		502585-1375		13
502585-1279		502585-1278		502585-1277		502585-1276		502585-1275		12
502585-1179		502585-1178		502585-1177		502585-1176		502585-1175		11
502585-1079		502585-1078		502585-1077		502585-1076		502585-1075		10
502585-0979		502585-0978		502585-0977		502585-0976		502585-0975		9
502585-0879		502585-0878		502585-0877		502585-0876		502585-0875		8
502585-0779		502585-0778		502585-0777		502585-0776		502585-0775		7
502585-0679		502585-0678		502585-0677		502585-0676		502585-0675		6
502585-0579		502585-0578		502585-0577		502585-0576		502585-0575		5
502585-0479		502585-0478		502585-0477		502585-0476		502585-0475		4
502585-0379		502585-0378		502585-0377		502585-0376		502585-0375		3
502585-0279		502585-0278		502585-0277		502585-0276		502585-0275		2
EMBOSSED TAPE PACKAGE オーダー番号ORDER No.	コネクタシリーズ CONNECTOR SERIES	EMBOSSED TAPE PACKAGE オーダー番号ORDER No.	コネクタシリーズ CONNECTOR SERIES	EMBOSSED TAPE PACKAGE オーダー番号ORDER No.	コネクタシリーズ CONNECTOR SERIES	EMBOSSED TAPE PACKAGE オーダー番号ORDER No.	コネクタシリーズ CONNECTOR SERIES	EMBOSSED TAPE PACKAGE オーダー番号ORDER No.	コネクタシリーズ CONNECTOR SERIES	極数 (KT. NO.)

REVISED EC NO: J2010-0037 DRWN: ITO CHK: K. ASAKAWA APPR: NUKITA	GENERAL TOLERANCES (UNLESS SPECIFIED)		DIMENSION STYLE MM ONLY		SCALE 4:1	DESIGN UNITS METRIC		THIRD ANGLE PROJECTION	
	10 UNDER	±0.2	DRAWN BY N. ITO	DATE '07/07/10	TITLE 1.5 W/B CONN. R/A REC. ASS'Y				
	10 OVER 30 UNDER	±0.25	CHECKED BY K. ASAKAWA	DATE '07/07/11	 MOLEX INCORPORATED				
	30 OVER	±0.3	APPROVED BY Y. ITO	DATE '07/07/11					
ANGULAR ±3 °		DRAFT WHERE APPLICABLE MUST REMAIN WITHIN DIMENSIONS		MATERIAL NO. SEE CHART		DOCUMENT NO. SD-502585-001		SHEET NO. 3 OF 3	
THIS DRAWING CONTAINS INFORMATION THAT IS PROPRIETARY TO MOLEX INCORPORATED AND SHOULD NOT BE USED WITHOUT WRITTEN PERMISSION									

10 9 8 7 6 5 4 3 2 1

引き出し方向
PULL OUT DIRECTION

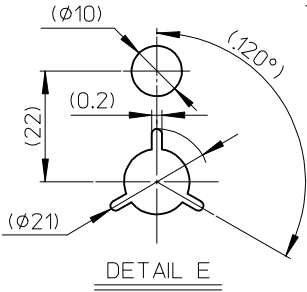
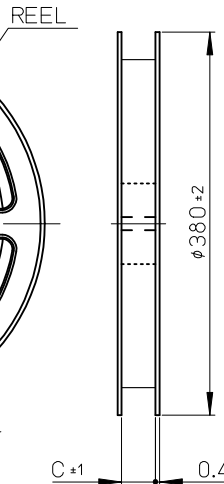
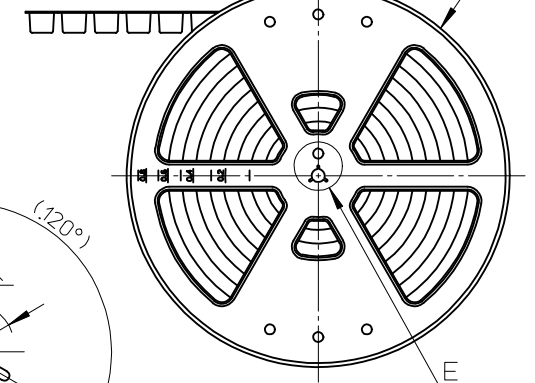

NOTES

- 製品詳細寸法については、SD-502585-001を参照下さい。
PLEASE REFER TO SD-502585-001 FOR THE DETAILED DIMENSION OF THE CONNECTOR.
- 梱包数量：1000個
NUMBER OF CONNECTIONS：1000 PIECES/REEL.
- リードテープ長さ
LEAD TAPE LENGTH

トップテープ接着部(空エンボス)
20 PIECES MIN.
TOP TAPE BONDED PART(EMPTY)

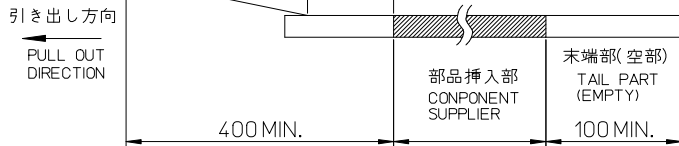

- 材料
MATERIAL
キャリアテープ：ポリスチレン
CARRIER TAPE：POLYSTYRENE
トップテープ：ポリエステル、ポリエチレン、ポリエチレンテレフタレート
TOP TAPE：POLYESTER, POLYETHYLENE, POLYETHYLENE TEREPHTHALATE
リール：ポリスチレン<リサイクル材を含む>
REEL：POLYSTYRENE <RECYCLE MATERIAL CONTAINED>

- ELV及びRoHS適合品
ELV AND RoHS COMPLIANT

製品番号
MATERIAL NO.

502585-****

極数 色
CIRCUIT SIZE COLOR

引き出し方向
PULL OUT DIRECTION

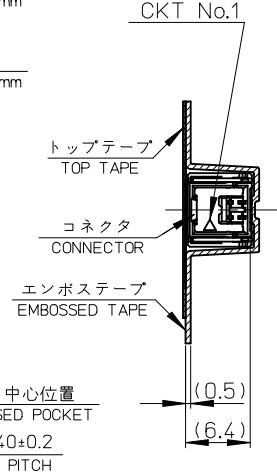
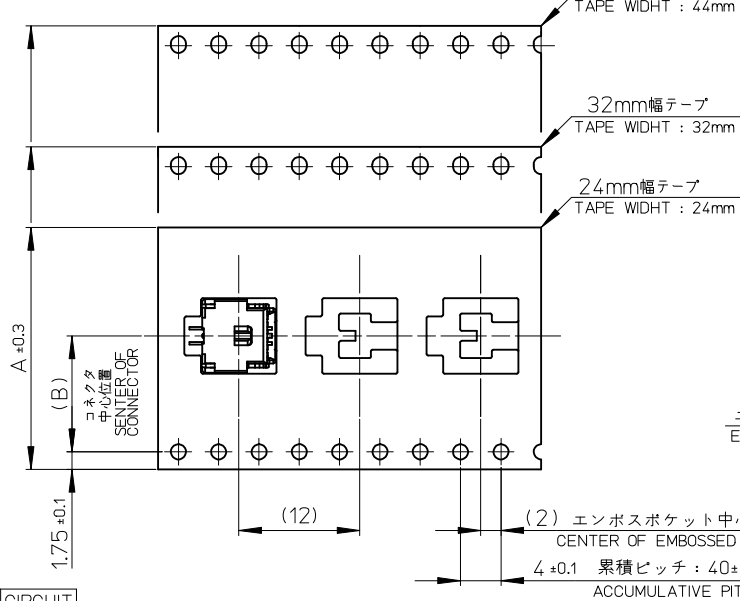

No.	COLOR	CIRCUIT
70	ベージュ BEIGE	2~15
71	黒 BLACK	
72	赤 RED	
73	黄 YELLOW	
74	青 BLUE	
75	桃 PINK	
76	緑 GREEN	
77	茶 BROWN	
78	橙 ORANGE	
79	紫 VIOLET	

ORDER No. AND CONNECTOR SERIES No.

- 本製品は乾燥剤入り、ハイバリア梱包仕様である。
THIS PRODUCT IS HIGH BARRIER PACKAGE WITH DESICCANT.

45.5	20.2	44	502585-157*	15
45.5	20.2	44	-147*	14
45.5	20.2	44	-137*	13
45.5	20.2	44	-127*	12
45.5	20.2	44	-117*	11
45.5	20.2	44	-107*	10
33.5	14.2	32	-097*	9
33.5	14.2	32	-087*	8
33.5	14.2	32	-077*	7
33.5	14.2	32	-067*	6
25.5	11.5	24	-057*	5
25.5	11.5	24	-047*	4
25.5	11.5	24	-037*	3
25.5	11.5	24	502585-027*	2
C	B	エンボステープ幅A WIDTH OF TAPE	製品番号 MATERIAL NO.	極数 CKT. NO.

REVISED	EC NO. J2010-0624	DRWN:NITO 2009/10/07	CHKD:KASAKAWA 2009/10/07	APPR:NUKITA 2009/10/08	DESCRIPTION	GENERAL TOLERANCES (UNLESS SPECIFIED)		DIMENSION STYLE		SCALE	DESIGN UNITS		TITLE
						10 UNDER	±0.2	MM ONLY	---	METRIC	THIRD ANGLE PROJECTION		
						10 OVER	±0.25	DRAWN BY	DATE				EMBOSSSED TAPE PACKAGE FOR 502585
						30 OVER	±0.3	CHECKED BY	DATE				
						ANGULAR	±1 °	APPROVED BY	DATE				
						DRAFT WHERE APPLICABLE MUST REMAIN WITHIN DIMENSIONS		Y01TO	2007/07/17				
								MATERIAL NO.		SEE TABLE			MOLEX INCORPORATED
								SIZE	A3				SD-502585-002
								THIS DRAWING CONTAINS INFORMATION THAT IS PROPRIETARY TO MOLEX INCORPORATED AND SHOULD NOT BE USED WITHOUT WRITTEN PERMISSION					SHEET NO. 1 OF 2

△ ORDER No. AND CONNECTOR SERIES No.

HSG COLOR : BLUE		HSG COLOR : YELLOW		HSG COLOR : RED		HSG COLOR : BLACK		HSG COLOR : BEIGE		
502585-**74	502585-1574	502585-**73	502585-1573	502585-**72	502585-1572	502585-**71	502585-1571	502585-**70	502585-1570	15
	502585-1474		502585-1473		502585-1472		502585-1471		502585-1470	14
	502585-1374		502585-1373		502585-1372		502585-1371		502585-1370	13
	502585-1274		502585-1273		502585-1272		502585-1271		502585-1270	12
	502585-1174		502585-1173		502585-1172		502585-1171		502585-1170	11
	502585-1074		502585-1073		502585-1072		502585-1071		502585-1070	10
	502585-0974		502585-0973		502585-0972		502585-0971		502585-0970	9
	502585-0874		502585-0873		502585-0872		502585-0871		502585-0870	8
	502585-0774		502585-0773		502585-0772		502585-0771		502585-0770	7
	502585-0674		502585-0673		502585-0672		502585-0671		502585-0670	6
	502585-0574		502585-0573		502585-0572		502585-0571		502585-0570	5
	502585-0474		502585-0473		502585-0472		502585-0471		502585-0470	4
	502585-0374		502585-0373		502585-0372		502585-0371		502585-0370	3
	502585-0274		502585-0273		502585-0272		502585-0271		502585-0270	2
コネクタ シリーズ CONNECTOR SERIES	製品番号 MATERIAL NO.	コネクタ シリーズ CONNECTOR SERIES	製品番号 MATERIAL NO.	コネクタ シリーズ CONNECTOR SERIES	製品番号 MATERIAL NO.	コネクタ シリーズ CONNECTOR SERIES	製品番号 MATERIAL NO.	コネクタ シリーズ CONNECTOR SERIES	製品番号 MATERIAL NO.	極数 (K.T. NO.)

HSG COLOR : VIOLET		HSG COLOR : ORANGE		HSG COLOR : BROWN		HSG COLOR : GREEN		HSG COLOR : PINK		
502585-**79	502585-1579	502585-**78	502585-1578	502585-**77	502585-1577	502585-**76	502585-1576	502585-**75	502585-1575	15
	502585-1479		502585-1478		502585-1477		502585-1476		502585-1475	14
	502585-1379		502585-1378		502585-1377		502585-1376		502585-1375	13
	502585-1279		502585-1278		502585-1277		502585-1276		502585-1275	12
	502585-1179		502585-1178		502585-1177		502585-1176		502585-1175	11
	502585-1079		502585-1078		502585-1077		502585-1076		502585-1075	10
	502585-0979		502585-0978		502585-0977		502585-0976		502585-0975	9
	502585-0879		502585-0878		502585-0877		502585-0876		502585-0875	8
	502585-0779		502585-0778		502585-0777		502585-0776		502585-0775	7
	502585-0679		502585-0678		502585-0677		502585-0676		502585-0675	6
	502585-0579		502585-0578		502585-0577		502585-0576		502585-0575	5
	502585-0479		502585-0478		502585-0477		502585-0476		502585-0475	4
	502585-0379		502585-0378		502585-0377		502585-0376		502585-0375	3
	502585-0279		502585-0278		502585-0277		502585-0276		502585-0275	2
コネクタ シリーズ CONNECTOR SERIES	製品番号 MATERIAL NO.	コネクタ シリーズ CONNECTOR SERIES	製品番号 MATERIAL NO.	コネクタ シリーズ CONNECTOR SERIES	製品番号 MATERIAL NO.	コネクタ シリーズ CONNECTOR SERIES	製品番号 MATERIAL NO.	コネクタ シリーズ CONNECTOR SERIES	製品番号 MATERIAL NO.	極数 (K.T. NO.)

REVISED EC NO: J2010-0624 2009/10/07 DRWN: NITO 2009/10/07 CHKD: KASAKAWA 2009/10/07 APPR: NUKITA 2009/10/08	GENERAL TOLERANCES (UNLESS SPECIFIED)		DIMENSION STYLE MM ONLY		SCALE ---	DESIGN UNITS METRIC	THIRD ANGLE PROJECTION	
	10 UNDER	±0.2	DRAWN BY NITO	DATE 2007/07/17	TITLE EMBOSSSED TAPE PACKAGE FOR 502585			
	10 OVER 30 UNDER	±0.25	CHECKED BY KASAKAWA	DATE 2007/07/17	MOLEX MOLEX INCORPORATED			
	30 OVER	±0.3	APPROVED BY YOITO	DATE 2007/07/17				
	ANGULAR ±1 °		MATERIAL NO. SEE TABLE		DOCUMENT NO. SD-502585-002		SHEET NO. 2 OF 2	
DRAFT WHERE APPLICABLE MUST REMAIN WITHIN DIMENSIONS		SIZE A3 THIS DRAWING CONTAINS INFORMATION THAT IS PROPRIETARY TO MOLEX INCORPORATED AND SHOULD NOT BE USED WITHOUT WRITTEN PERMISSION						