

【目次 CONTENTS】

項番 No.	内容 Content	Page
1.	適用範囲 SCOPE	2
2.	製品名称及び型番 PRODUCT NAME AND PART NUMBER	2
3.	回路設計に関して DESIGN PROCESS	3
4.	実装に関して SMT PROCESS	5
5.	嵌合に関して MATING OPERATION	8
6.	抜去に関して UN-MATING OPERATION	12

REV.	A																					
SHEET	1-14																					
REVISE ON PC ONLY										TITLE: 0.35 BB CONN. HGT=0.6 SSB6 RP APPLICATION SPECIFICATION												
A	RELEASED 169219 2017/12/07 T.NAKAGAWA										アプリケーション仕様書											
	THIS DOCUMENT CONTAINS INFORMATION THAT IS PROPRIETARY TO MOLEX ELECTRONIC TECHNOLOGIES, LLC AND SHOULD NOT BE USED WITHOUT WRITTEN PERMISSION																					
REV.	DESCRIPTION																					
DESIGN CONTROL J					STATUS					WRITTEN BY: T.NAKAGAWA01			CHECKED BY: M.SASAO			APPROVED BY: M.SASAO			DATE: 2017/12/07			
DOCUMENT NUMBER 5050660000										DOC. TYPE PS			DOC. PART A06			CUSTOMER GENERAL				SHEET 1 OF 14		
EN-127(2015-12)																						

【1. 適用範囲 SCOPE】

_____ 殿 に納入する
0.35 mm ピッチ 基板対基板用 コネクタの取り扱いについて規定する。
This specification covers handling of the 0.35 mm PITCH BOARD TO BOARD CONNECTOR series.

【2. 製品名称及び型番 PRODUCT NAME AND PART NUMBER】

製品名称 Product Name	製品型番 Part Number
リセプタクル ハウジング アッセンブリ Receptacle Housing Assembly	5 0 5 0 6 6 - * * 0 9
5 0 5 0 6 6 - * * 0 9 エンボス梱包品 Embossed Tape Package For 505066-**09	5 0 5 0 6 6 - * * 2 2
プラグ ハウジング アッセンブリ Plug Housing Assembly	5 0 5 0 7 0 - * * 1 9 / - * * 3 9
5 0 5 0 7 0 - * * 1 9 / - * * 3 9 エンボス梱包品 Embossed Tape Package For 505070-**19/-**39	5 0 5 0 7 0 - * * 2 2 / - * * 4 2

注記)

この取扱い説明書はリセプタクル（以下リセ）側がFPC、プラグ側が基板（硬質基板）に実装された場合を想定して作成していますが、リセ側が基板（硬質基板）、プラグ側がFPCの場合にも適用します。
リセは変形しやすいばね端子を内蔵しておりますので、FPCに実装する場合は、特に抜去作業にご注意ください。

Notes)

This specification is issued based on the supposition that the receptacle is mounted on FPC and the plug is mounted on PWB (Hard PWB).
In the case of the receptacle is mounted on PWB (Hard PWB) and the plug is mounted on FPC is also covered. Receptacle contains formable terminal. So please pay attention to un-mating process of connectors if you mount Receptacle on FPC.

A	REVISE ON PC ONLY	TITLE: 0.35 BB CONN. HGT=0.6 SSB6 RP APPLICATION SPECIFICATION /アプリケーション仕様書	THIS DOCUMENT CONTAINS INFORMATION THAT IS PROPRIETARY TO MOLEX ELECTRONIC TECHNOLOGIES, LLC AND SHOULD NOT BE USED WITHOUT WRITTEN PERMISSION
	SEE SHEET 1 OF 14		
REV.	DESCRIPTION		
DOCUMENT NUMBER 5050660000	DOC. TYPE PS	DOC. PART A06	CUSTOMER GENERAL
			SHEET 2 OF 14
EN-127(2015-12)			

【3. 回路設計に関して DESIGNING WIRING】

3-1. コネクタの定格電流に関して CURRENT RATE OF CONNECTOR

3-1-1. コネクタ構造 CONNECTOR STRUCTURE

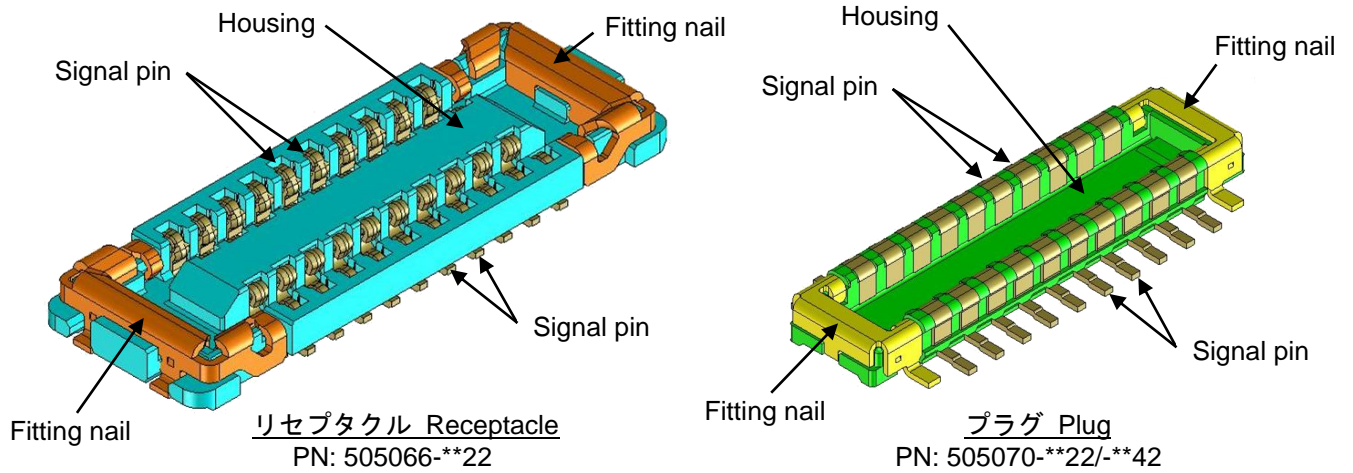

3-1-2. 定格電流に関して CURRENT RATE

コネクタの定格電流に関しては製品仕様書を確認ください。

Regarding the spec of current rating of this product, please confirm the product specification document.

3-2. 電源回路の設計時の注意点 NOTES OF CAUTION ABOUT WIRTING OF POWER CIRCUIT

3-2-1. 本コネクタを搭載する基板(PWB/FPC)において、過度な温度上昇を避ける為、適切なパターンデザインを行ってください。

To prevent excessive temperature increase, please make appropriate circuit design for PWB/FPC on which the connectors mount.

REVISE ON PC ONLY		TITLE:			
A	SEE SHEET 1 OF 14	0.35 BB CONN. HGT=0.6 SSB6 RP APPLICATION SPECIFICATION /アプリケーション仕様書			
	REV.	DESCRIPTION	THIS DOCUMENT CONTAINS INFORMATION THAT IS PROPRIETARY TO MOLEX ELECTRONIC TECHNOLOGIES, LLC AND SHOULD NOT BE USED WITHOUT WRITTEN PERMISSION		
DOCUMENT NUMBER 5050660000		DOC. TYPE PS	DOC. PART A06	CUSTOMER GENERAL	SHEET 3 OF 14

3-3. アプリケーションの設計に関して DESIGN APPLICATION

3-3-1. コネクタのアプリケーションへの搭載に関して、メイン基板にはプラグコネクタ、FPCにはリセコネクタを搭載することを推奨します。コネクタの構造上、プラグコネクタはリセコネクタに比べ端子の露出が多く、アプリケーションに搭載後に異物等が付着することにより短絡するリスクが高くなります。Regarding SMT of connector, the combination of receptacle on FPC and plug on PWB is recommended due to reduce the risk of short circuit. As shown in below figures, the pins of plug are more exposed in comparison with receptacle. So plug has higher risk of short circuit by contact with foreign objects than receptacle structurally.

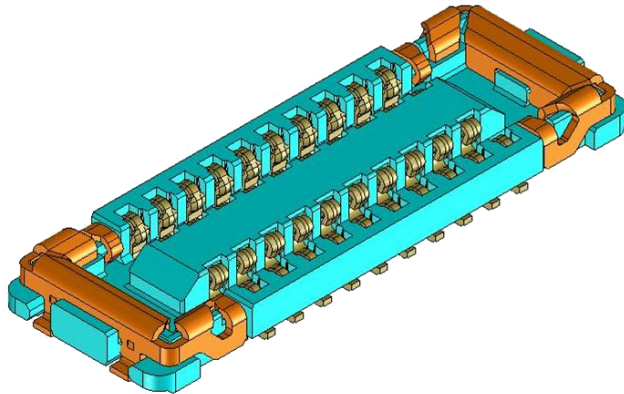

リセプタクル Receptacle
PN: 505066-**22

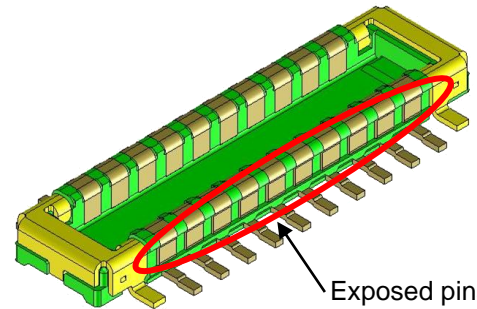

プラグ Plug
PN: 505070-**22/-**42

A	REVISE ON PC ONLY	TITLE: 0.35 BB CONN. HGT=0.6 SSB6 RP APPLICATION SPECIFICATION /アプリケーション仕様書			
	SEE SHEET 1 OF 14				
REV.	DESCRIPTION	THIS DOCUMENT CONTAINS INFORMATION THAT IS PROPRIETARY TO MOLEX ELECTRONIC TECHNOLOGIES, LLC AND SHOULD NOT BE USED WITHOUT WRITTEN PERMISSION			
DOCUMENT NUMBER 5050660000		DOC. TYPE PS	DOC. PART A06	CUSTOMER GENERAL	SHEET 4 OF 14

【4. 実装に関して SMT PROCESS】

4-1. 基板(PWB/FPC)の状態に関して PWB/FPC CONDITION

- 4-1-1. 基板の反りはコネクタ両端部を基準とし、コネクタ中央部にて Max0.02mmとしてください。
The warpage of PWB should be a maximum of 0.02mm if measuring from one connector edge to the other.
- 4-1-2. FPCに実装する場合は、基板の変形を防止するため、補強板のご使用をお勧めします。FR-4 0.5mm厚以上、SUS 0.2mm厚以上、もしくはそれ同等以上の強度を有する補強板の使用をお勧めします。
Recommend to place any stiffener board or film on the backside of FPC when you mount the connector to prevent deformation. Recommended material and thickness of stiffener board is FR-4 T \geq 0.5mm, SUS T \geq 0.2mm or more stronger.

4-2. 実装条件に関して SOLDERING CONDITION

- 4-2-1. 半田耐熱性のリフロー条件に関しては製品仕様書を確認ください。
Regarding the reflow condition for resistance to soldering heat, please confirm the product specification document.
- 4-2-2. 推奨ランド寸法 及び 推奨メタルマスクに関しては製品図面、製品仕様書に記載していますが、リフロー装置及び基板などにより条件が異なりますので事前に実装評価（リフロー評価）の御確認を御願ひ致します。
Recommended PWB layout and stencil is written in the drawing and the product specification document. However, please check the mount condition (reflow soldering condition) by your own devices beforehand, because the condition changes by the soldering devices, PWB, and so on.

A	REVISE ON PC ONLY	TITLE: 0.35 BB CONN. HGT=0.6 SSB6 RP APPLICATION SPECIFICATION /アプリケーション仕様書				
	SEE SHEET 1 OF 14				THIS DOCUMENT CONTAINS INFORMATION THAT IS PROPRIETARY TO MOLEX ELECTRONIC TECHNOLOGIES, LLC AND SHOULD NOT BE USED WITHOUT WRITTEN PERMISSION	
REV.	DESCRIPTION	DOCUMENT NUMBER	DOC. TYPE	DOC. PART	CUSTOMER	SHEET
		5050660000	PS	A06	GENERAL	5 OF 14
EN-127(2015-12)						

4-3. 実装時の注意点 NOTES OF CAUTION ABOUT SMT

4-3-1. ランド形状が弊社推奨寸法よりもコネクタ底面側に広い場合、コネクタの半田付け部以外に半田が付着し、製品性能が低下する可能性があります。弊社推奨ランド形状と異なる場合は、下図のように半田付け部以外に半田が付着しないように設定してください。

If the layout of PWB and solder paste is not same to molex recommendation, especially the pad extends to the direction under the connector, there is higher risk to significant performance degradation of connector by soldered the outside the zone of solder tail. In case of tracing the individual layout not same to molex recommendation, please design not to solder the outside the zone of solder tail.

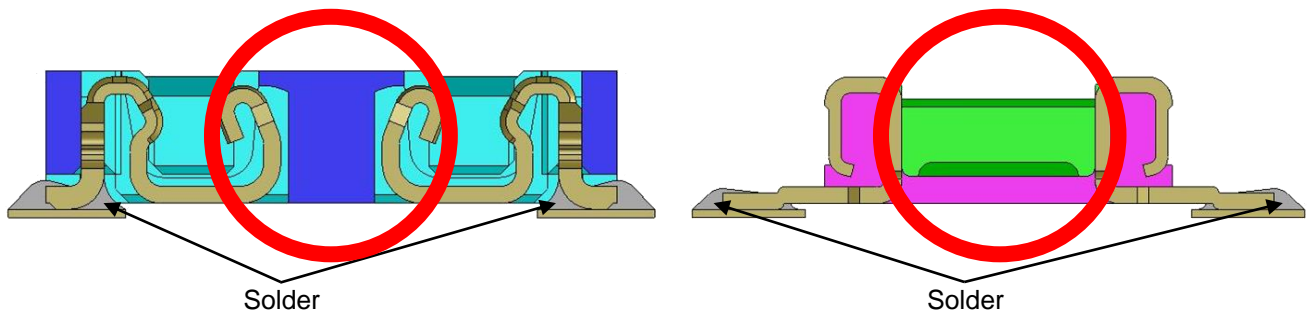

推奨基板での半田付け状態イメージ
Soldering image on recommended PWB

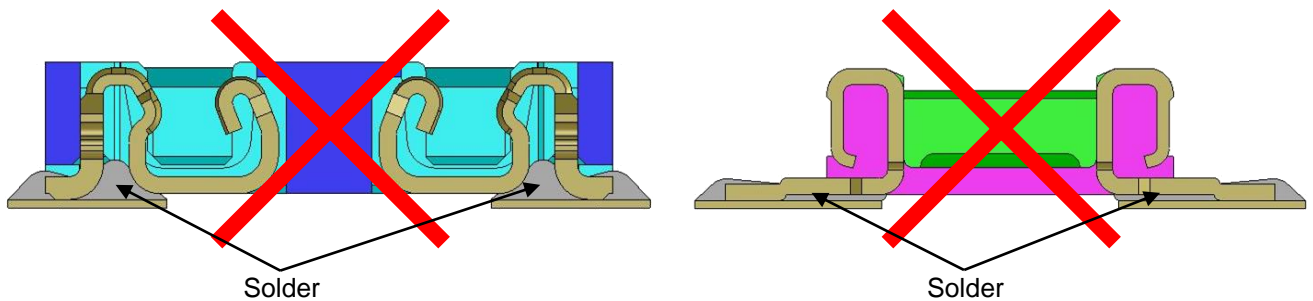

推奨外基板での半田付け状態イメージ
Soldering image on non-recommended PWB

REVISE ON PC ONLY		TITLE: 0.35 BB CONN. HGT=0.6 SSB6 RP APPLICATION SPECIFICATION /アプリケーション仕様書			
A	SEE SHEET 1 OF 14				
REV.	DESCRIPTION	THIS DOCUMENT CONTAINS INFORMATION THAT IS PROPRIETARY TO MOLEX ELECTRONIC TECHNOLOGIES, LLC AND SHOULD NOT BE USED WITHOUT WRITTEN PERMISSION			
DOCUMENT NUMBER 5050660000		DOC. TYPE PS	DOC. PART A06	CUSTOMER GENERAL	SHEET 6 OF 14

4-3-2. 半田量が多い、もしくはリフロー条件の違いにより、プラグコネクタのテール上面に半田が多く付着することがあります。テール上面に0.06mm以上の半田が付着すると嵌合後にリセハウジングと接触し、嵌合が浮く可能性がありますので、注意の上 半田量、リフロー条件を設定してください。
 There is the possible to be located the solder on the top of plug solder tail in case of large volume or higher reflow condition etc. If there is the solder higher than 0.06mm on solder tail, some trouble might occurred after mating (ex. Half mating, housing damage on receptacle side). Please take care the solder volume and reflow condition.

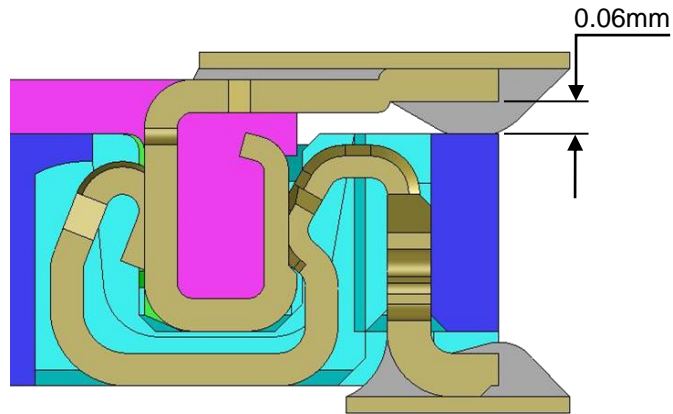

Plug テール部の半田過多のイメージ
 Extra solder volume image on plug tail

REVISE ON PC ONLY		TITLE:			
A	SEE SHEET 1 OF 14	0.35 BB CONN. HGT=0.6 SSB6 RP APPLICATION SPECIFICATION /アプリケーション仕様書			
	REV.	DESCRIPTION	THIS DOCUMENT CONTAINS INFORMATION THAT IS PROPRIETARY TO MOLEX ELECTRONIC TECHNOLOGIES, LLC AND SHOULD NOT BE USED WITHOUT WRITTEN PERMISSION		
DOCUMENT NUMBER 5050660000		DOC. TYPE PS	DOC. PART A06	CUSTOMER GENERAL	SHEET 7 OF 14

【5. 嵌合に関して MATING OPERATION】

5-1. 嵌合方法（挿入方法）HOW TO MATE (INSERTION)

嵌合時（挿入時）は正しく位置合わせを行ってください。正しく位置合わせすると、基板間が約0.85mmになります。その後、プラグ側をリセ側と平行に保ったまま挿入して頂けます様、宜しくお願い致します。
After positioning correctly for mating, then the distance between PWB and FPC is around 0.85mm, insert the plug to the receptacle in parallel with each other.

STEP 1

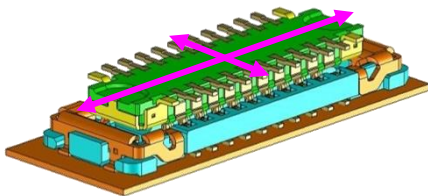

正しい位置合わせは右図の様に、リセ外壁とプラグ外壁で行ってください。
Please find correct position at outside wall of receptacle and outside wall of plug.

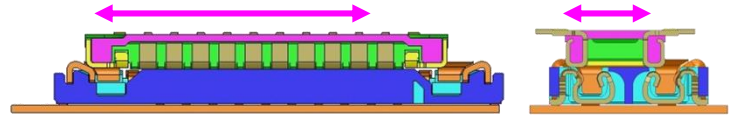

プラグ側をリセ側と平行にして位置合わせをしてください。
Positioning the plug correctly in parallel with the receptacle.

STEP 2

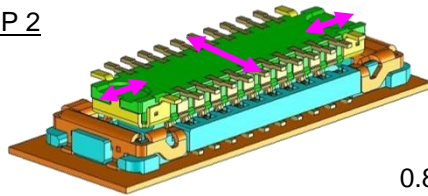

0.85mm

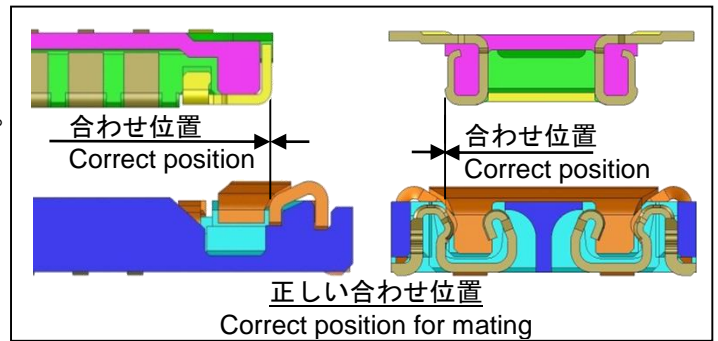

プラグ側を軽く動かし、位置合わせが正しいか確認してください。
Position the plug correct by adjusting back or forth.

STEP 3

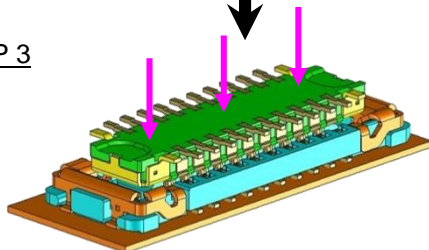

プラグ側をリセ側と平行に押し込んでください。
Insert the plug in parallel with the receptacle until fully seated.

STEP 4

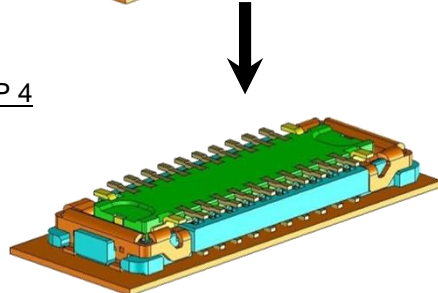

REVISE ON PC ONLY	
A	SEE SHEET 1 OF 14
REV.	DESCRIPTION

TITLE:
0.35 BB CONN. HGT=0.6 SSB6 RP
APPLICATION SPECIFICATION
/アプリケーション仕様書

THIS DOCUMENT CONTAINS INFORMATION THAT IS PROPRIETARY TO MOLEX ELECTRONIC TECHNOLOGIES, LLC AND SHOULD NOT BE USED WITHOUT WRITTEN PERMISSION

DOCUMENT NUMBER 5050660000	DOC. TYPE PS	DOC. PART A06	CUSTOMER GENERAL	SHEET 8 OF 14
-------------------------------	-----------------	------------------	---------------------	------------------

5-2. 嵌合時位置合わせ方法 (平行な位置合わせが困難な場合) MATING POSITIONING WITH SLIGHTLY INCLINED
5-2-1. 長手方向に自由度がある場合 When operated in "a" direction (lengthways)

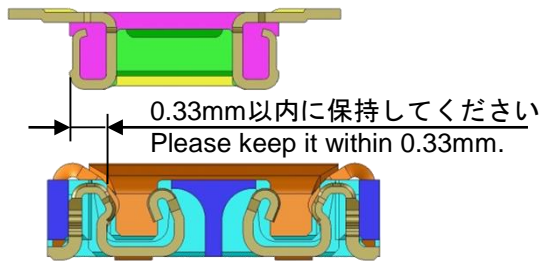

短手方向 "b" direction (widthways)

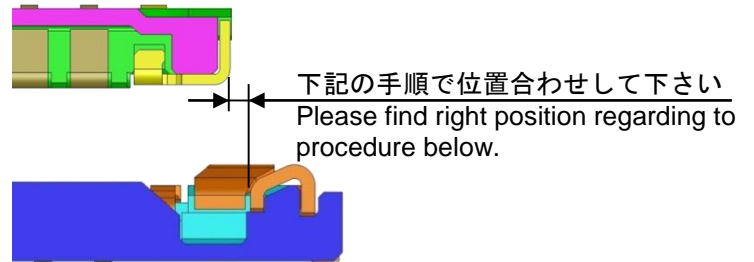

長手方向 "a" direction (lengthways)

STEP 1

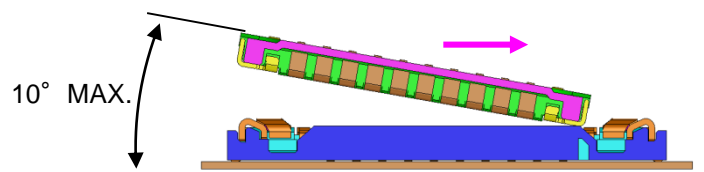
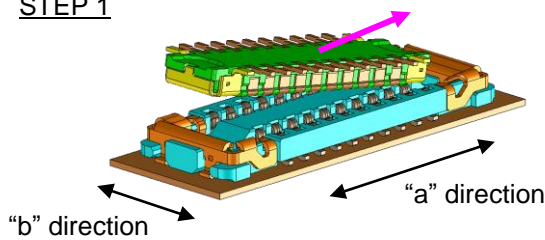

嵌合時の位置合わせは、プラグ側を少し傾けて (10° 以下) 行ってください。
Position for mating by inclining the plug to the receptacle approximately less than 10° .

STEP 2

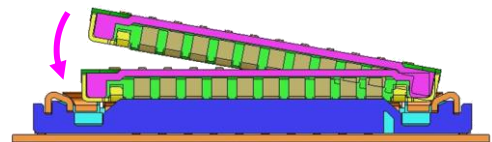
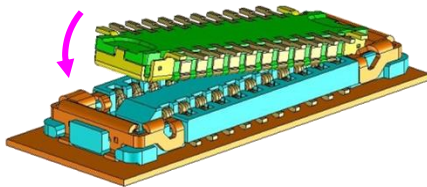

位置合わせを行った後、プラグ側とリセ側を平行にしてください。
Once the plug is positioned over the receptacle, move it to the parallel position.

STEP 3

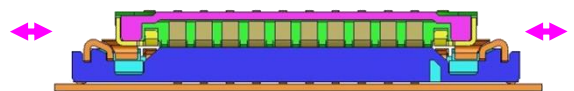
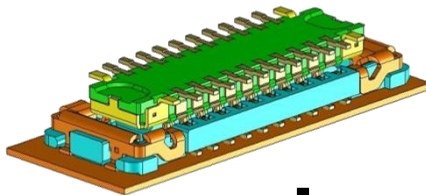

プラグ側を軽く動かし、位置合わせが正しいか確認してください。
Position the plug correct by adjusting back or forth.

Please go to sheet 11 of 14.

REVISE ON PC ONLY		TITLE:			
A	SEE SHEET 1 OF 14	0.35 BB CONN. HGT=0.6 SSB6 RP APPLICATION SPECIFICATION /アプリケーション仕様書			
	REV.	DESCRIPTION	THIS DOCUMENT CONTAINS INFORMATION THAT IS PROPRIETARY TO MOLEX ELECTRONIC TECHNOLOGIES, LLC AND SHOULD NOT BE USED WITHOUT WRITTEN PERMISSION		
DOCUMENT NUMBER 5050660000		DOC. TYPE PS	DOC. PART A06	CUSTOMER GENERAL	SHEET 9 OF 14

5-2-2. 短手方向に自由度がある場合 When operated in "b" direction (widthways)

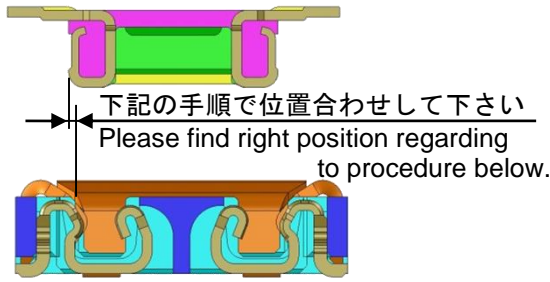

短手方向 "b" direction (widthways)

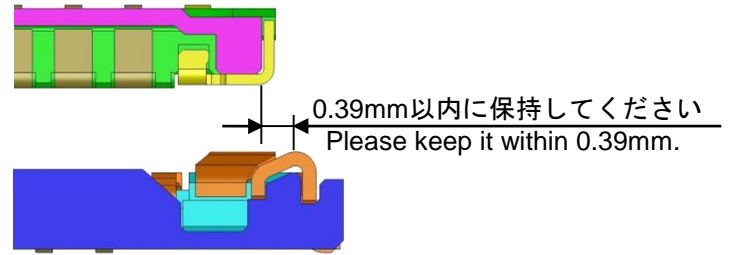

長手方向 "a" direction (lengthways)

STEP 1

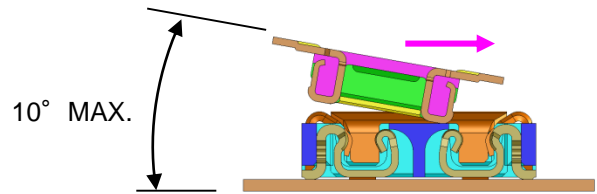
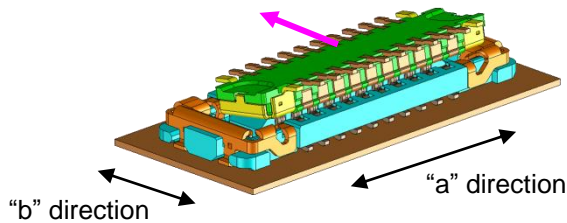

嵌合時の位置合わせは、プラグ側を少し傾けて（10°以下）行ってください。

Position for mating by inclining the plug to the receptacle approximately less than 10°.

STEP 2

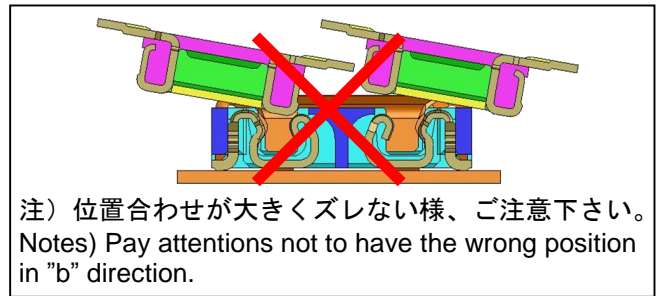
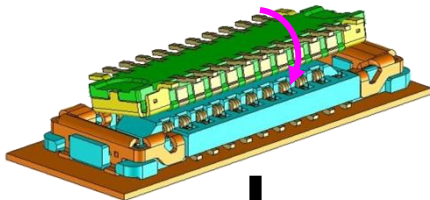

注) 位置合わせが大きくズレない様、ご注意ください。
Notes) Pay attentions not to have the wrong position in "b" direction.

STEP 3

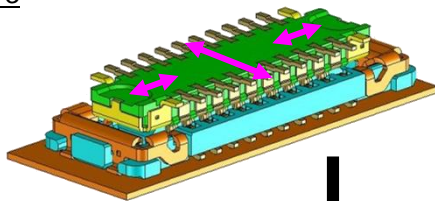

位置合わせを行った後、リセ側とプラグ側を平行にしてください。

Once the plug is positioned over the receptacle, move it to the parallel position.

Please go sheet 11 of 14.

REVISE ON PC ONLY		TITLE:			
A	SEE SHEET 1 OF 14	0.35 BB CONN. HGT=0.6 SSB6 RP APPLICATION SPECIFICATION /アプリケーション仕様書			
	REV.	DESCRIPTION	THIS DOCUMENT CONTAINS INFORMATION THAT IS PROPRIETARY TO MOLEX ELECTRONIC TECHNOLOGIES, LLC AND SHOULD NOT BE USED WITHOUT WRITTEN PERMISSION		
DOCUMENT NUMBER 5050660000		DOC. TYPE PS	DOC. PART A06	CUSTOMER GENERAL	SHEET 10 OF 14

5-3. 嵌合時 取扱注意点 CONNECTOR HANDLING WHEN MATING

コネクタ同士は平行にして嵌合してください。コネクタ同士を平行に嵌合せず、斜めにしたまま嵌合すると、ハウジング同士が干渉し、ハウジングが破損する恐れがあります。

Please **DO NOT** apply force while mating the receptacle or plug at an angle in the “a” direction (lengthways). It may cause damage to the connector.

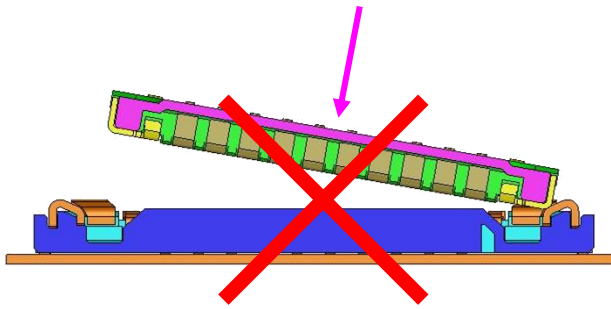

コネクタ斜め嵌合
Mating with angle (Wrong Handling)

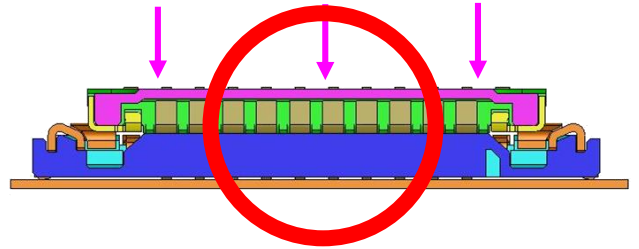

コネクタ平行嵌合
Mating with Parallel (Correct Handling)

当該製品は既存製品に比べ小型化した製品であり、コネクタ単体の強度（ハウジング強度）は低下しています。嵌合（挿入）の際は、コネクタ端部片側だけの押し込みではなく、全体を平行に押し込んで頂けます様、お願い致します。FPC補強板の強度が十分でない場合、コネクタ端部のみを押し込むと、コネクタが割れる、または、未嵌合の可能性があります。

This product is downsized comparing with the current products and needs to be handled more carefully. When mating (inserting), **DO NOT** push the only end of connector but the whole connector in parallel with the plug. When pushed only the end of connector, it may cause damage to the connector or non-mating.

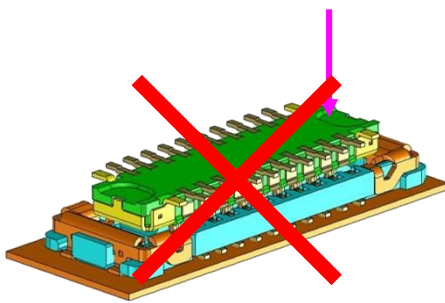

コネクタ端部だけの押し込み
Pushing Only End (Wrong Handling)

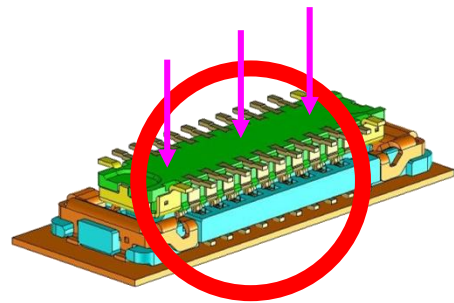

コネクタ全体 平行押し込み
Pushing Whole Paralleled (Correct Handling)

REVISE ON PC ONLY		TITLE: 0.35 BB CONN. HGT=0.6 SSB6 RP APPLICATION SPECIFICATION /アプリケーション仕様書			
A	SEE SHEET 1 OF 14				
REV.	DESCRIPTION	THIS DOCUMENT CONTAINS INFORMATION THAT IS PROPRIETARY TO MOLEX ELECTRONIC TECHNOLOGIES, LLC AND SHOULD NOT BE USED WITHOUT WRITTEN PERMISSION			
DOCUMENT NUMBER 5050660000		DOC. TYPE PS	DOC. PART A06	CUSTOMER GENERAL	SHEET 11 OF 14

【6. 抜去に関して UN-MATING OPERATION】

6-1. 抜去方法 HOW TO WITHDRAW

極力嵌合軸に沿って平行に抜去して頂くか、左右に少しずつ振りながら抜去して頂けます様、宜しくお願い致します。

The receptacle shall be released from the plug paralleled to the mated axis or by moving the plug slowly.

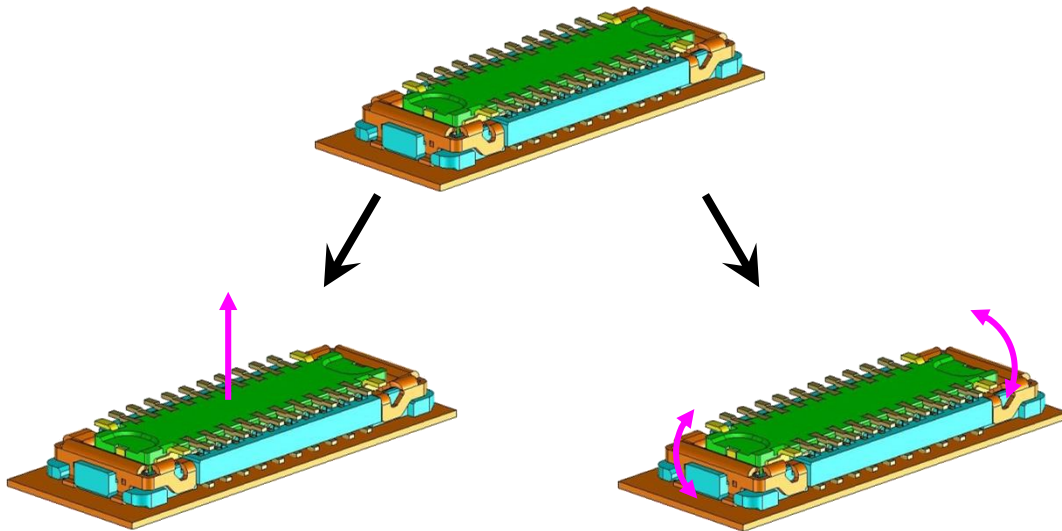

嵌合軸に沿って平行に抜く
Releasing the receptacle paralleled to the mated axis.

左右に少しずつ振りながら抜く（長手方向）
Releasing the receptacle by moving slowly in “a” direction. (lengthways)

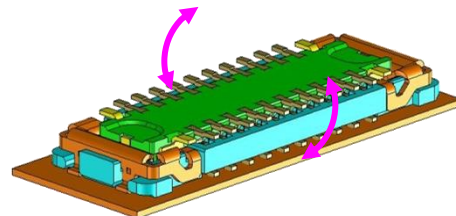

左右に少しずつ振りながら抜く（短手方向）
Releasing the receptacle by moving slowly in “b” direction. (widthways)

REVISE ON PC ONLY		TITLE:			
A	SEE SHEET 1 OF 14	0.35 BB CONN. HGT=0.6 SSB6 RP APPLICATION SPECIFICATION /アプリケーション仕様書			
	REV.	DESCRIPTION	THIS DOCUMENT CONTAINS INFORMATION THAT IS PROPRIETARY TO MOLEX ELECTRONIC TECHNOLOGIES, LLC AND SHOULD NOT BE USED WITHOUT WRITTEN PERMISSION		
DOCUMENT NUMBER 5050660000		DOC. TYPE PS	DOC. PART A06	CUSTOMER GENERAL	SHEET 12 OF 14
EN-127(2015-12)					

6-2. 抜去時 取扱注意点 CONNECTOR HANDLING WHEN WITHDRAWING

当該製品は既存製品に比べ小型化されている製品であり、コネクタ単体の強度（ハウジング強度）は低下しています。抜去の際に、過度のこじり抜去（斜め抜去）を行うとコネクタが破壊する可能性があります。

This product is downsized comparing with the current products and needs to be handled more carefully. When un-mating (withdrawing), **DO NOT** twist the receptacle to release. It may cause damage to the connector.

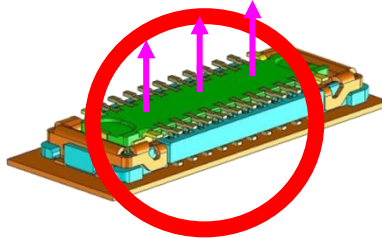

平行抜去

Releasing the receptacle paralleled to the mated axis.

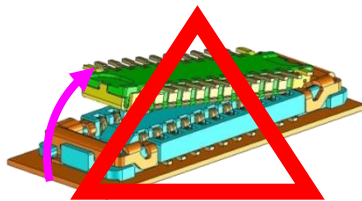

長手方向の斜め抜去

Slant releasing in "a" direction. (lengthways)

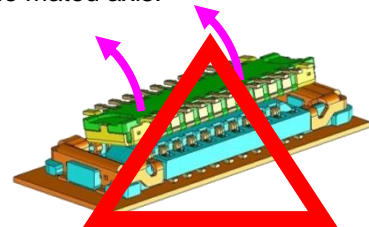

短手方向の斜め抜去

Slant releasing in "b" direction. (widthways)

尚、長手方向の斜め抜去と短手方向の斜め抜去では以下のメリット・デメリットがあります。
Merit and demerit for slant releasing are below.

	長手方向斜め抜去 Slant releasing in "a" direction (lengthways)	短手方向斜め抜去 Slant releasing in "b" direction (widthways)
メリット Merit	<ul style="list-style-type: none"> 端子変形が起こりにくい Not easily cause the damage to the terminals. 抜去力が低い Hard to be withdrawn. 	<ul style="list-style-type: none"> 特にありません None
デメリット Demerit	<ul style="list-style-type: none"> 多極の場合、コネクタが折れる可能性がある Multiple connector can be damaged in its plug. プラグ補強金具が剥離する可能性がある Fitting nails can be off out of the plug. (補強板厚み/材質を検討し、強度UPが必要) (The reinforcement board is required to be designed for enough strength with its thickness and its material) 	<ul style="list-style-type: none"> 端子捲れが発生する可能性がある The terminals on the receptacle can be damaged 端子が変形し不導通になる可能性がある The continuity defect can be caused by the damage to the terminals. ハウジングが割れる可能性がある The housing can be damaged.

REVISE ON PC ONLY	
A	SEE SHEET 1 OF 14
REV.	DESCRIPTION

TITLE: 0.35 BB CONN. HGT=0.6 SSB6 RP APPLICATION SPECIFICATION /アプリケーション仕様書	
THIS DOCUMENT CONTAINS INFORMATION THAT IS PROPRIETARY TO MOLEX ELECTRONIC TECHNOLOGIES, LLC AND SHOULD NOT BE USED WITHOUT WRITTEN PERMISSION	

DOCUMENT NUMBER 5050660000	DOC. TYPE PS	DOC. PART A06	CUSTOMER GENERAL	SHEET 13 OF 14
-------------------------------	-----------------	------------------	---------------------	-------------------

