

Distributed by:

JAMECO[®]
ELECTRONICS

www.Jameco.com ♦ 1-800-831-4242

The content and copyrights of the attached
material are the property of its owner.

Jameco Part Number 1972346

1.25mm (.049") Pitch PicoBlade™ Wire-To-Wire Crimp Terminal 50125/50133 Male

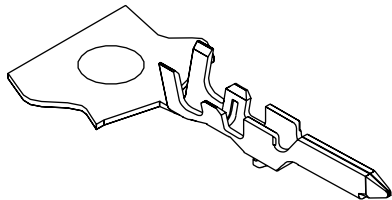

Order No.	Wire Range AWG	Packaging	Lead-free
50125-8000	26 to 28	Reel	Yes
50125-8100		Bag	
50133-8000	28 to 32	Reel	
50133-8100		Bag	

Features and Benefits

- Locking tang for secure housing retention

Reference Information

Packaging: Reel or bag
Use With: 51047
Mates With: 50079 and 50058
Designed In: Millimeters

Electrical

Voltage: 125V
Current: 1.0A (AWG 32—0.8A)
Contact Resistance: 20 milliohms max.
Dielectric Withstanding Voltage: 250V AC/1 min.
Insulation Resistance: 100 Megohms min.

Physical

Contact: Phosphor Bronze
Plating: Tin
Wire range: 26 to 28 AWG—50125
28 to 32 AWG—50133
Insulation Diameter: 1.0mm dia. max.
Strip Length: 1.4 to 1.9mm

1.25mm (.049") Pitch PicoBlade™ Wire-to-Wire and Wire-to-Board Receptacle 51021

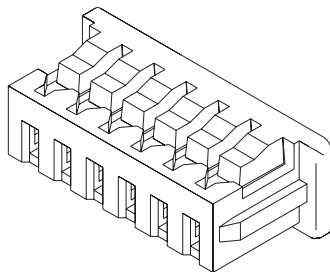

Features and Benefits

- Sizes 2 to 15 circuits
- Housing lance provides extra terminal retention
- Friction locks provide secure mating

Reference Information

Packaging: Bag
UL File No.: E29179
CSA File No.: LR19980
Use With: 50079/50058
Mates With: 53398, 53261, 53047, 53048 and 51047
Designed In: Millimeters

Electrical

Voltage: 125V
Current: 1.0A (32 AWG—0.8A)
Contact Resistance: 20 milliohms max.
Dielectric Withstanding Voltage: 250V AC/1 min.
Insulation Resistance: 100 Megohms min.

Physical

Housing: PBTP, UL 94V-0
Operating Temperature: -40 to +85°C

Circuits	Order No.
2	51021-0200
3	51021-0300
4	51021-0400
5	51021-0500
6	51021-0600
7	51021-0700
8	51021-0800

Circuits	Order No.
9	51021-0900
10	51021-1000
11	51021-1100
12	51021-1200
13	51021-1300
14	51021-1400
15	51021-1500



PRODUCT SPECIFICATION



LANGUAGE

JAPANESE
ENGLISH

【4. 性能 PERFORMANCE】

4-1. 電気的性能 Electrical Performance

項目 Item	条件 Test Condition	規格 Requirement
4-1-1 接触抵抗 Contact Resistance	コネクタを嵌合させ、開放電圧20mV 以下、 短絡電流 10mAにて測定する。 (JIS C5402 5.4) Mate connectors, measure by dry circuit, 20mV MAX., 10mA. (JIS C5402 5.4)	20 milliohm MAX.
4-1-2 絶縁抵抗 Insulation Resistance	コネクタを嵌合させ、隣接するターミナル間及びター ミナル、アース間に、DC 500V を印加し測定する。 (JIS C5402 5.2/MIL-STD-202 試験法 302) Mate connectors, apply 500V DC between adjacent terminal or ground. (JIS C5402 5.2/MIL-STD-202 Method 302)	100 Megohm MIN.
4-1-3 耐電圧 Dielectric Strength	コネクタを嵌合させ、隣接するターミナル間及びター ミナル、アース間に、AC250V (実効値)を 1分間 印加する。 (JIS C5402 5.1/MIL-STD-202 試験法 301) Mate connectors, apply 250V AC(rms) for 1 minute between adjacent terminal or ground. (JIS C5402 5.1/MIL-STD-202 Method 301)	異状なきこと No Breakdown
4-1-4 圧着部接触抵抗 Contact Resistance on Crimped Portion	ターミナルに適合電線を圧着し、開放電圧20mV以下、 短絡電流 10mA にて測定する。 Crimp the applicable wire to the terminal, measure contact resistance by dry circuit, 20mV MAX., 10mA.	5 milliohm MAX.

REVISE ON PC ONLY

TITLE:

1.25mm P.C BOARD CONNECTOR

A

SEE SHEET 1 OF 8

-LEAD FREE-

製品仕様書

THIS DOCUMENT CONTAINS INFORMATION THAT IS PROPRIETARY TO
MOLEX INC. AND SHOULD NOT BE USED WITHOUT WRITTEN PERMISSION

REV.

DESCRIPTION

DOCUMENT NUMBER

PS-51021-028

FILE NAME

PS51021028.doc

SHEET

2 OF 8

EN-37-1(019)



PRODUCT SPECIFICATION



LANGUAGE

JAPANESE
ENGLISH

4-2. 機械的性能 Mechanical Performance

項目 Item	条件 Test Condition	規格 Requirement
4-2-1 挿入力 及び抜去力 Insertion and Withdrawal Force	毎分 25±3mm の速さで挿入、抜去を行う。 Insert and withdraw connectors at the speed rate of 25±3mm/minute.	第 6 参照 Refer to paragraph 6
4-2-2 圧着部引張り強度 Crimping Pull Out Force	圧着されたターミナルを治具に固定し、電線を軸方向に毎分25±3mm の速さで引張る。 (JIS C5402 6.8) Fix the crimped terminal, apply axial pull out force on the wire at the speed rate of 25±3mm/minute. (JIS C5402 6.8)	AWG. #26 9.8 N {1.0kgf} MIN.
		AWG. #28 9.8 N {1.0kgf} MIN.
		AWG. #30 4.9 N {0.5kgf} MIN.
		AWG. #32 3.0 N {0.3kgf} MIN.
4-2-3 ターミナル挿入力 Terminal Insertion Force	圧着されたターミナルをハウジングに挿入する。 Insert the crimped terminal into the housing.	4.9 N {0.5kgf} MAX.
4-2-4 ターミナル 保持力 Terminal/Housing Retention Force	圧着されたターミナルをハウジングに装着し、電線を軸方向に毎分 25±3mm の速さで引張る。 Apply axial pull out force to the terminal assembled in the housing at the speed rate of 25±3mm/minute.	4.9 N {0.5kgf} MIN.
4-2-5 ピン保持力 Pin Retention Force	毎分25±3mm の速さで ピンを軸方向に押す。 Apply axial push force at the speed rate of 25±3mm/minute.	4.9 N {0.5kgf} MIN.

REVISE ON PC ONLY

A

SEE SHEET 1 OF 8

TITLE:

1.25mm P.C BOARD CONNECTOR

-LEAD FREE-

製品仕様書

THIS DOCUMENT CONTAINS INFORMATION THAT IS PROPRIETARY TO MOLEX INC. AND SHOULD NOT BE USED WITHOUT WRITTEN PERMISSION

REV.

DESCRIPTION

DOCUMENT NUMBER

PS-51021-028

FILE NAME

PS51021028.doc

SHEET

3 OF 8

EN-37-1(019)



PRODUCT SPECIFICATION



LANGUAGE

JAPANESE
ENGLISH

4-3. その他 Environmental Performance and Others

項目 Item		条件 Test Condition	規格 Requirement	
4-3-1	繰り返し挿抜 Repeated Insertion/ Withdrawal	1分間に10回以下の速さで挿入、抜去を30回繰り返す。 When mated up to 30 cycles repeatedly by the rate of 10 cycles/minute.	接触抵抗 Contact Resistance	40 milliohm MAX.
4-3-2	温度上昇 Temperature Rise	コネクタを嵌合させ、最大許容電流を通電し、コネクタの温度上昇分を測定する。 (UL 498) Carrying rated current load. (UL 498)	温度上昇 Temperature Rise	30°C MAX.
4-3-3	耐振動性 Vibration	DC 1mA 通電状態にて、嵌合軸を含む互いに垂直な3方向に掃引割合10~55~10Hz/分全振幅 1.5mmの振動を各2時間加える。 (JIS C60068-2-6/MIL-STD-202 試験法 201) Amplitude : 1.5mm P-P Sweep time : 10-55-10 Hz in 1 minute Duration : 2 hours in each X.Y.Z. axes (JIS C60068-2-6/MIL-STD-202 Method 201)	外 観 Appearance	異常なきこと No Damage
			接触抵抗 Contact Resistance	40 milliohm MAX.
			瞬 断 Discontinuity	1.0 microsecond MAX.
4-3-4	耐衝撃性 Shock	DC 1mA 通電状態にて、嵌合軸を含む互いに垂直な 6方向 に 490m/s ² { 50G } の衝撃を各3回 加える。 (JIS C60068-2-27/MIL-STD-202 試験法 213) 490m/s ² {50G}, 3 strokes in each X.Y.Z. axes. (JIS C60068-2-27/MIL-STD-202 Method 213)	外 観 Appearance	異常なきこと No Damage
			接触抵抗 Contact Resistance	40 milliohm MAX.
			瞬 断 Discontinuity	1.0 microsecond MAX.
4-3-5	耐熱性 Heat Resistance	コネクタを嵌合させ、85±2°Cの雰囲気中に96時間放置後取出し、1~2時間室温に放置する。 (JIS C60068-2-2/MIL-STD-202 試験法108) 85±2°C, 96 hours (JIS C60068-2-2/MIL-STD-202 Method 108)	外 観 Appearance	異常なきこと No Damage
			接触抵抗 Contact Resistance	40 milliohm MAX.

REVISE ON PC ONLY

TITLE:

1.25mm P.C BOARD CONNECTOR

A

SEE SHEET 1 OF 8

-LEAD FREE-

製品仕様書

THIS DOCUMENT CONTAINS INFORMATION THAT IS PROPRIETARY TO MOLEX INC. AND SHOULD NOT BE USED WITHOUT WRITTEN PERMISSION

REV.

DESCRIPTION

DOCUMENT NUMBER

PS-51021-028

FILE NAME

PS51021028.doc

SHEET

4 OF 8

EN-37-1(019)



PRODUCT SPECIFICATION



LANGUAGE

JAPANESE
ENGLISH

項目 Item		条件 Test Condition	規格 Requirement	
4-3-6	耐寒性 Cold Resistance	コネクタを嵌合させ、-40±3°Cの雰囲気中に96時間放置後取出し、1~2時間室温に放置する。 (JIS C60068-2-1) -40±3°C, 96 hours (JIS C60068-2-1)	外観 Appearance	異常なきこと No Damage
			接触抵抗 Contact Resistance	40 milliohm MAX.
4-3-7	耐湿性 Humidity	コネクタを嵌合させ、60±2°C、相対湿度90~95%の雰囲気中に96時間放置後取出し、1~2時間室温に放置する。 (JIS C60068-2-3/MIL-STD-202試験法103) Temperature : 60±2°C Relative Humidity : 90~95% Duration : 96 hours (JIS C60068-2-3/MIL-STD-202 Method 103)	外観 Appearance	異常なきこと No Damage
			接触抵抗 Contact Resistance	40 milliohm MAX.
			耐電圧 Dielectric Strength	4-1-3項を 満たすこと Must meet 4-1-3
			絶縁抵抗 Insulation Resistance	10 Megohm MIN.
4-3-8	温度サイクル Temperature Cycling	コネクタを嵌合させ、-55°Cに30分、+105°Cに30分 これを1サイクルとし、5サイクル繰り返す。但し、温度移行時間は5分以内とする。試験後、1~2時間室温に放置する。 (JIS C0025) 5 cycles of : a) -55°C 30minute b) +105°C 30minute (JIS C0025)	外観 Appearance	異常なきこと No Damage
			接触抵抗 Contact Resistance	40 milliohm MAX.
4-3-9	塩水噴霧 Salt Spray	コネクタを嵌合させ、35±2°Cにて、重量比5±1%の塩水を48±4時間噴霧し、試験後常温で水洗いした後、室温で乾燥させる。 (JIS C60068-2-11/MIL-STD-202 試験法 101) 48±4 hours exposure to a salt spray from the 5±1% solution at 35±2°C. (JIS C60068-2-11/MIL-STD-202 Method 101)	外観 Appearance	異常なきこと No Damage
			接触抵抗 Contact Resistance	40 milliohm MAX.

REVISE ON PC ONLY

TITLE:

1.25mm P.C BOARD CONNECTOR

A

SEE SHEET 1 OF 8

-LEAD FREE-

製品仕様書

REV.

DESCRIPTION

THIS DOCUMENT CONTAINS INFORMATION THAT IS PROPRIETARY TO MOLEX INC. AND SHOULD NOT BE USED WITHOUT WRITTEN PERMISSION

DOCUMENT NUMBER

PS-51021-028

FILE NAME

PS51021028.doc

SHEET

5 OF 8

EN-37-1(019)



PRODUCT SPECIFICATION



LANGUAGE

JAPANESE
ENGLISH

項 目 Item		条 件 Test Condition	規 格 Requirement	
4-3-10	亜硫酸ガス SO ₂ Gas	コネクタを嵌合させ、40±2°Cにて50±5ppmの亜硫酸ガス中に24時間放置する。 24 hours exposure to 50±5ppm. SO ₂ gas at 40±2°C.	外 観 Appearance	異常なきこと No Damage
			接触抵抗 Contact Resistance	40 milliohm MAX.
4-3-11	耐アンモニア性 NH ₃ Gas	コネクタを嵌合させ、濃度 28% のアンモニア水を入れた容器中に 40分間 放置する。 (1Lに対して25mlの割合) 40 minutes exposure to NH ₃ gas evaporating from 28% Ammonia solution.	外 観 Appearance	異常なきこと No Damage
			接触抵抗 Contact Resistance	40 milliohm MAX.
4-3-12	半田付け性 Solderability	ターミナルまたはピンをフラックスに浸し、本体の取付け基準面より0.8mm迄、245±3°Cの半田に3±0.5秒浸す。 Soldering Time : 3±0.5 sec. Solder Temperature : 245±3°C	濡れ性 Solder Wetting	浸漬面積の95%以上 95% of immersed area must show no voids, pin holes.
4-3-13	半田耐熱性 Resistance to Soldering Heat	(ディップの場合) Soldering bath method ターミナルまたはピンを本体の取付け基準面より0.8mm迄、260±5°Cの半田に10±0.5秒浸す。 Soldering Time : 10±0.5 sec. Solder Temperature : 260±5°C	外 観 Appearance	端子ガタ、割れ等 異常なきこと No Damage
		(手半田時) Soldering iron method 370~400°Cの半田ゴテにて最大5秒加熱する。但し、端ピンに異常な加圧のないこと。 Solder Time : 5 sec MAX. Solder Temperature: 370~400°C However, without too much pressure to the terminal pin.		

() : 参考規格 Reference Standard
{ } : 参考単位 Reference Unit

REVISE ON PC ONLY		TITLE:	
A	SEE SHEET 1 OF 8	1.25mm P.C BOARD CONNECTOR	
	REV.	DESCRIPTION	-LEAD FREE- 製品仕様書
DOCUMENT NUMBER PS-51021-028		THIS DOCUMENT CONTAINS INFORMATION THAT IS PROPRIETARY TO MOLEX INC. AND SHOULD NOT BE USED WITHOUT WRITTEN PERMISSION	
		FILE NAME PS51021028.doc	SHEET 6 OF 8



PRODUCT SPECIFICATION



LANGUAGE

JAPANESE
ENGLISH

【5. 外観形状、寸法及び材質 PRODUCT SHAPE, DIMENSIONS AND MATERIALS】

図面参照 Refer to the drawing.

【6. 挿入力及び抜去力 INSERTION / WITHDRAWAL FORCE】

極数 No. of CKT.	単位 Unit	挿入力 (最大値) Insertion force (MAX.)			抜去力 (最小値) Withdrawal force (MIN.)		
		初回 1st	6回目 6th	30回目 30th	初回 1st	6回目 6th	30回目 30th
2	N { kgf }	19.6 { 2.0 }	17.6 { 1.8 }	15.6 { 1.6 }	2.8 { 0.28 }	2.3 { 0.23 }	1.8 { 0.18 }
3	N { kgf }	24.5 { 2.5 }	22.5 { 2.3 }	20.5 { 2.1 }	3.0 { 0.30 }	2.5 { 0.25 }	2.0 { 0.20 }
4	N { kgf }	29.4 { 3.0 }	27.4 { 2.8 }	25.4 { 2.6 }	3.3 { 0.33 }	2.8 { 0.28 }	2.3 { 0.23 }
5	N { kgf }	34.3 { 3.5 }	32.3 { 3.3 }	30.3 { 3.1 }	3.8 { 0.38 }	3.3 { 0.33 }	2.8 { 0.28 }
6	N { kgf }	39.2 { 4.0 }	37.2 { 3.8 }	35.2 { 3.6 }	4.3 { 0.43 }	3.8 { 0.38 }	3.3 { 0.33 }
7	N { kgf }	44.1 { 4.5 }	42.1 { 4.3 }	40.1 { 4.1 }	4.7 { 0.48 }	4.3 { 0.43 }	3.8 { 0.38 }
8	N { kgf }	49.0 { 5.0 }	47.0 { 4.8 }	45.0 { 4.6 }	5.2 { 0.53 }	4.7 { 0.48 }	4.3 { 0.43 }
9	N { kgf }	53.9 { 5.5 }	51.9 { 5.3 }	49.9 { 5.1 }	5.5 { 0.56 }	5.0 { 0.51 }	4.5 { 0.46 }
10	N { kgf }	58.8 { 6.0 }	56.8 { 5.8 }	54.8 { 5.6 }	5.8 { 0.59 }	5.3 { 0.54 }	4.8 { 0.49 }
11	N { kgf }	63.7 { 6.5 }	61.7 { 6.3 }	59.7 { 6.1 }	6.1 { 0.62 }	5.6 { 0.57 }	5.1 { 0.52 }
12	N { kgf }	68.6 { 7.0 }	66.6 { 6.8 }	64.6 { 6.6 }	6.4 { 0.65 }	5.9 { 0.60 }	5.4 { 0.55 }
13	N { kgf }	73.5 { 7.5 }	71.5 { 7.3 }	69.5 { 7.1 }	6.7 { 0.68 }	6.2 { 0.63 }	5.7 { 0.58 }
14	N { kgf }	78.4 { 8.0 }	76.4 { 7.8 }	74.4 { 7.6 }	7.0 { 0.71 }	6.5 { 0.66 }	6.0 { 0.61 }
15	N { kgf }	83.3 { 8.5 }	81.3 { 8.3 }	79.3 { 8.1 }	7.3 { 0.74 }	6.8 { 0.69 }	6.3 { 0.64 }

REVISE ON PC ONLY

TITLE:

1.25mm P.C BOARD CONNECTOR

A

SEE SHEET 1 OF 8

-LEAD FREE-

製品仕様書

THIS DOCUMENT CONTAINS INFORMATION THAT IS PROPRIETARY TO
MOLEX INC. AND SHOULD NOT BE USED WITHOUT WRITTEN PERMISSION

REV.

DESCRIPTION

DOCUMENT NUMBER

PS-51021-028

FILE NAME

PS51021028.doc

SHEET

7 OF 8

EN-37-1(019)

DWG. NO.
SD-51021-**0*

トレードマーク
TRADE MARK

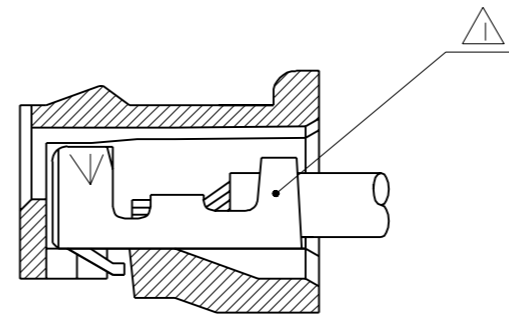
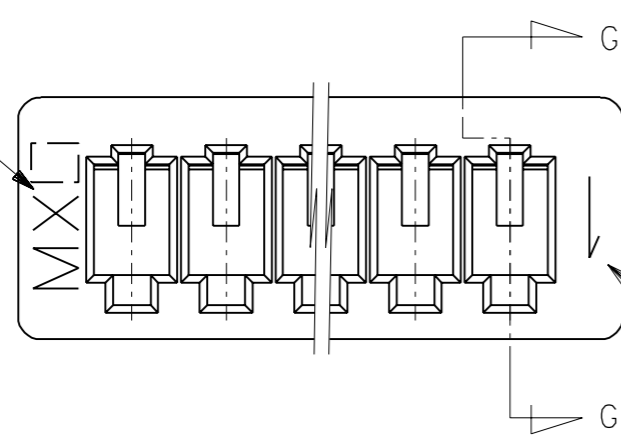

注記 NOTES

- △1 適合ターミナル : 50058, 50079 シリーズ
APPLICABLE TERMINAL : 50058, 50079 SERIES
- 2 嵌合相手 : 53047, 53048, 53261, 53398 シリーズ
MATE WITH : 53047, 53048, 53261, 53398 SERIES
- △3 ロックは、2, 3極は1ヶ, 4極以上は2ヶとする。
LOCKING WINDOW : ONE PLACE FOR 2 & 3 CKT.
AND TWO PLACES FOR MORE THAN 3 CKT.
- △4 ウエハーの色 COLOR OF WAFER
ENG. NO. の下1桁に対応する。
CORRESPONDS TO LAST DIGIT OF ENG.NO.
黒 BLACK ; 51021-**01

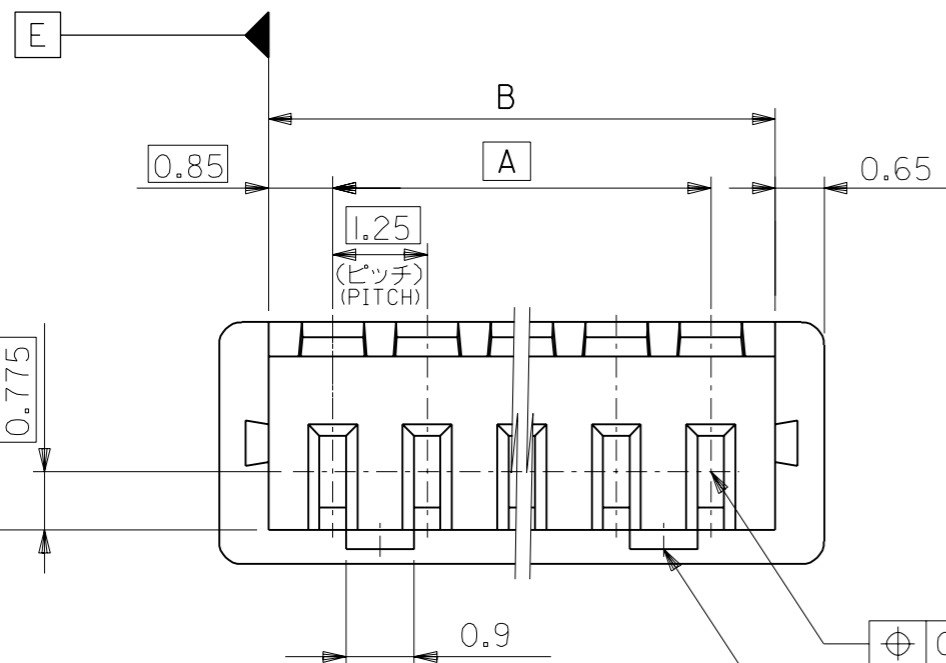
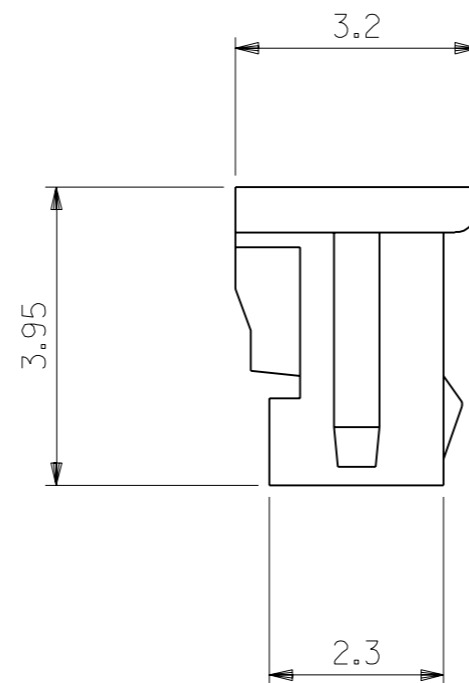
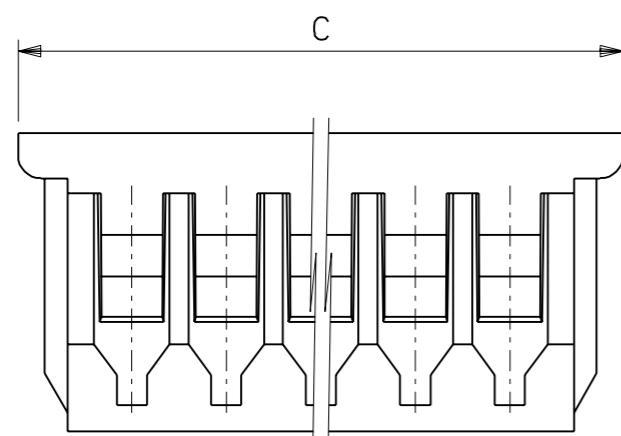

20.5	19.2	17.5	51021-150*	15
19.25	17.95	16.25	-140*	14
18	16.7	15	-130*	13
16.75	15.45	13.75	-120*	12
15.5	14.2	12.5	-110*	11
14.25	12.95	11.25	-100*	10
13	11.7	10	-090*	9
11.75	10.45	8.75	-080*	8
10.5	9.2	7.5	-070*	7
9.25	7.95	6.25	-060*	6
8	6.7	5	-050*	5
6.75	5.45	3.75	-040*	4
5.5	4.2	2.5	-030*	3
4.25	2.95	1.25	51021-020*	2
C	B	A	ENG.NO. △4	極数 CKTS.

材料 MATERIAL	PBTP UL94V-0
仕上げ FINISH	—H—
適用電線範囲 WIRE RANGE	—H—
被覆外径 INS. RANGE	—H—
DRAWN BY '95/5/31 T.ASAKAWA	CHK'D BY '95/5/31 Y.M.H.HIRAMOTO
APP'D BY '95/5/31 M.FUKUSHIMA	尺度 SCALE 10 : 1

molex MOLEX-JAPAN CO.,LTD.
日本モレックス株式会社

REVISE ONLY ON CAD SYSTEM

TITLE 名称
1.25 WIRE TO BOARD CONN.
RECEPTACLE HOUSING
(DYED COLOR)

DWG. NO.
SD-51021-**0*

REV
0

角度 ANGLE	±3°
30 以上 OVER	±0.3
10 以上 30 未満 OVER UNDER	±0.25
10 未満 UNDER	±0.2
一般公差 GENERAL TOLERANCES	記号 LTR
新規作成 RELEASED (J50396)	T.A. H.H.
変更内容 REVISION RECORD	DR. CHK.
	日付 DATE

DIMENSIONS IN METRIC DO NOT SCALE DRAWING

21.5.2015

DWG. NO.
SD-51021-**-00

トレードマーク
TRADE MARK

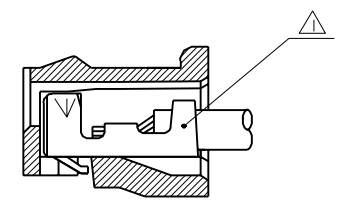
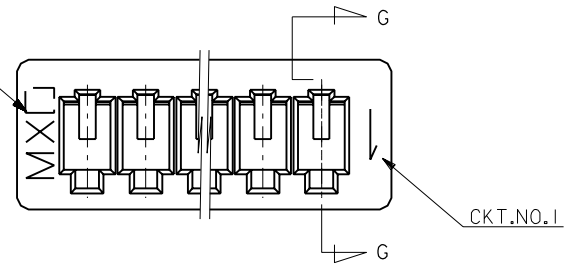

SECT. G-G

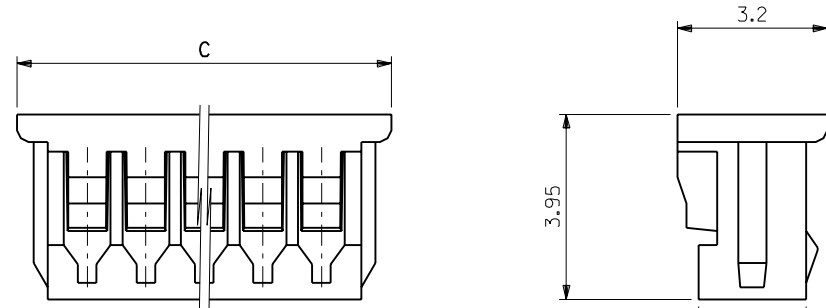

注記 NOTES

- △ 適合ターミナル : 50058, 50079 シリーズ
APPLICABLE TERMINAL : 50058, 50079 SERIES
- 2 嵌合相手 : 53047, 53048, 53261, 53398 シリーズ
MATE WITH : 53047, 53048, 53261, 53398 SERIES
- △ ロックは、2, 3極は1ヶ, 4極以上は2ヶとする。
LOCKING WINDOW : ONE PLACE FOR 2 & 3 CKT.
AND TWO PLACES FOR MORE THAN 3 CKT.

20.5	19.2	17.5	51021-1500	15
19.25	17.95	16.25	-1400	14
18	16.7	15	-1300	13
16.75	15.45	13.75	-1200	12
15.5	14.2	12.5	-1100	11
14.25	12.95	11.25	-1000	10
13	11.7	10	-0900	9
11.75	10.45	8.75	-0800	8
10.5	9.2	7.5	-0700	7
9.25	7.95	6.25	-0600	6
8	6.7	5	-0500	5
6.75	5.45	3.75	-0400	4
5.5	4.2	2.5	-0300	3
4.25	2.95	1.25	51021-0200	2
C	B	A	ENG.NO.	種数 CKTS.

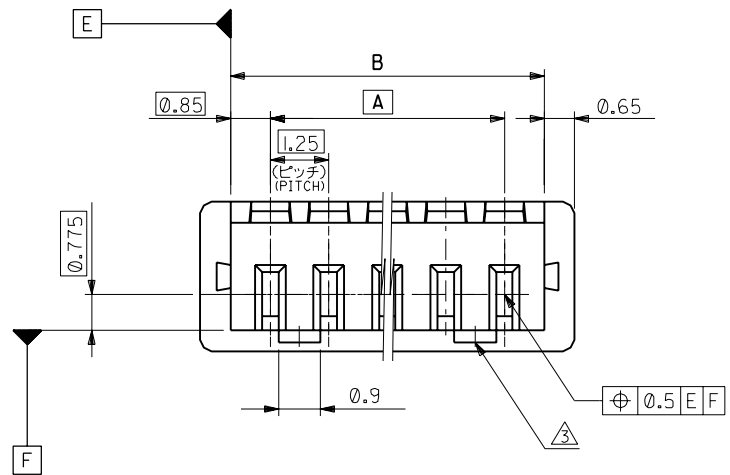

材料 MATERIAL		PBTP UL94V-0		molex MOLEX-JAPAN CO.,LTD. 日本モレックス株式会社	
仕上げ FINISH		—H—		REVISE ONLY ON CAD SYSTEM	
適用電線範囲 WIRE RANGE		—H—		TITLE 名称	
被覆外径 INS. RANGE		—H—		1.25 WIRE TO BOARD CONN. RECEPTACLE HOUSING	
DRAWN BY '93/6/1 K.TOJO		CHK'D BY '93/6/1 H.HIRAMOTO		DWG. NO.	
APP'D BY '93/6/1 M.FUKUSHIMA		DR. DATE		SD-51021-**-00	
SCALE 10 : 1		REV		D	
角度 ANGLE		±3°			
30 以上 OVER		+0.3			
10 以上 30 未満 UNDER		+0.25			
10 未満 UNDER		+0.2			
一般公差 GENERAL TOLERANCES		記号 LTR		変更内容 REVISION RECORD	
		D		変更及び再作図 REVISED & REDRAWN (030522)	
		K.T. H.H.		DR. DATE	
		'93/6/1			

10 9 8 7 6 5 4 3 2 1

F

E

D

C

B

A

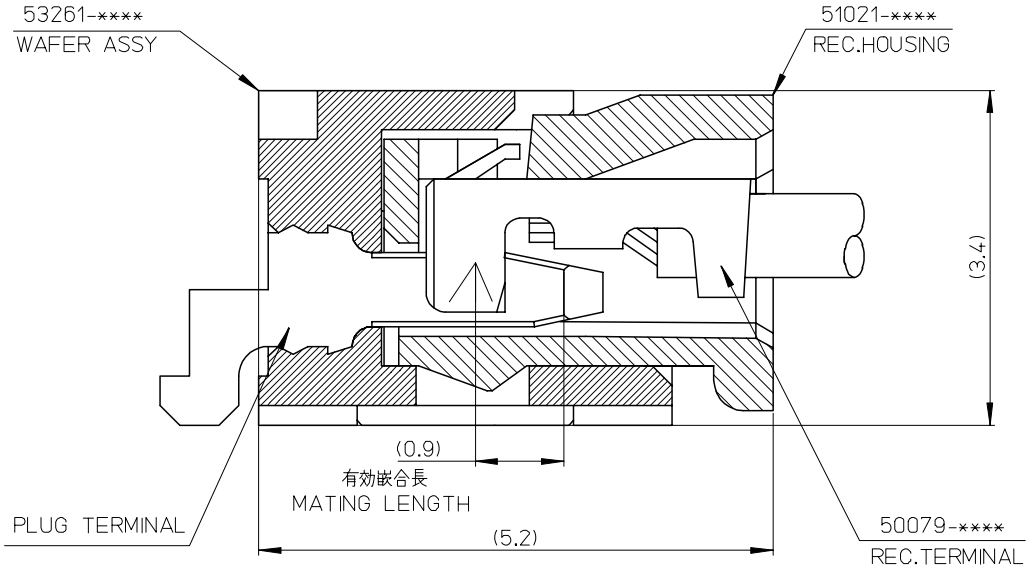

53261-****	WAFER ASSY	MODEL NO./MATERIAL NO.
50079-****	TERMINAL	
51021-****	HOUSING	

RELEASED EC NO: J2006-2426 DRWN: A0YAGI 2006/02/02 CHKD: YMAEDA 2006/02/03 APPR: NUKITA 2006/02/07	GENERAL TOLERANCES (UNLESS SPECIFIED)		DIMENSION STYLE MM ONLY		SCALE ---	DESIGN UNITS METRIC	THIRD ANGLE PROJECTION	
	10 UNDER	± ---	DRAWN BY Y. A0YAGI	DATE 2006/01/30	TITLE 1.25 W-TO-B CONN. 51021,53261 MATING CROSS SECTION			
	10 OVER 30 UNDER	± ---	CHECKED BY Y. MAEDA	DATE 2006/01/30	MOLEX INCORPORATED			
	30 OVER	± ---	APPROVED BY N. UKITA	DATE 2006/01/30	DOCUMENT NO. SD-51021-002			
	ANGULAR	± --- °	MATERIAL NO. SEE CHART		SHEET NO. 1 OF 1			
0	DRAFT WHERE APPLICABLE MUST REMAIN WITHIN DIMENSIONS		SIZE A3		THIS DRAWING CONTAINS INFORMATION THAT IS PROPRIETARY TO MOLEX INCORPORATED AND SHOULD NOT BE USED WITHOUT WRITTEN PERMISSION			

9

8

7

6

5

4

3

2