



Serial ATA\* –  
The Next Wave Of Storage  
Interconnect Applications



# Serial ATA Board-to-Board and Cable-to-Board Solutions To Meet All Storage Applications

Changing applications in digital consumer technology are re-shaping the storage application landscape. Moving beyond traditional desktop and network storage applications, Serial ATA is quickly becoming an integral part of consumer electronic products with integrated hard disk drives.

With applications that include HDD-DVD recorders, home servers, multimedia hubs, LCD TVs digital jukeboxes, HDD-enabled game consoles, set-top boxes with personal video recorders, audio players and audiovisual devices for the automotive industry, insuring a secure connection is a primary concern.

To address this concern Molex has incorporated a stainless metal latch into the design of its Serial ATA cable receptacles. When mated with a latch-designed plug, the metal latch catches the latch window on the plug side, thus providing a secure locking action.

Molex's global leadership and expertise in the design and manufacture of Serial ATA interconnect systems have allowed them to provide innovative solutions to the world's leading hard disk drive makers. Their ability to offer prompt time-to-market and low cost strategies makes Molex a reliable and innovative solution partner.

For more information on all Molex products, please visit our website at [www.molex.com](http://www.molex.com).

## Desktop Computing

- Hard Disk Drive
- Motherboard
- Power Supply
- Adapters
- Controller Boards
- Data Protection
- Workstation

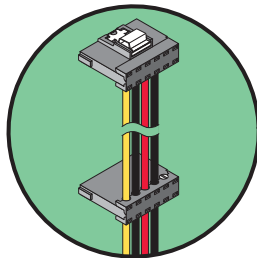

67926-0021  
67926-0011  
IDT With Metal  
Latch Available

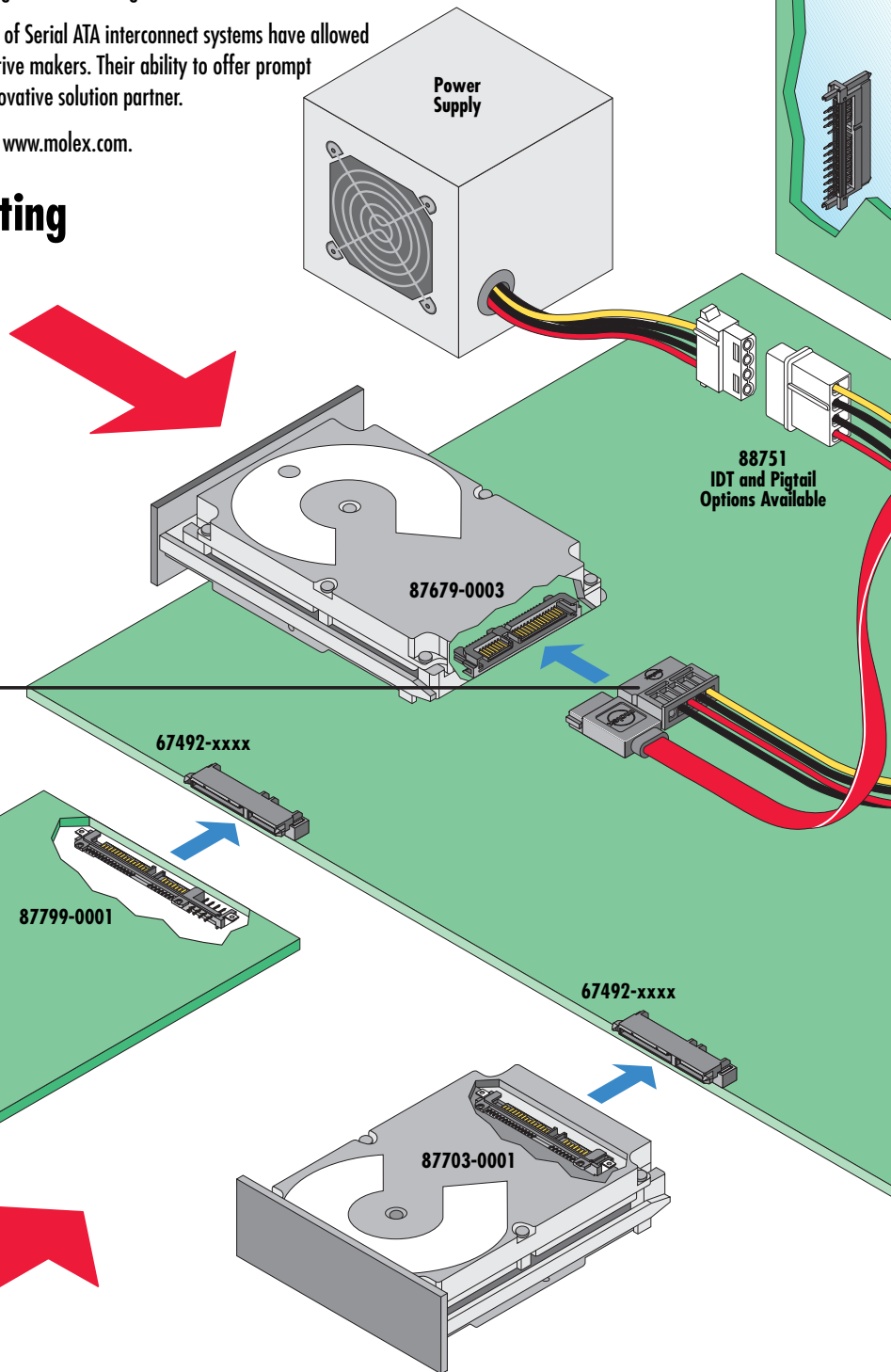

## Mobile Computing

- Notebook PC
- Sub-Notebook PC
- Media PC
- Multimedia Peripherals

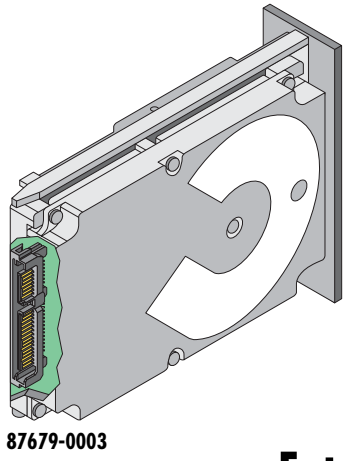
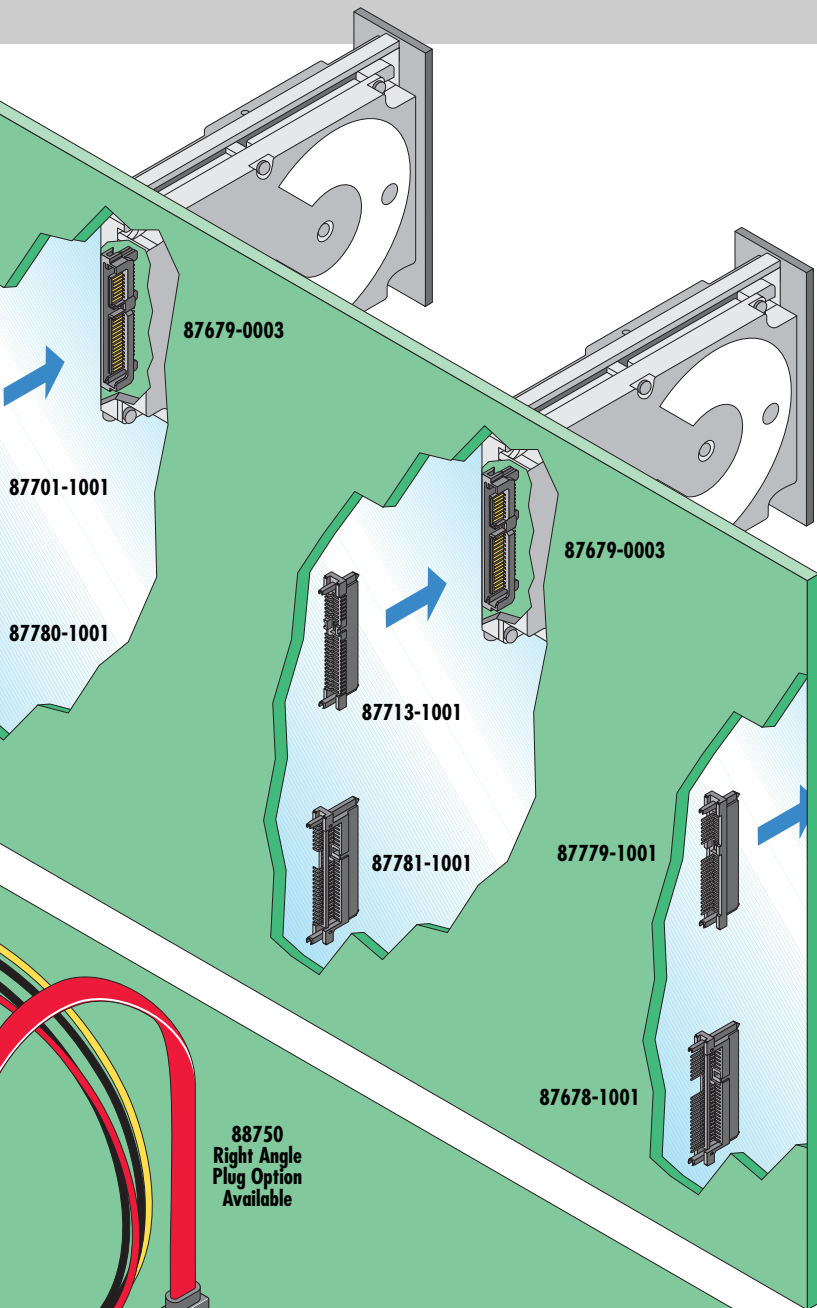

**Enterprise Computing**

- Mid Range Servers
- Network Storage
- RAID Storage
- Backplane
- Internet Services

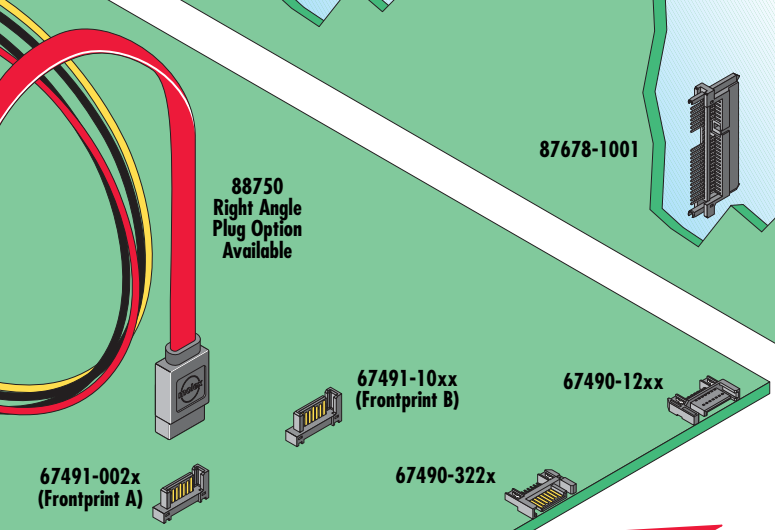

**Emerging Trends**

- Set-Top Box
- Digital Audio
- Automotive – Navigation
- Brown Goods
- Optical Drives
- HDTV Home Theatre
- Games – 3D Video

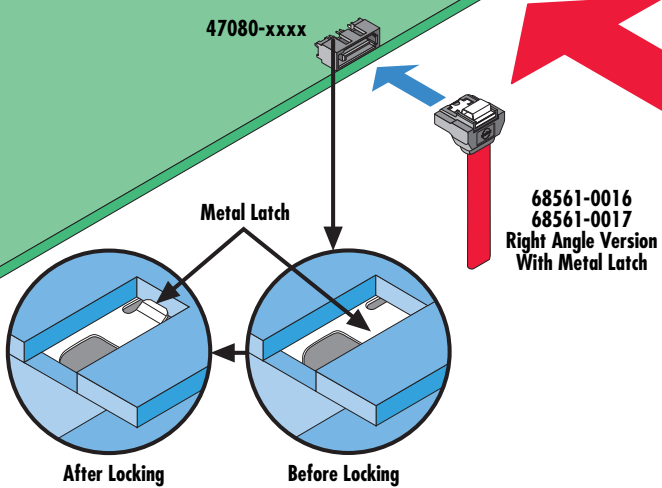
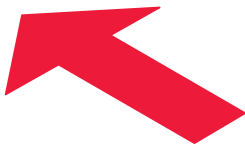

\*Serial ATA is a trademark of the Serial ATA<sup>sm</sup> Trade Association

**EXTERNAL SATA RECEPTACLE**

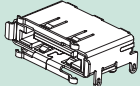
	Description	Lead-Free Order No.	Features						
			Plating	Housing Color	PC Tail Length	Peg Type And Length	Packaging		Mates With
	External SATA Receptacle, SMT, Metal Shell	47082-0000	Gold Flash	Black	NA	Flat Metal Peg	Embossed Tape On Reel	With Mylar	External Serial ATA Plug
		47082-2000	0.76µm/30µ" Gold						
		47082-1000	0.38µm/15µ" Gold						

**SIGNAL PLUGS**

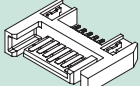
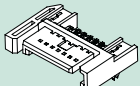
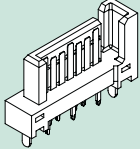
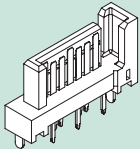
	Description	Lead-Free Order No.	Features							
			Plating	Housing Color	PC Tail Length	Peg Type And Length	Packaging		Mates With	
	Right Angle SMT Signal Plug (Reverse Mount)	67490-3220	Gold Flash	Black	NA	Flat Metal Peg	Tray		Cable Assemblies 88750-5310 8750-5318 88750-5400 88750-5410  Signal Cable Assemblies 67489-100y 67489-800y	
		67490-3221	0.76µm/30µ" Gold							
		67490-3225	0.38µm/15µ" Gold							
	Right Angle SMT Signal Plug (Standard Mount)	67490-1220	Gold Flash				Embossed Tape On Reel			With Mylar
		67490-1221	0.76µm/30µ" Gold							
		67490-1225	0.38µm/15µ" Gold							
		67490-1230	Gold Flash							
		67490-1231	0.76µm/30µ" Gold				Tube			
		67490-1235	0.38µm/15µ" Gold							
		67490-1240	Gold Flash							
		67490-1241	0.76µm/30µ" Gold							
	88750-5418 Vertical Through Hole Signal Plug (Footprint A)	67491-0020	Gold Flash	2.05mm	Tray					
		67491-0021	0.76µm/30µ" Gold							
		67491-0022	0.38µm/15µ" Gold							
		67491-0025	Gold Flash							
		67491-0026	0.76µm/30µ" Gold							
	Vertical Through Hole Signal Plug (Footprint B)	67491-1030	Gold Flash	2.35mm	Tray					
		67491-1031	0.76µm/30µ" Gold							
		67491-1032	0.38µm/15µ" Gold							
		67491-1035	Gold Flash							
		67491-1036	0.76µm/30µ" Gold	3.00mm						
		67491-1037	0.38µm/15µ" Gold							
		67491-1038	Gold Flash							
		67491-1039	0.76µm/30µ" Gold							
		67491-1040	0.38µm/15µ" Gold							

### SIGNAL PLUGS

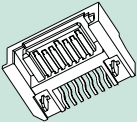
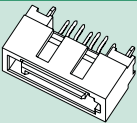
	Description	Lead-Free Order No.	Features						
			Plating	Housing Color	PC Tail Length	Peg Type And Length	Packaging	Mates With	
	Right Angle SMT Plug With Peg, Latch Type	47080-4001	Gold Flash	Black	NA	Flat Metal Peg 2.60mm	Embossed Tape On Reel	With Mylar	67489 88750-5310 88750-5318 88750-5410 88750-5418
		47080-4002	0.76µm/30µ" Gold						
		47080-4005	0.38µm/15µ" Gold						
		47080-5001	Gold Flash	Natural					
		47080-5002	0.76µm/30µ" Gold						
		47080-5005	0.38µm/15µ" Gold						
		47080-6001	Gold Flash	Blue					
		47080-6002	0.76µm/30µ" Gold						
		47080-6005	0.38µm/15µ" Gold						
	Vertical Through Hole Signal Plug, Latch Type	47155-4001	Gold Flash	Black	2.10mm PC Tail	Flat Metal Peg 2.65mm	Tray		
		47155-4031		Blue					
		47155-4041		Natural					
		67800-5001		Black					NA
67800-5002	0.76µm/30µ" Gold								
67800-5005	0.38µm/15µ" Gold								
67800-5021	Gold Flash	Round Peg 3.45mm							
67800-5022	0.76µm/30µ" Gold								
67800-5025	0.38µm/15µ" Gold								

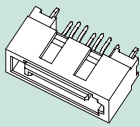
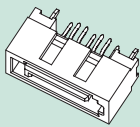
SIGNAL PLUGS												
	Description	Lead-Free Order No.	Features									
			Plating	Housing Color	PC Tail Length	Peg Type And Length	Packaging	Mates With				
	Vertical Through Hole Signal Plug, Latch Type (Footprint A)	67800-8X0Y	For plating information please see the plating key below	Black	2.45mm	Flat Metal Peg	Tray	Cable Assemblies 68561-0014 68561-0015 68561-0016 68561-0017				
		67800-8X1Y			2.85mm							
		67800-8X2Y			3.25mm							
		67800-8X3Y			2.45mm							
		67800-8X7Y			2.85mm							
		67800-8X8Y			3.25mm							
		67800-8X4Y		2.45mm								
		67800-8X5Y		2.85mm								
		67800-8X6Y		3.25mm								
	Vertical Through Hole Signal Plug, Latch Type (Footprint B)	67800-7X0Y		For plating information please see the plating key below	Black				2.45mm	Flat Metal Peg	Tray	Signal Cable Receptacles 67489-000y 67489-200y 67489-700y 67489-200y
		67800-7X1Y							2.85mm			
		67800-7X2Y							3.25mm			
		67800-7X3Y							2.45mm			
		67800-7X7Y							2.85mm			
		67800-7X8Y							3.25mm			
		67800-7X4Y			2.45mm							
		67800-7X5Y			2.85mm							
		67800-7X6Y			3.25mm							

Housing Material    Replace X With:

0 = Thermoplastic

1 = High Temperature Thermoplastic

Contact Plating    Replace Y With:







1 = Gold Flash

2 = 0.76µm/30µ" Gold

5 = 0.38µm/15µ" Gold

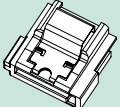

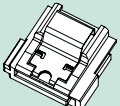
**SIGNAL CABLE RECEPTACLES**

	Description	Lead-Free Order No.	Features			
			Plating	Locking	Packaging	Mates With
	Right Angle Signal Receptacle	67489-1001	Gold Flash	Friction Locking	Tray	67490 67491
		67489-1002	0.76µm/30µ" Gold			
		67489-1005	0.38µm/15µ" Gold			
	Vertical Signal Receptacle	67489-8001	Gold Flash			
		67489-8002	0.76µm/30µ" Gold			
		67489-8005	0.38µm/15µ" Gold			
 	Right Angle Signal Receptacle With Metal Latch	67489-0001	Gold Flash	Metal Latch	Tray	47080 47155 67800
		67489-0002	0.76µm/30µ" Gold			
		67489-0005	0.38µm/15µ" Gold			
		67489-2001	Gold Flash	Metal Latch And Friction Locking		
		67489-2002	0.76µm/30µ" Gold			
		67489-2005	0.38µm/15µ" Gold			
 	Vertical Signal Receptacle With Metal Latch	67489-9001	Gold Flash	Metal Latch	Tray	
		67489-9002	0.76µm/30µ" Gold			
		67489-9005	0.38µm/15µ" Gold			
		67489-7001	Gold Flash	Metal Latch And Friction Locking		
		67489-7002	0.76µm/30µ" Gold			
		67489-7005	0.38µm/15µ" Gold			

**POWER CONNECTORS**

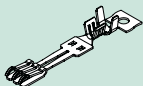
	Description	Lead-Free Order No.	Features				
			Plating	Reel Direction	Wire Gauge	Packaging	Mates With
	Crimp Power Terminal	67581-0000	Gold Flash	Clockwise	18 AWG	Reel	67582
		67581-0001	0.76µm/30µ" Gold	Clockwise			
		67581-0002	0.38µm/15µ" Gold	Clockwise			
		67581-0010	Gold Flash	Anti-Clockwise			
		67581-0011	0.76µm/30µ" Gold	Anti-Clockwise			
		67581-0012	0.38µm/15µ" Gold	Anti-Clockwise			
		47128-1000	Gold Flash	Anti-Clockwise	18 AWG 22 AWG		
		47128-1001	0.76µm/30µ" Gold	Anti-Clockwise			
		47128-1002	0.38µm/15µ" Gold	Anti-Clockwise			
		47128-1009	Unplated	Anti-Clockwise			

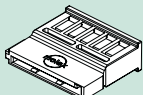
	Description	Lead-Free Order No.	Housing Material	Packaging	Mates With
	Crimp Power Housing	67582-0000	Thermoplastic	Bag	67581 47128

**POWER CONNECTORS**

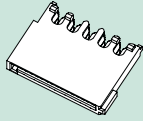
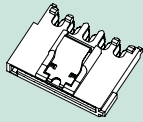
	Description	Lead-Free Order No.	Features			
			Plating	Locking	Packaging	Mates With
 Without Latch   With Latch	IDT Power Receptacle	67926-0001	Gold Flash	Metal Latch	Tray	87679 Use With: 67926-0040 67926-0041
		67926-0002	0.76µm/30µ" Gold			
		67926-0005	0.38µm/15µ" Gold			
		67926-0011	Gold Flash	Friction Locking		
		67926-0012	0.76µm/30µ" Gold			
		67926-0015	0.38µm/15µ" Gold			
		67926-0021	Gold Flash	Metal Latch And Friction Locking		
		67926-0022	0.76µm/30µ" Gold			
67926-0025	0.38µm/15µ" Gold					

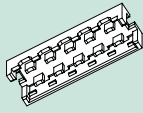
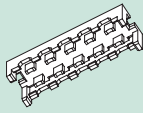
	Description	Lead-Free Order No.	Termination Style	Unmated Height	Packaging	Mates With
	Feed-To Cover For IDT Power Receptacle	67926-0040	Feed-To	4.99mm (.198")	Bag	67926-000* 67926-001*
	Feed-Through Cover For IDT Power Receptacle	67926-0041	Feed-Through	4.90mm (.193")		

**COMBO PLUGS**

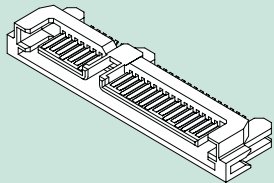
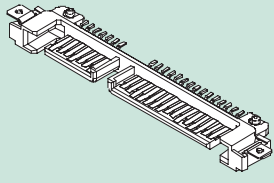
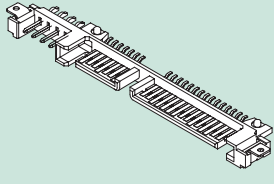
	Description	Lead-Free Order No.	Features					
						Mates With		
			Plating	Locking	Packaging	Board-to-Board	Cable-to-Board	
						Combo Receptacles	Signal	Power
	Device Plug With Latching Straddle Mount	87679-0003	Gold Flash	Metal Latch And Friction Locking	Tray	67492 87678 87701 87713 87779 87780 87781 47162 47018	67489 88750 88762	88751 88757 88761
	Device Plug SMT Without Jumper	87703-0001		Friction Locking				
	Device Plug, SMT With Jumper	87799-0001						

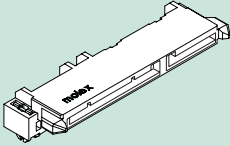

**COMBO RECEPTACLES**

	Description	Lead-Free Order No.	Features				
			Plating	Housing Color	Unmated Height	Packaging	Mates With
	Right Angle SMT Receptacle	67492-1120	Gold Flash	Black	3.55mm (.140")	Tray	<u>Combo Plugs</u> 87679 87703 87799
		67492-1121	0.76µm/30µ" Gold				
		67492-1122	0.38µm/15µ" Gold				
		67492-1123	Gold Flash Over Palladium-Nickel				
		67492-1320	Gold Flash		5.25mm (.207")		
		67492-1321	0.76µm/30µ" Gold				
		67492-1322	0.38µm/15µ" Gold				
		67492-1323	Gold Flash Over Palladium-Nickel				
		67492-1420	Gold Flash		5.90mm (.232")		
		67492-1421	0.76µm/30µ" Gold				
		67492-1422	0.38µm/15µ" Gold				
		67492-1423	Gold Flash Over Palladium-Nickel				
		67492-9220	Gold Flash		6.74mm (.285")		
		67492-9221	0.76µm/30µ" Gold				
		67492-9222	0.38µm/15µ" Gold				
67492-9223	Gold Flash Over Palladium-Nickel						

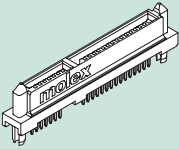
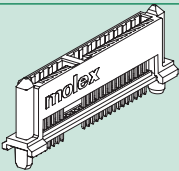
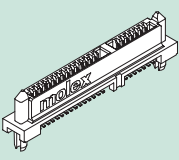
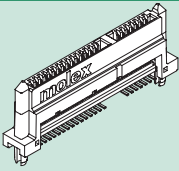
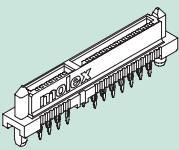
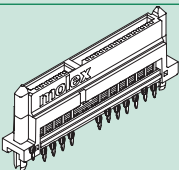
COMBO RECEPTACLES					
	Description	Lead-Free Order No.	Features		
			Plating	PCB Thickness	Mates With
	Vertical Backplane Receptacle, Through Hole, Standard Height	87779-1001	0.76µm/30µ" Gold	0.8mm (0.031") – 2.5mm (0.098")	87703 87679 87799
	Vertical Backplane Receptacle, Through Hole, Extended Height	87678-1001			
	Vertical Host SMT Receptacle, Standard Height	87713-1001			
	Vertical Host Receptacle, SMT, Extended Height	87781-1001		1.50mm (0.059") – 2.0mm (0.079")	
	Vertical Host Receptacle, Press-Fit, Standard Height	87701-1001			
	Vertical Host Receptacle, Press-Fit, Extended Height	87780-1001			

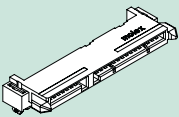
	Description	Lead-Free Order No.	Features		
			Plating	Unmated Height	Mates With
	Host Receptacle, SMT, Right Angle, Top Mount	47018-2000	Gold Flash	4.30mm (.169")	87679 87703 87799
		47018-2001	0.76µm/30µ" Gold		
		47018-2002	0.38µm/15µ" Gold		
		47018-3000	Gold Flash	4.70mm (.185")	
		47018-3001	0.76µm/30µ" Gold		
		47018-3002	0.38µm/15µ" Gold		
		47018-4000	Gold Flash	5.15mm (.203")	
		47018-4001	0.76µm/30µ" Gold		
47018-4002	0.38µm/15µ" Gold				

**CABLE ASSEMBLIES**

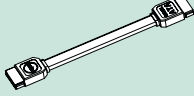
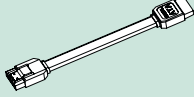
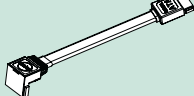
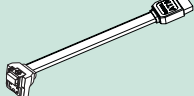
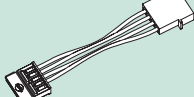
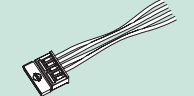
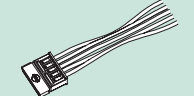
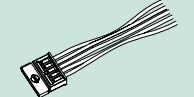
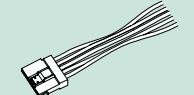
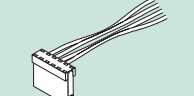
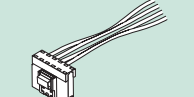
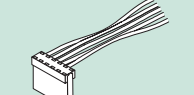
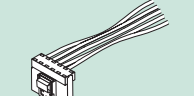
	Description	Lead-Free Order No.	Features		Mates With	
					Signal Plugs	Combo Plugs
	Signal Cable Assembly, Straight-To-Straight	88750-5310	0.5m, Grey	Contact Plating: 0.76µm/30µ" Gold	67490 67491	87679 87703 87799
		88750-5318	0.5m, Red			
		88750-5418	1.0m, Red			
	Signal Cable Assembly, Straight Latching-To-Straight Latching	68561-0014	0.5m, Red		67800 47080	87679
		68561-0015	1.0m, Red			
	Signal Cable Assembly, Straight-To-Right Angle	88762-5400	0.5m, Red		67490 67491	87679 87703 87799
		88762-5410	1.0m, Red			
	Signal Cable Assembly, Straight Latching-To-Right Angle Latching	68561-0016	0.5m, Red		67800 47080	87679
		68561-0017	1.0m, Red			
	Power Adapter, Crimping Type	88751-1310	6", Gold flash, (5V+12V)		87679 87703 87799	
		88751-1311	6", 0.76µm/30µ" Gold, (5V+12V)			
	4-pin Power Harness To Pigtail, Crimping Type	88751-1410	1.5m, Gold Flash, (5V+12V)			
		88751-1411	1.5m, 0.76µm/30µ" Gold, (5V+12V)			
	5-pin Power Harness To Pigtail, Crimping Type	88757-7810	1.5m, Gold Flash, (3.3V+5V+12V)			
		88757-7811	1.5m, 0.76µm/30µ" Gold, (3.3V+5V+12V)			
	Power Adapter, IDT Type	88761-4500	6", Gold Flash, (5V+12V) Feed-To Version			
		88761-4510	6", 0.76µm/30µ" Gold, (5V+12V) Feed-To-Version			
	Power Adapter, IDT With Latch Type	68561-0018	6", Gold Flash, (5V+12V) Feed-To Version	NA		87679
		68561-0019	6", 0.76µm/30µ" Gold, (5V+12V) Feed-To-Version			
	4-pin Power Harness To Pigtail, IDT Type	88761-4600	1.5m, Gold Flash, (5V+12V) Feed-To Version	87679 87703 87799		
		88761-4610	1.5m, 0.76µm/30µ" Gold, (5V+12V) Feed-To-Version			
	4-pin Power Harness To Pigtail, IDT With Latch Type	68561-0020	1.5m, Gold Flash, (5V+12V) Feed-To Version	87679		
		68561-0021	1.5m, 0.76µm/30µ" Gold, (5V+12V) Feed-To-Version			
	5-pin Power Harness To Pigtail, IDT Type	88761-4700	1.5m, Gold Flash, (3.3V+5V+12V) Feed-To Version	87679 87703 87799		
		88761-4710	1.5m, 0.76µm/30µ" Gold, (3.3V+5V+12V) Feed-To-Version			
	5-pin Power Harness To Pigtail, IDT With Latch Type	68561-0022	1.5m, Gold Flash, (3.3V+5V+12V) Feed-To Version	87679		
		68561-0023	1.5m, 0.76µm/30µ" Gold, (3.3V+5V+12V) Feed-To-Version			



*Bringing People & Technology Together, Worldwide<sup>SM</sup>*

**Far East South Headquarters**

Jurong, Singapore  
Tel: 65-6-268-6868  
fesinfo@molex.com

**Far East North Headquarters**

Yamato, Kanagawa, Japan  
Tel: 81-462-65-2324  
feninfo@molex.com

**Americas Headquarters**

2222, Wellington Court  
Lisle, Illinois 60532 U.S.A.  
Tel: 1-800-78MOLEX  
amerinfo@molex.com

**European Headquarters**

Munich, Germany  
Tel: 49-89-413092-0  
eurinfo@molex.com

**Corporate Headquarters**

2222 Wellington Court  
Lisle, Illinois 60532 U.S.A.  
Tel: 630-969-4550  
Fax: 630-969-1352

Visit our website at [www.molex.com](http://www.molex.com)