

BOTTOM VIEW OF CONNECTOR

3	B
2	B
1	B

NOTES PLEASE SEE PAGE 3 OF 3

REVISE AS PER EC NO. S2000-0130 DRAWN: REGINA SHAN 010313 CHK: APPR:	DESCRIPTION	QUALITY SYMBOLS	GENERAL TOLERANCES: (UNLESS SPECIFIED)		SCALE	DESIGN UNITS	THIRD ANGLE PROJECTION	DIMENSIONS:		SHT	REV
		MAJOR ▼ = 0	mm	INCH	NTS	<input checked="" type="checkbox"/> mm <input type="checkbox"/> INCH	<input checked="" type="checkbox"/> mm <input type="checkbox"/> INCH	<input type="checkbox"/> mm ONLY	3	B	
		CRITICAL ▽ = 0	4 PLACES ±0. ___ ±. ___		DRAWN BY & DATE REGINA SHAN 000512	TITLE: 1mm BOARD-TO-BOARD SMT RECEPTACLE CONNECTOR ASSEMBLY					
			3 PLACES ±0. ___ ±. 008		CHECKED BY & DATE LILY CHANG 000608	APPROVED BY & DATE S. K. TOH 000608					
		2 PLACES ±0. 20 ±. ___		APPROVED BY & DATE S. K. TOH 000608	MATERIAL NO. SEE TALBE						
		1 PLACE ±0. ___ ±. ___		CAD FILENAME	DRAWING NO. SD-87433-001		SHEET NO. 1 OF 3		SIZE A3		
		ANGULAR: ± °		THIS DRAWING CONTAINS INFORMATION THAT IS PROPRIETARY TO MOLEX INCORPORATED AND SHOULD NOT BE USED WITHOUT WRITTEN PERMISSION.							

TAPE AND REEL WIDTHS AND HOLE DIMENSIONS CONFORM TO EIA-481 STANDARDS.

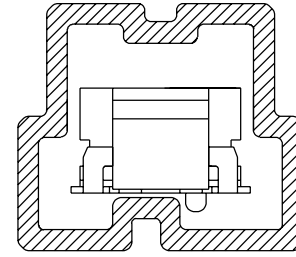
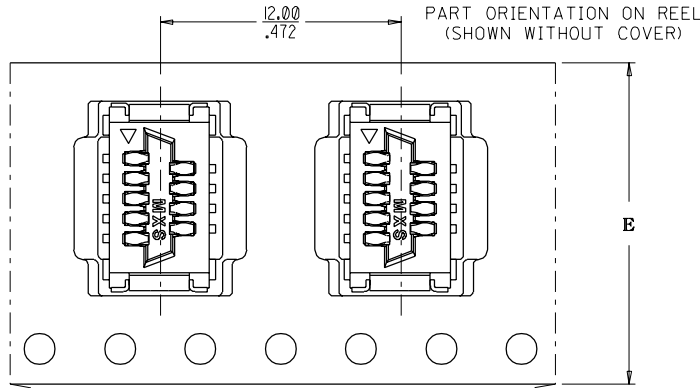

PART ORIENTATION IN TUBE

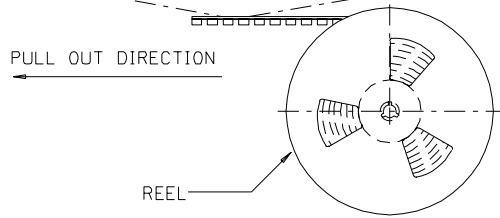

TOP TAPE LEADER

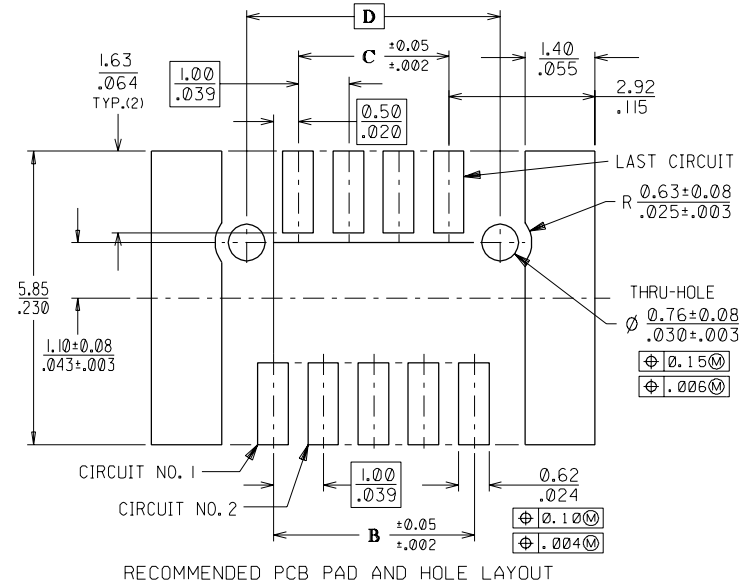
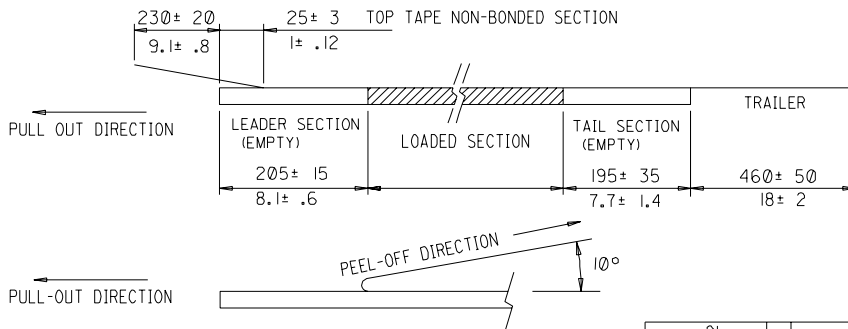

RECOMMENDED PCB PAD AND HOLE LAYOUT

REVISE AS PER EC NO. S2000-0130 CHK: REGINA SHAN 010312 APPR:	DESCRIPTION	QUALITY SYMBOLS	GENERAL TOLERANCES: (UNLESS SPECIFIED)		SCALE NTS	DESIGN UNITS	THIRD ANGLE PROJECTION	DIMENSIONS:	SHT	REV
		MAJOR ▼ = 0 CRITICAL ▽ = 0	mm	INCH	mm	INCH	mm	INCH	mm	mm ONLY
B	REV	4 PLACES	±0. —	±. —	DRAWN BY & DATE REGINA SHAN 000512	TITLE: 1mm BOARD-TO-BOARD SMT RECEPTACLE CONNECTOR ASSEMBLY	MATERIAL NO. SEE TABLE	DRAWING NO. SD-87433-001	SHEET NO. 2 OF 3	SIZE A3
		3 PLACES	±0. —	±. 008						
		2 PLACES	±0. 20	±. —	CAD FILENAME NA					
		1 PLACE	±0. —	±. —	ANGULAR: ± °					

CAD FILE S87433AB.DGN

DWG. NO. SD-87433-56*0

DO NOT SCALE DRAWING

TAPE AND REEL WIDTHS AND HOLE DIMENSIONS CONFORM TO EIA-481 STANDARDS.

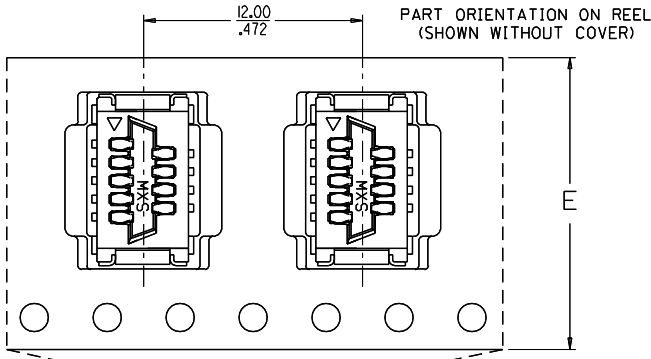

PART NO.	CKT. SIZE	PART QTY. PER REEL	DIMENSIONS				
			A	B	C	D	E
87433-56*0	11	1000	$\frac{10.30}{.406}$	$\frac{5.00}{.197}$	$\frac{4.00}{.157}$	$\frac{6.05}{.238}$	$\frac{24.00}{.945}$
87433-58*0	15	1000	$\frac{12.30}{.484}$	$\frac{7.00}{.276}$	$\frac{6.00}{.236}$	$\frac{8.05}{.317}$	$\frac{24.00}{.945}$

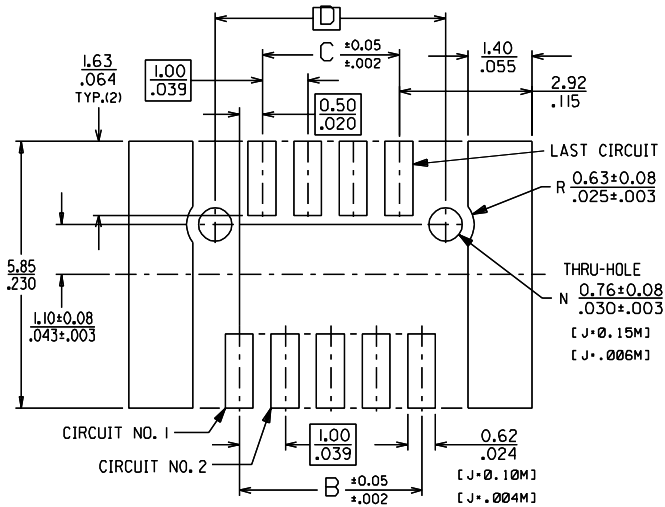
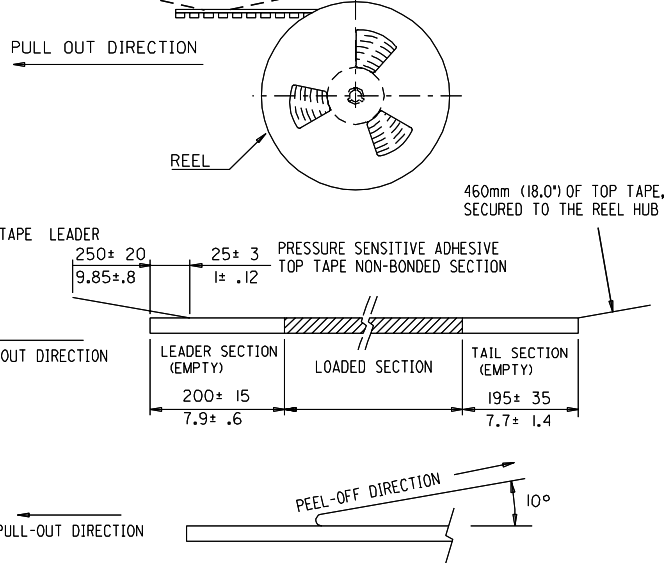

MM
INCH

				MATERIAL : SEE SHEET 1		MOLEX SINGAPORE PTE LTD SHEET 2 OF 2	
				FINISH :		GENERAL TOLERANCES ± 0.20/.008 REV B	
SEE SHEET 1				DRAWN BY		DWG. NO. SD-87433-56*0	
REVISION RECORD				APPR'D BY		TITLE : Imm BOARD-TO-BOARD SMT RECEPTACLE CONNECTOR ASSEMBLY	