

**PLEASE CHECK WWW.MOLEX.COM FOR LATEST PART INFORMATION**

**Part Number:** [0901301226](#)  
**Status:** **Active**  
**Overview:** C-Grid III™  
**Description:** C-Grid III™ Header, Dual Row, Vertical, Shrouded, Fully Loaded, 26 Circuits, Black, 0.38µm Gold (Au) Selective Plating

**Documents:**

[3D Model](#) [Packaging Specification PK-91814-005 \(PDF\)](#)  
[Drawing \(PDF\)](#) [RoHS Certificate of Compliance \(PDF\)](#)  
[Product Specification PS-99020-0001-001 \(PDF\)](#)

**Agency Certification**

CSA LR19980  
 UL E29179

**General**

Product Family PCB Headers  
 Series [90130](#)  
 Application Signal, Wire-to-Board  
 Overview [C-Grid III™](#)  
 Product Name C-Grid III™  
 UPC 800753698307

**Physical**

Breakaway No  
 Circuits (Loaded) 26  
 Circuits (maximum) 26  
 Color - Resin Black  
 Durability (mating cycles max) 100  
 First Mate / Last Break No  
 Flammability 94V-0  
 Glow-Wire Compliant No  
 Guide to Mating Part No  
 Keying to Mating Part None  
 Lock to Mating Part Yes  
 Material - Metal Brass  
 Material - Plating Mating Gold  
 Material - Plating Termination Tin  
 Material - Resin Polyester  
 Net Weight 2.869/g  
 Number of Rows 2  
 Orientation Vertical  
 PC Tail Length 2.90mm  
 PCB Locator No  
 PCB Retention None  
 PCB Thickness - Recommended 1.60mm  
 Packaging Type Tray  
 Pitch - Mating Interface 2.54mm  
 Pitch - Termination Interface 2.54mm  
 Plating min - Mating 0.381µm  
 Plating min - Termination 3.048µm  
 Polarized to Mating Part Yes  
 Polarized to PCB No  
 Shrouded Closed Ends  
 Stackable No  
 Surface Mount Compatible (SMC) No  
 Temperature Range - Operating -55°C to +125°C

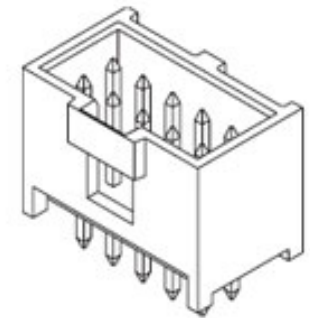

Series image - Reference only

**EU ELV**

**Not Relevant**

**EU RoHS**

**Compliant**

**REACH SVHC**

Not Contained Per  
 -ED/01/2017 (12  
 January 2017)

**Halogen-Free**

**Status**

**Not Low-Halogen**

**Need more information on product environmental compliance?**

Email [productcompliance@molex.com](mailto:productcompliance@molex.com)  
 Please visit the [Contact Us](#) section for any non-product compliance questions.

China ROHS

ELV

RoHS Phthalates

Green Image

Not Relevant

Not Contained

**Search Parts in this Series**

[90130](#) Series

**Mates With**

[90142](#) C-Grid III™ Crimp Housing

Termination Interface: Style Through Hole

**Electrical**

Current - Maximum per Contact 3.0A  
Voltage - Maximum 350V AC/DC

**Solder Process Data**

Duration at Max. Process Temperature (seconds) 003  
Lead-free Process Capability WAVE  
Max. Cycles at Max. Process Temperature 001  
Process Temperature max. C 235

**Material Info**

**Reference - Drawing Numbers**

Packaging Specification PK-91814-005  
Product Specification PS-99020-0001-001  
Sales Drawing SDA-90130

This document was generated on 03/03/2017

**PLEASE CHECK [WWW.MOLEX.COM](http://WWW.MOLEX.COM) FOR LATEST PART INFORMATION**