

PLEASE CHECK WWW.MOLEX.COM FOR LATEST PART INFORMATION

Part Number: [90814-3804](#)
Status: **Active**
Overview: [Picoflex®](#)
Description: 1.27mm Pitch Picoflex® PF-50 SMT Header with PCB Pegs, Vertical, Low Profile, Surface Mount, Gold (Au) Plated, 4 Circuits, Natural

Documents:

[3D Model](#) [Packaging Specification PK-90814-001 \(PDF\)](#)
[Drawing \(PDF\)](#) [RoHS Certificate of Compliance \(PDF\)](#)
[Product Specification PS-99020-0011 \(PDF\)](#)

Agency Certification

UL E29179

General

Product Family PCB Headers
 Series [90814](#)
 Application Signal, Wire-to-Board
 Application Tooling Part Link 690081070
 Comments Low Profile
 Overview [Picoflex®](#)
 Product Name Picoflex®
 UPC 800756883847

Physical

Breakaway No
 Circuits (Loaded) 4
 Circuits (maximum) 4
 Color - Resin Natural
 Durability (mating cycles max) 100
 First Mate / Last Break No
 Flammability 94V-0
 Glow-Wire Compliant No
 Guide to Mating Part No
 Keying to Mating Part None
 Lock to Mating Part Yes
 Material - Metal Brass
 Material - Plating Mating Gold
 Material - Resin High Temperature Thermoplastic
 Net Weight 0.262/g
 Number of Rows 1
 Orientation Vertical
 PCB Locator Yes
 PCB Retention Yes
 PCB Thickness - Recommended 1.60mm
 Packaging Type Tube
 Pitch - Mating Interface 1.27mm
 Pitch - Termination Interface 1.27mm
 Plating min - Mating 0.762µm
 Plating min - Termination 0.102µm
 Polarized to Mating Part Yes
 Polarized to PCB Yes
 Shrouded No
 Stackable No
 Surface Mount Compatible (SMC) Yes
 Temperature Range - Operating -40°C to +105°C

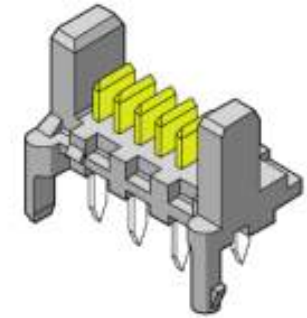

image - Reference only

Series

EU RoHS

ELV and RoHS Compliant

REACH SVHC

Not Reviewed

Low-Halogen Status

Not Low-Halogen

China RoHS



Need more information on product environmental compliance?

Email productcompliance@molex.com
 For a multiple part number RoHS Certificate of Compliance, [click here](#)

Please visit the [Contact Us](#) section for any non-product compliance questions.

Search Parts in this Series

[90814Series](#)

Mates With

[90327 IDT Connector](#)

Application Tooling | FAQ

Tooling specifications and manuals are found by selecting the products below. Crimp Height Specifications are then contained in the Application Tooling Specification document.

Global

Description

Product #

Extraction Tool (Plastic) for 4-26 Circuit

[0690081070](#)

Termination Interface: Style Surface Mount

Electrical

Current - Maximum per Contact 2.4A
Voltage - Maximum 250V AC/DC

Material Info

Reference - Drawing Numbers

Packaging Specification PK-90814-001
Product Specification PS-99020-0011
Sales Drawing SDA-90814

This document was generated on 01/15/2013

PLEASE CHECK WWW.MOLEX.COM FOR LATEST PART INFORMATION