

## Data Sheet

# Safety Standard Certified Type KX (Reinforced Insulation) (UL, CSA, IEC60384-14 ClassX1/Y1)

## DE1E3KX102MA5BA01 (E, 1000pF, AC250V)

RoHS regulation conformity parts

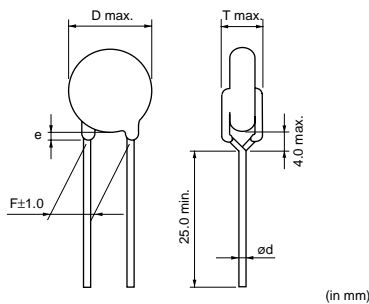

Lead Code	Coating Extension e	ød
A5	Up to the end of crimp	0.6 <sup>0.1</sup> ±0.05

### ■ Dimensions

Body Diameter D	8mm max.
Body Thickness T	8.0mm max.
Lead Spacing F	10.0mm ±1.0mm
Lead Diameter ød	0.6mm +0.1/-0.05mm
Coating Extension e	Up to the end of crimp

### ■ Rated Value

	Murata PN Code	Spec
Temperature Char.	<b>E3</b>	E, +20/-55%
Capacitance	<b>102</b>	1000pF
Capacitance Tol.	<b>M</b>	±20%
Safety Standard Certified Type	<b>KX</b>	X1,Y1: AC250V(r.m.s.)

### ■ Lead Style

Code	Lead Style
<b>A5</b>	Vertical crimp long

### ■ Packaging

Code	Packaging	Minimum Quantity
<b>B</b>	Bulk	250

Please refer to 'Packaging' for the details.

### ■ Specifications

Please refer to  
'Safety standard certified Type KY/KH/KX  
Specifications and Test Methods'  
PDF file.

### ■ Standard Certification

	Standard No.	Certified No.	Rated Voltage
UL	UL1414	E37921	AC250V(r.m.s.)
CSA	CSA E60384-14	1343810	
VDE	IEC 60384-14 EN 60384-14	40002831	
BSI	EN 60065 (8.8, 14.2) IEC 60384-14 EN 60384-14	KM 37901	
SEMKO	IEC 60384-14 EN 60384-14	812158	
DEMKO		314577	
FIMKO		24191	
NEMKO		P08209173	
ESTI		08.0707	
IMQ	EN 60384-14	V4069	

- The certification number might change due to revision of the application standard and changes in the range of acquisition.
- Please contact us when the certification of Chinese Safety Standard or South Korean Safety Standard is necessary.

- This data sheet is applied for SAFETY STANDARD CERTIFIED CERAMIC CAPACITOR Type KX used for General Electronics equipment for your design.

#### <Notice>

- Bonding, resin molding and coating  
In case of bonding, molding or coating this product, verify that these processes do not affect the quality of capacitor by testing the performance of the bonded, molded or coated product in the intended equipment. The variation in thickness of adhesive or molding resin or coating may cause an outer coating resin cracking and/or ceramic element cracking of a capacitor in a temperature cycling.
- Please refer to 'Caution' and 'Notice' for the other details.

- The RoHS compliance means that we judge from EU Directive 2002/95/EC the products do not contain lead, cadmium, mercury, hexavalent chromium, PBB and PBDE, except exemptions stated in EU Directive 2002/95/EC annex and impurities existing in natural world.
- This statement does not insure the compliance of any of the listed parts with any laws or legal imperatives developed by any EU members individually with regards to the RoHS Directive.

#### ⚠ Note:

1. This datasheet is downloaded from the website of Murata Manufacturing co., Ltd. Therefore, it's specifications are subject to change or our products in it may be discontinued without advance notice. Please check with our sales representatives or product engineers before ordering.
2. This datasheet has only typical specifications because there is no space for detailed specifications. Therefore, please approve our product specifications or transact the approval sheet for product specifications before ordering.