



GRM2162C1H121JA01#

"#" indicates a package specification code.

Available   Complies with RoHS

< List of part numbers with package codes >
 GRM2162C1H121JA01D , GRM2162C1H121JA01J , GRM2162C1H121JA01C , GRM2162C1H121JA01B

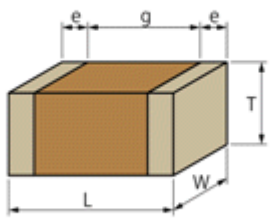
Shape

 	
L size	2.0 ± 0.1mm
W size	1.25 ± 0.1mm
T size	0.6 ± 0.1mm
External terminal width e	0.2 to 0.7mm
Distance between external terminals g (Min.)	0.7mm
Size code in mm(inch)	2012 (0805)

References

Packaging	Specifications	Minimum quantity
D	Paper tape (180mm)	4000
J	Paper tape (330mm)	10000
C	Bulk case	10000
B	Packing in bulk	1000

Mass (typ.)	
1 piece	6.4mg
Reel (180mm)	126g

Specifications

Capacitance	120pF ± 5%
Rated voltage	50Vdc
Temperature characteristics (complied standard)	CH(JIS)
Temperature coefficient	0 ± 60ppm/
Temperature range of temperature characteristics	20 to 125
Operating temperature range	-55 to 125

Attention

- 1.This datasheet is downloaded from the website of Murata Manufacturing Co., Ltd. Therefore, it ' s specifications are subject to change or our products in it may be discontinued without advance notice. Please check with our sales representatives or product engineers before ordering.
- 2.This datasheet has only typical specifications because there is no space for detailed specifications. Therefore, please review our product specifications or consult the approval sheet for product specifications before ordering.