

FEATURES

- STANDARD EIA 1206 & 0805 PACKAGING
- EACH COMPONENT CONTAINS 4 ISOLATED CERAMIC CAPACITORS
- AVAILABLE IN A WIDE RANGE OF VALUES AND TEMPERATURE COEFFICIENTS

RoHS Compliant

Includes all homogeneous materials

*See Part Number System for Details

SPECIFICATIONS	NPO	X7R	X5R	Y5V
OPERATING TEMPERATURE	-55°C~ +125°C	-55°C~ +125°C	-55°C~ +85°C	-30°C~ +85°C
CAPACITANCE RANGE	10pF ~ 1000pF	100pF ~ 0.1μF	0.1μF	0.01μF ~ 0.33μF
VOLTAGE RANGE	SEE VALUES TABLES			
CAPACITANCE TOLERANCE	±5% (J), ±10%(K)	±10%(K), ±20%(M)	±10%(K), ±20%(M)	+80%/-20% (Z)
TEMPERATURE CHARACTERISTICS	0±30ppm	±15%	±15%	+30% ~ -80%
DIELECTRIC WITHSTANDING VOLTAGE	2.5 x Rated Voltage for 1 minute			
INSULATION RESISTANCE (after 1 minute)	>10GΩ	>10GΩ	>10GΩ	>10GΩ
DISSIPATION FACTOR	≤ 0.1%	≤ 5%	≤ 5%	≤ 7%

STANDARD VALUES AND VOLTAGES

Cap.	NPO				X7R					Y5V		
	Working Voltage (Vdc)											
	16	25	50	100	10	16	25	50	100	16	25	50
10pF	‡	‡	‡	‡								
22pF	‡	‡	‡	‡								
33pF	‡	‡	‡	‡								
47pF	‡	‡	‡	‡								
68pF	‡	‡	‡	‡								
82pF	‡	‡	‡	‡								
100pF	‡	‡	‡	‡		□	□					
220pF	‡	‡	‡	‡		□	□					
330pF	‡	‡	‡	‡		□	□	‡				
470pF	‡	‡	‡			‡	‡	‡	‡			
680pF	‡	‡				‡	‡	‡	‡			
820pF	‡	‡				‡	‡	‡	‡			
.001μF	‡	‡				‡	‡	‡	‡			
.0022μF						‡	‡	‡	‡			
.0033μF						‡	□	‡	‡			
.0047μF						‡	□	‡	‡			
.0068μF						‡	□	‡	‡			
.0082μF						‡	‡	‡	‡			
.01μF						□	‡	‡	‡	‡	‡	‡
.022μF						□	‡	‡	‡		‡	‡
.033μF						□	‡	‡	‡		‡	‡
.047μF						□	‡	‡			‡	‡
.068μF						□	‡	‡			‡	‡
.082μF						□	‡				‡	‡
0.1μF						□*	‡				‡	‡

0805 Values □ 1206 Values ‡

* X5R TC -55°C ~ +85°C

PART DIMENSIONS (mm)

Series	NCA0805	NCA1206
L	2.00 ± 0.20	3.20 ± 0.20
W	1.25 ± 0.20	1.60 ± 0.20
H	1.00 max.	1.30 max.
S	0.50 ± 0.10	0.80 ± 0.20
T	0.28 ± 0.10	0.40 ± 0.10
B	0.25 ± 0.15	0.30 ± 0.20

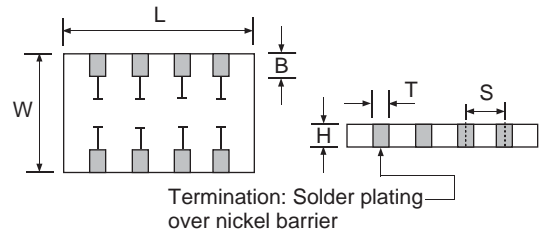

RECOMMENDED LAND PATTERN (mm)

Series	A	B	C	D
NCA0805	1.65 ± 0.10	0.55 ± 0.05	0.5 ± 0.05	0.25 ± 0.05
NCA1206	2.60 ± 0.10	0.80 ± 0.05	0.8 ± 0.10	0.45 ± 0.1

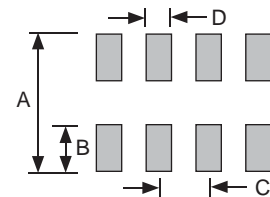

PART NUMBER SYSTEM

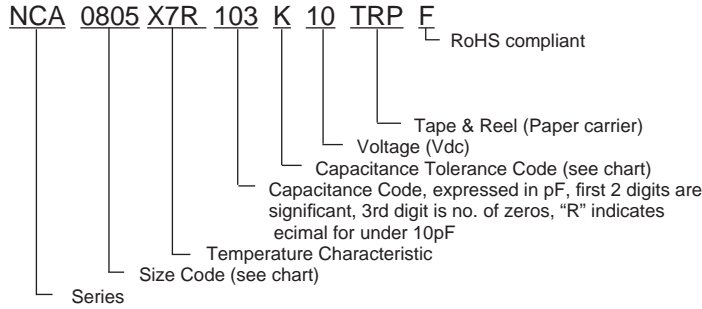

TAPE DIMENSIONS (mm)

A ₀	B ₀	F	G	K	P ₀	P ₁	P ₂	T	W
See note 1		3.50 ±0.05	1.75 ±0.1	2.50 max.	4.0 ±0.1	4.0 ±0.1	2.0 ±0.05	0.6 max.	8.0 ±0.3

Note 1 - These dimensions are determined by the maximum dimensions of the part. Clearance between the sides of the components shall be 0.05mm (min.) and 0.50mm (max). The clearance shall not allow the component to rotate more than 20° within the carrier cavity.

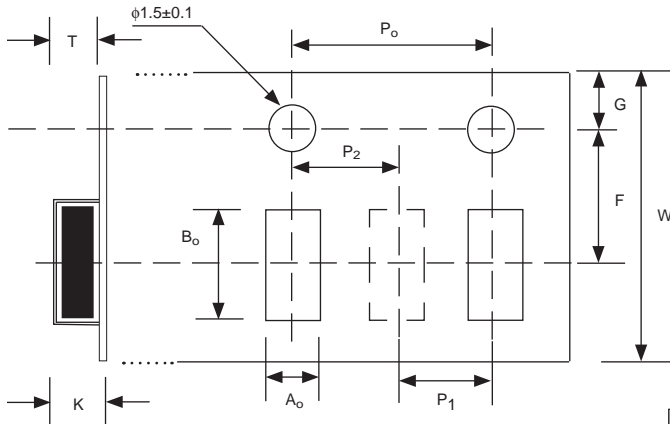

REEL DIMENSIONS (mm)

A	B	C	D	E	W
178 ± 2.0	50 min.	13.0 ± 0.2	20.2 min.	1.5 min.	8.4 ± 1.0

