

HIGH TEMPERATURE, EXTENDED LOAD LIFE, RADIAL LEADS, POLARIZED  
**FEATURES**

- IMPROVED ENDURANCE AT HIGH TEMPERATURE  
 (up to 10,000HRS @ 105°C)
- IDEAL FOR LOW VOLTAGE LIGHTING BALLAST

**RoHS  
 Compliant**  
 includes all homogeneous materials

\*See Part Number System for Details



### CHARACTERISTICS

Rated Voltage Range		10 ~ 100VDC						
Capacitance Range		0.47 ~ 330μF						
Operating Temperature Range		-25°C ~ +105°C						
Capacitance Tolerance		±20% (M)						
Maximum Leakage Current @ 20°C	After 2 min.	0.01CV or 3μA whichever is greater						
Max. Tan δ	W.V. (Vdc)	10	16	25	35	50	63	100
	S.V. (Vdc)	13	20	32	44	63	79	125
	@ 120Hz/20°C	0.45	0.35	0.30	0.22	0.19	0.17	0.15
Low Temperature Stability Impedance Ratio @ 120Hz		Z-25°C/Z+20°C	8	6	4	4	3	3
Load Life Test at Rated Volt- age @ 105°C	Duration	10,000 hours						
	Δ Capacitance	Within ±25% of initial measured value						
	Δ Tan δ	Less than 300% of specified value						
	Δ LC	Less than specified value						

### STANDARD PRODUCT AND CASE SIZE TABLE Dφ x L (mm)

Cap. (μF)	Code	Working Voltage (Vdc)						
		10	16	25	35	50	63	100
0.47	R47	-	-	-	-	5x11	-	5x11
1.0	1R0	-	-	-	-	5x11	-	5x11
2.2	2R2	-	-	-	-	5x11	-	5x11
3.3	3R3	-	-	-	-	5x11	-	5x11
4.7	4R7	-	-	-	-	5x11	-	5x11
10	100	-	-	-	-	5x11	5x11	6.3x11
22	220	-	-	-	-	5x11	6.3x11	8x11.5
33	330	-	-	5x11	5x11	6.3x11	6.3x11	-
47	470	-	5x11	5x11	6.3x11	6.3x11	8x11.5	-
100	101	5x11	6.3x11	6.3x11	8x11.5	8x11.5	-	-
220	221	6.3x11	8x11.5	-	-	-	-	-
330	331	8x11.5	-	-	-	-	-	-

### PART NUMBER SYSTEM

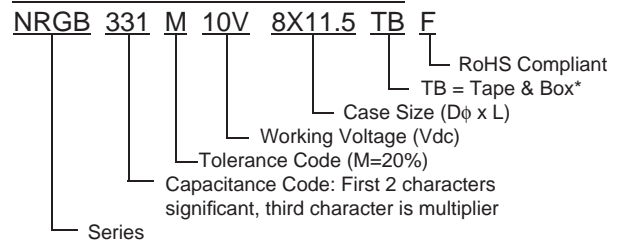

\*see taping specifications for details

Drawing is representative of parts as supplied in bulk or straight lead format, please see taping specifications for details on taped format packaging.

### LEAD SPACING AND DIAMETER (mm)

Case Dia. (Dφ)	5	6.3	8
Lead Dia. (dφ)	0.5	0.5	0.6
Lead Spacing (F)	2.0	2.5	3.5
Dim. α	0.5		
Dim. β	1.5		

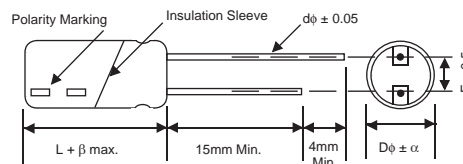

### PRECAUTIONS

Please review the notes on correct use, safety and precautions found on pages T10 & T11 of NIC's Electrolytic Capacitor catalog.  
 Also found at [www.niccomp.com/precautions](http://www.niccomp.com/precautions)  
 If in doubt or uncertainty, please review your specific application - process details with NIC's technical support personnel: [tpmg@niccomp.com](mailto:tpmg@niccomp.com)



### STANDARD VALUES, SPECIFICATIONS AND CASE SIZES (mm)

Part Number	Cap. (μF)	W.V. (Vdc)	Dissipation Factor +20°C/120Hz	Ripple Current Rating (mA) +105°C/100KHz	Max. ESR (Ω) +20°C/100KHz	Load Life Hours @+105°C	
NRGB101M10V5x11F	100	10	0.45	130	7.46	10,000	
NRGB221M10V6.3x11F	220		0.45	210	3.39	10,000	
NRGB331M10V8x11.5F	330		0.45	330	2.26	10,000	
NRGB470M16V5x11F	47	16	0.35	130	12.4	10,000	
NRGB101M16V6.3x11F	100		0.35	210	5.81	10,000	
NRGB221M16V8x11.5F	220		0.35	330	2.64	10,000	
NRGB330M25V5x11F	33	25	0.30	130	15.1	10,000	
NRGB470M25V5x11F	47		0.30	130	10.6	10,000	
NRGB101M25V6.3x11F	100		0.30	210	4.98	10,000	
NRGB330M35V5x11F	33	35	0.22	130	11.1	10,000	
NRGB470M35V6.3x11F	47		0.22	210	7.76	10,000	
NRGB101M35V8x11.5F	100		0.22	330	3.65	10,000	
NRGBR47M50V5x11F	0.47	50	0.19	12	670.5	10,000	
NRGB1R0M50V5x11F	1.0		0.19	25	315.2	10,000	
NRGB2R2M50V5x11F	2.2		0.19	35	143.3	10,000	
NRGB3R3M50V5x11F	3.3		0.19	70	95.5	10,000	
NRGB4R7M50V5x11F	4.7		0.19	80	67.1	10,000	
NRGB100M50V5x11F	10		0.19	90	31.5	10,000	
NRGB220M50V5x11F	22		0.19	110	14.3	10,000	
NRGB330M50V6.3x11F	33		0.19	190	9.55	10,000	
NRGB470M50V6.3x11F	47		0.19	190	6.71	10,000	
NRGB101M50V8x11.5F	100		0.19	270	3.15	10,000	
NRGB100M63V5x11F	10		63	0.17	80	28.2	10,000
NRGB220M63V6.3x11F	22			0.17	170	12.8	10,000
NRGB330M63V6.3x11F	33			0.17	170	8.54	10,000
NRGB470M63V8x11.5F	47			0.17	240	6.00	10,000
NRGBR47M100V5x11F	0.47		100	0.15	20	529.4	10,000
NRGB1R0M100V5x11F	1.0	0.15		40	248.8	10,000	
NRGB2R2M100V5x11F	2.2	0.15		50	113.1	10,000	
NRGB3R3M100V5x11F	3.3	0.15		60	75.4	10,000	
NRGB4R7M100V5x11F	4.7	0.15		70	52.9	10,000	
NRGB100M100V6.3x11F	10	0.15		150	24.9	10,000	
NRGB220M100V8x11.5F	22	0.15		230	11.3	10,000	

### RIPPLE CURRENT FREQUENCY CORRECTION FACTOR

Frequency (Hz)	Cap. (μF)	120	1K	10K	100K
Multiplier	0.47 ~ 10	0.42	0.60	0.80	1.00
	22 ~ 33	0.55	0.75	0.90	1.00
	47 ~ 330	0.70	0.85	0.95	1.00

# Miniature Aluminum Electrolytic Capacitors Taping Specifications

## STANDARD RADIAL TAPING (5mm LEAD SPACING, FORMED LEADS) TR, TB

Taping Dimensions (mm)

Case Dia. (D $\phi$ )	4	5	6.3	8
Case Size	4x5	5x5	6.3x5	8x11.5
Dim.	4x7	5x7	6.3x7	6.3x11
d $\phi$ $\pm$ 0.05	0.45	0.45	0.5	0.5
H $\pm$ 0.75	17.5	17.5	18.5	18.5
F +0.8 ~ -0.2	5.0 -0.2 ~ +0.8			
P	12.7 $\pm$ 1.0			
P <sub>0</sub>	12.7 $\pm$ 0.2			
P <sub>1</sub>	3.85 $\pm$ 0.5 (at end of tape)			
P <sub>2</sub>	6.35 $\pm$ 1.0			
W	18.0 $\pm$ 0.5			
W <sub>0</sub>	11.5 min.			
W <sub>1</sub>	9.0 $\pm$ 0.5			
W <sub>2</sub>	0 ~ 2.5			
H <sub>0</sub>	16.0 $\pm$ 0.5			
l	1.0 max.			
D <sub>0</sub> $\phi$	4.0 $\pm$ 0.2			
$\Delta$ h	0 $\pm$ 1.0 (at top of can)			
t	0.7 $\pm$ 0.2 (not including lead)			

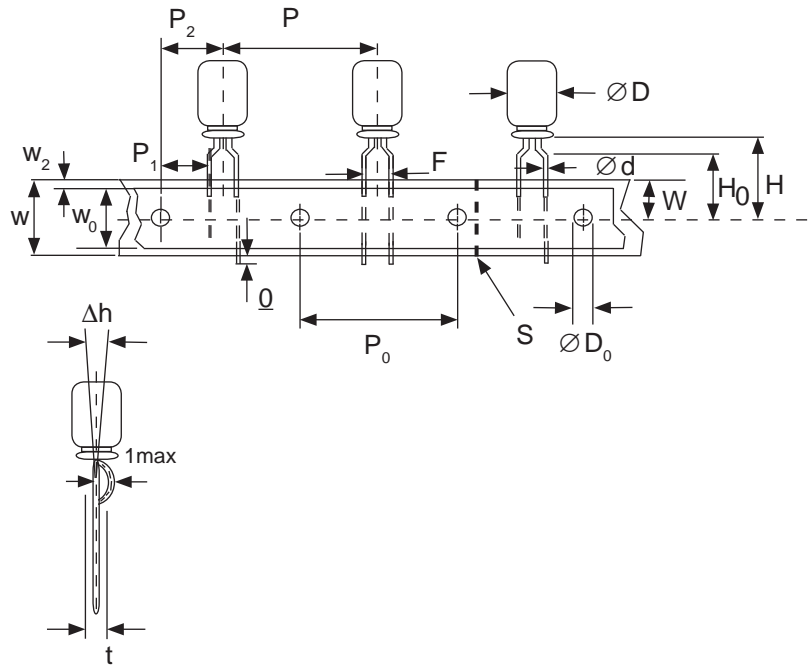

## STANDARD RADIAL TAPING (5mm LEAD SPACING, STRAIGHT LEADS) TR, TB

Taping Dimensions (mm)

Case Dia. (D $\phi$ )	10	12.5
Case Size	All	All
Dim.	All	All
d $\phi$ $\pm$ 0.05	0.6	0.6
H $\pm$ 0.75	19.0	19.0
F +0.8 ~ -0.2	5.0	5.0
P $\pm$ 1.0	25.4*	
P <sub>0</sub>	12.7 $\pm$ 0.2	
P <sub>1</sub>	3.85	
P <sub>2</sub>	6.35 $\pm$ 1.0	
W	18.0 $\pm$ 0.5	
W <sub>0</sub>	11.5 min	
W <sub>1</sub>	9.0 $\pm$ 0.5	
W <sub>2</sub>	0 ~ 2.5	
H <sub>0</sub>	16.0 $\pm$ 0.5	
l	1.0 max.	
D <sub>0</sub> $\phi$	4.0 $\pm$ 0.2	
$\Delta$ h	0 $\pm$ 1.0 (at top of can)	
t	0.7 $\pm$ 0.2 (not including lead)	

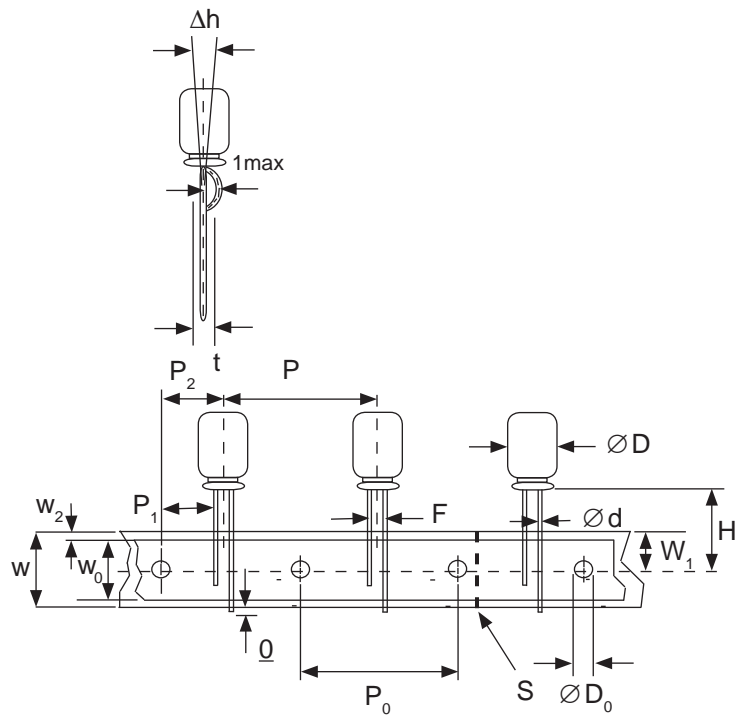

### \*Optional Taping Specifications

10mm diameter available with P dim. = 12.7mm  
(P/N Suffix: TB12.7MMP)

12.5mm diameter available with P dim. = 15mm, P<sub>1</sub> = 5.0mm,  
P<sub>0</sub> = 15.0mm & P<sub>2</sub> = 7.5mm (P/N Suffix: TB15MMP)

**NOTE:** ANODE (+) LEAD FEEDS OFF FIRST.  
FOR OPTION OF NEGATIVE (-) LEAD FIRST,  
SPECIFY "TRN" OR "TBN".



# Miniature Aluminum Electrolytic Capacitors Taping Specifications

## SPECIAL RADIAL TAPING (2.5mm LEAD SPACING, FORMED LEADS) TRF1, TBF1

Taping Dimensions (mm)

Case Dia. (D $\phi$ )	4		5	
Case Size Dim.	4x5 4x7	5x5 5x7	5x11	
d $\phi$ $\pm$ 0.05	0.45	0.45	0.5	
H $\pm$ 0.75	17.5	17.5	18.5	
H <sub>0</sub> $\pm$ 0.5	16.0	-	-	
F	2.5 -0.2 ~ +0.8			
P	12.7 $\pm$ 1.0			
P <sub>0</sub>	12.7 $\pm$ 0.2			
P <sub>1</sub>	5.1 $\pm$ 0.5			
P <sub>2</sub>	6.35 $\pm$ 1.0			
W	18.0 $\pm$ 0.5			
W <sub>0</sub>	11.5 min.			
W <sub>1</sub>	9.0 $\pm$ 0.5			
W <sub>2</sub>	0 ~ 1.5			
l	1.0 max.			
D <sub>0</sub> $\phi$	4.0 $\pm$ 0.2			
$\Delta$ h	0 $\pm$ 1.0			
t	0.7 $\pm$ 0.2			

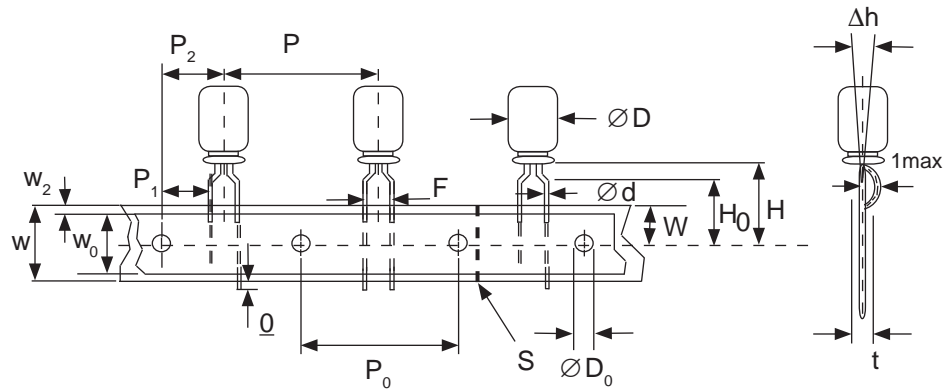

## SPECIAL STRAIGHT LEAD TAPING TRST, TBST

Taping Dimensions (mm)

Case Dia. (D $\phi$ )	4			5			6.3		8	
Case Size Dim.	4x5 4x7	5x5 5x7	5x11		6.3x5 6.3x7	6.3x11	8x11.5			
d $\phi$ $\pm$ 0.05	0.45	0.45	0.5	0.45	0.5	0.6				
H $\pm$ 0.75	17.5	17.5	18.5	17.5	18.5	20.0				
F +0.8 ~ -0.2	2.0*	2.0	2.0	2.5	2.5	3.5				
P $\pm$ 1.0	12.7 $\pm$ 0.2									
P <sub>0</sub>	12.7 $\pm$ 0.2									
P <sub>1</sub>	5.1	5.1	5.1	5.1	5.1	4.6				
P <sub>2</sub>	6.35 $\pm$ 1.0									
W	18.0 $\pm$ 0.5									
W <sub>0</sub>	11.5 min.									
W <sub>1</sub>	9.0 $\pm$ 0.5									
W <sub>2</sub>	0 ~ 2.5									
H <sub>0</sub>	16.0 $\pm$ 0.5									
l	1.0 max.									
D <sub>0</sub> $\phi$	4.0 $\pm$ 0.2									
$\Delta$ h	0 $\pm$ 1.0 (at top of can)									
t	0.7 $\pm$ 0.2 (not including lead)									

\* Parts with 4mm diameter are taped with a slight flare in the lead and a 2.0mm lead-space.

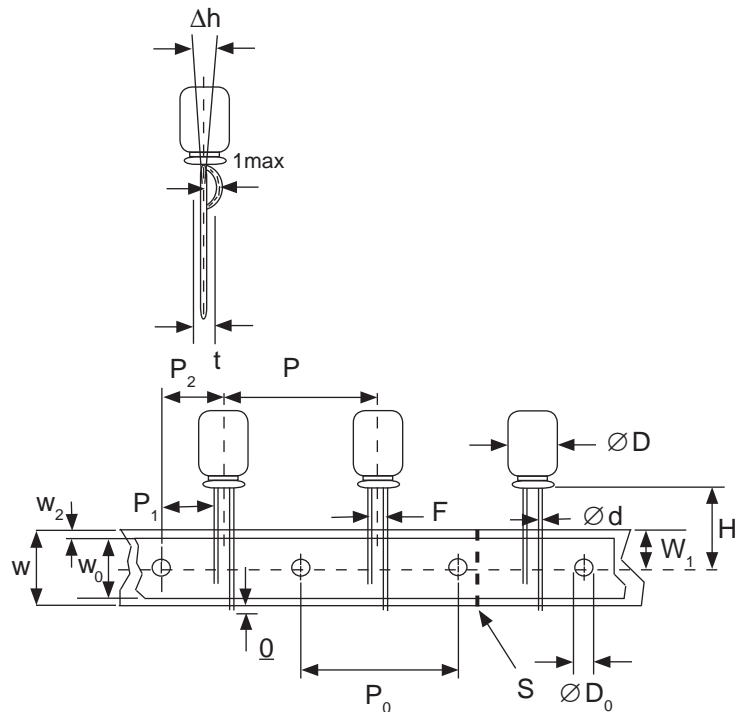

# Miniature Aluminum Electrolytic Capacitors Taping Specifications

## RADIAL TAPED PACKAGING

Ammo Box (Tape & Box) TB, TBF, TBST

Size of box and component quantity

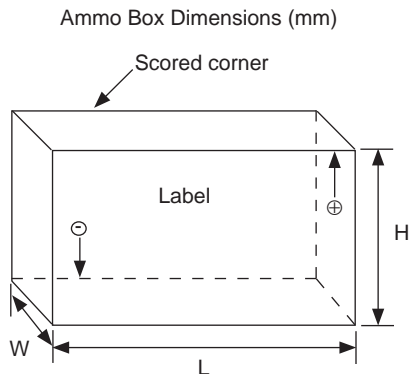

Case Dia (D $\phi$ ) or Case Size	Q'ty per Box (pcs)	Dim. L	Dim. H	Dim. W
4x5, 4x7	2,000	331	175	43
5x5, 5x7	2,000	331	220	43
5x11	2,000	340	255	55
6.3x5, 6.3x7	2,000	331	280	43
6.3x11	2,000	331	280	48
8x11.5, 8x12.5	1,000	335	235	53
10x12.5*	500	335	190	53
10x16*	500	335	300	53
10x20*	500	335	300	55
12.x20*	500	335	300	55
12.5x25*	500	335	300	61

\*Special Taping Consult Factory For Availability

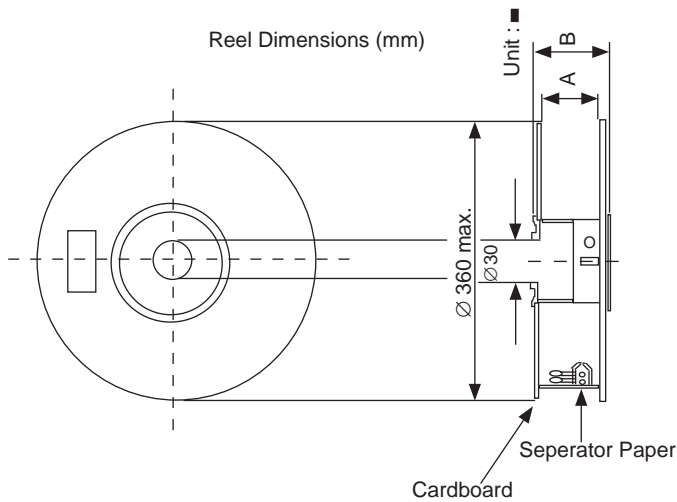

Reel Packages (Tape & Reel) TR, TRF1, TRST

Size of reel and component quantity

Case Dia (D $\phi$ ) or Case Size	Q'ty per Box (pcs)	Dim. A	Dim. B
4 $\phi$	1,800	42	52
5 $\phi$	1,500	42	52
6.3 $\phi$	1,000	42	52
8 $\phi$	800	42	52
10x12.5*	600	42	52
10x16*	600	48	56
10x20*	600	52	60
12.x20*	250	52	60
12.5x25*	250	56	64

\*Special Taping Consult Factory For Availability

