

LOW IMPEDANCE AT HIGH FREQUENCY RADIAL LEADS, POLARIZED ALUMINUM ELECTROLYTIC CAPACITORS

### FEATURES

- VERY LOW IMPEDANCE
- LONG LIFE AT 105°C (2000 ~ 5000 hrs.)
- HIGH STABILITY AT LOW TEMPERATURE
- IDEALLY FOR USE IN SWITCHING POWER SUPPLIES AND CONVERTORS

**RoHS Compliant**  
includes all homogeneous materials

\*See Part Number System for Details

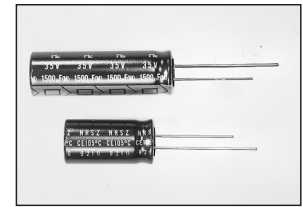

### CHARACTERISTICS

Rated Voltage Range	6.3 ~ 100VDC									
Capacitance Range	0.47 ~ 12,000μF									
Operating Temperature Range	-55 ~ +105°C									
Capacitance Tolerance	±20% (M)									
Max. Leakage Current @ 20°C	After 1 min.	0.03CV or 4μA, whichever is greater								
	After 2 min.	0.01CV or 3μA, whichever is greater								
Max. Tanδ ~ 120Hz/20°C	W.V. (VDC)	6.3	10	16	25	35	50	63	100	
	S.V. (VDC)	8	13	20	32	44	63	79	125	
	C < 1,200μF	0.22	0.19	0.16	0.14	0.12	0.10	0.08	0.07	
	C = 1,500μF	0.23	0.20	0.17	0.15	0.13	0.11	-	-	
	C = 1,800μF	0.23	0.20	0.17	0.15	0.13	0.11	-	-	
	C = 2,200μF	0.24	0.21	0.18	0.16	0.14	-	-	-	
	C = 2,700μF	0.25	0.22	0.19	0.17	0.15	-	-	-	
	C = 3,300μF	0.26	0.23	0.20	0.18	0.16	-	-	-	
	C = 3,900μF	0.28	0.25	0.22	0.20	-	-	-	-	
	C = 4,700μF	0.29	0.26	0.23	0.21	-	-	-	-	
	C = 5,600μF	0.31	0.28	0.25	-	-	-	-	-	
	C = 6,800μF	0.33	0.30	0.27	-	-	-	-	-	
	C = 8,200μF	0.36	0.33	-	-	-	-	-	-	
Low Temperature Stability Impedance Ratio @ 120Hz	Z-25°C/Z+20°C	3	2	2	2	2	2	2	2	
	Z-40°C/Z+20°C	4	3	3	3	3	3	3	3	
Load Life Test at Rated W.V. & 105°C 5,000 hours: 12.5 ~ 18φ 3,000 hours: 8 ~ 10φ 2,000 hours: 5 ~ 6.3φ	Capacitance Change	Within ±20% of initial measured value								
	Tanδ	Less than 200% of specified maximum value								
	Leakage Current	Less than specified maximum value								
Shelf Life Test 105°C for 1,000 hours No Load	Capacitance Change	Within ±20% of initial measured value								
	Tanδ	Less than 200% of specified maximum value								
	Leakage Current	Less than specified maximum value								

**LOW IMPEDANCE**  
**NRSZ** ➔ **NRSY**  
(today's standard) (reduced sizes)

\*NRSZ102M6.3V8X20 is 4,500 Hours @ 105°C

Unless otherwise specified here, capacitor shall meet JIS C-5141 Characteristics W.

### RIPPLE CURRENT CORRECTION FACTORS

Frequency (Hz)	Cap. (μF)	120	1K	10K	100K
Multiplier	0.47 ~ 4.7	0.40	0.68	0.78	1.00
	5.6 ~ 47	0.50	0.76	0.87	1.00
	56 ~ 270	0.70	0.85	0.90	1.00
	330 ~ 1000	0.80	0.93	0.98	1.00
	1200 ~ 12000	0.90	0.95	1.0	1.0

### PRECAUTIONS

Please review the notes on correct use, safety and precautions found on pages T10 & T11 of NIC's Electrolytic Capacitor catalog.  
Also found at [www.niccomp.com/precautions](http://www.niccomp.com/precautions)  
If in doubt or uncertainty, please review your specific application - process details with NIC's technical support personnel: [tpmg@niccomp.com](mailto:tpmg@niccomp.com)



### LEAD SPACING AND DIAMETER (mm)

Case Dia. (D $\phi$ )	5	6.3	8	10	12.5	16	18
Lead Dia. (d $\phi$ )	0.5	0.5	0.6	0.6	0.6	0.8	0.8
Lead Spacing (F)	2.0	2.5	3.5	5.0	5.0	7.5	7.5
Dim. $\alpha$	0.5						
Dim. $\beta$	1.0			2.0			

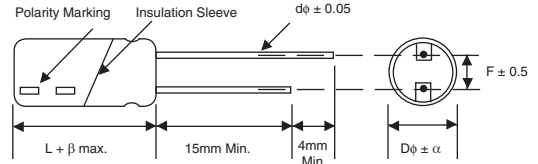

Drawing is representative of parts as supplied in bulk or straight lead format, please see taping specification for details on taped format packaging.

### STANDARD PRODUCTS, CASE SIZES AND SPECIFICATIONS

Part Number	Cap. (μF)	W.V. (Vdc)	Max. Tan $\delta$	Max. LC (μA)	Max. Impedance		Max. Ripple Current at 100KHz/105°C (mA rms)	Load Life Hours @ +105°C
					100KHz/20°C	100KHz/-10°C		
NRSZ101M6.3V5x11F	100	6.3	0.22	6.3	0.90	1.8	100	2,000
NRSZ221M6.3V6.3x11F	220		0.22	13.9	0.30	0.60	280	2,000
NRSZ331M6.3V6.3x11F	330		0.22	20.8	0.22	0.44	300	2,000
NRSZ331M6.3V8x11.5F			0.22	20.8	0.19	0.38	410	3,000
NRSZ471M6.3V8x11.5F	470		0.22	296	0.11	0.22	560	3,000
NRSZ681M6.3V8x15F	680		0.22	42.8	0.985	0.17	730	3,000
NRSZ821M6.3V10x12.5F	820		0.22	51.7	0.085	0.17	800	3,000
NRSZ102M6.3V8x20F	1000		0.22	63.0	0.069	0.14	800	3,000
NRSZ122M6.3V10x16F	1200		0.22	75.6	0.062	0.13	1050	3,000
NRSZ152M6.3V10x20F	1500		0.23	94.5	0.044	0.088	1250	5,000
NRSZ152M6.3V12.5x16F			0.23	94.5	0.063	0.14	1150	5,000
NRSZ222M6.3V12.5x20F	2200		0.24	138	0.048	0.096	1400	5,000
NRSZ272M6.3V12.5x20F	2700		0.25	170	0.038	0.076	1600	5,000
NRSZ392M6.3V12.5x25F	3900		0.28	245	0.029	0.058	1800	5,000
NRSZ472M6.3V12.5x25F	4700		0.29	296	0.029	0.058	1800	5,000
NRSZ562M6.3V16x25F	5600		0.31	353	0.022	0.044	2100	5,000
NRSZ123M6.3V18x35.5F	12000		0.44	756	0.018	0.036	2800	5,000
NRSZ680M10V5x11F	68		10	0.19	6.8	0.90	1.8	160
NRSZ820M10V5x11F	82	0.19		8.2	0.65	1.3	175	2,000
NRSZ101M10V5x11F	100	0.19		10.0	0.42	0.84	190	2,000
NRSZ151M10V6.3x11F	150	0.19		150.0	0.31	0.62	280	2,000
NRSZ181M10V6.3x11F	180	0.19		18.0	0.31	0.62	280	2,000
NRSZ221M10V6.3x11F	220	0.19		22.0	0.22	0.44	300	2,000
NRSZ331M10V8x11.5F	330	0.19		33.0	0.11	0.28	560	3,000
NRSZ471M10V8x15F	470	0.19		47.0	0.085	0.17	610	3,000
NRSZ471M10V10x12.5F		0.19		47.0	0.12	0.24	730	3,000
NRSZ561M10V10x16F	560	0.19		56.0	0.095	0.19	735	3,000
NRSZ681M10V8x20F	680	0.19		68.0	0.069	0.14	800	3,000
NRSZ681M10V10x12.5F		0.19		68.0	0.085	0.17	800	3,000
NRSZ102M10V10x20F	1000	0.19		100	0.050	0.10	1200	3,000
NRSZ102M10V12.5x16F		0.19		100	0.063	0.14	1150	5,000
NRSZ122M10V10x20F	1200	0.19		120	0.044	0.088	1250	3,000
NRSZ152M10V10x22F	1500	0.20		150	0.039	0.078	1450	3,000
NRSZ222M10V12.5x20F	2200	0.22		220	0.038	0.076	1400	5,000
NRSZ222M10V12.5x25F		0.22		220	0.037	0.074	1700	5,000
NRSZ272M10V12.5x25F	2700	0.22	270	0.029	0.058	1800	5,000	
NRSZ332M10V12.5x25F	3300	0.23	330	0.035	0.070	1700	5,000	
NRSZ392M10V16x25F	3900	0.25	390	0.028	0.056	2070	5,000	
NRSZ472M10V16x31.5F	4700	0.26	470	0.024	0.048	2350	5,000	
NRSZ562M10V16x31.5F	5600	0.18	560	0.024	0.048	2350	5,000	
NRSZ682M10V16x35.5F	6800	0.30	680	0.022	0.044	2550	5,000	
NRSZ822M10V18x35.5F	8200	0.33	820	0.020	0.040	2800	5,000	

### STANDARD PRODUCTS, CASE SIZES AND SPECIFICATIONS

Part Number	Cap. (μF)	W.V. (Vdc)	Max. Tanδ	Max. LC (μA)	Max. Impedance		Max. Ripple Current at 100KHz/105°C (mA rms)	Load Life Hours @ +105°C
					100KHz/20°C	100KHz/-10°C		
NRSZ470M16V5x11F	47	16	0.16	7.5	0.90	1.8	180	2,000
NRSZ560M16V5x11F	56		0.16	9.0	0.90	1.8	180	2,000
NRSZ101M16V6.3x11F	100		0.16	16.0	0.32	0.64	280	2,000
NRSZ121M16V6.3x11F	120		0.16	19.2	0.31	0.62	290	2,000
NRSZ151M16V6.3x11F	150		0.16	24.0	0.22	0.44	300	2,000
NRSZ181M16V6.3x11F	180		0.16	28.8	0.24	0.48	280	2,000
NRSZ221M16V8x11.5F	220		0.16	35.2	0.11	0.32	560	3,000
NRSZ271M16V8x12.5F	270		0.16	43.2	0.11	0.28	570	3,000
NRSZ331M16V8x15F	330		0.16	52.8	0.085	0.17	730	3,000
NRSZ331M16V10x12.5F			0.16	52.8	0.10	0.20	650	3,000
NRSZ471M16V8x20F	470		0.16	75.2	0.069	0.14	800	3,000
NRSZ471M16V10x16F			0.16	75.2	0.90	0.18	950	3,000
NRSZ681M16V10x20F	680		0.16	108	0.054	0.11	1250	3,000
NRSZ681M16V12.5x16F			0.16	108	0.063	0.14	1150	5,000
NRSZ821M16V10x20F	820		0.16	131	0.044	0.90	1250	3,000
NRSZ102M16V10x22F	1000		0.16	160	0.039	0.078	1450	3,000
NRSZ122M16V12.5x20F	1200		0.16	192	0.038	0.076	1600	5,000
NRSZ182M16V12.5x25F	1800		0.17	288	0.029	0.058	1800	5,000
NRSZ222M16V12.5x25F	2200		0.18	352	0.037	0.074	1700	5,000
NRSZ222M16V16x21F			0.18	352	0.040	0.080	1700	5,000
NRSZ272M16V16x25F	2700		0.19	432	0.022	0.044	2100	5,000
NRSZ392M16V16x31.5F	3900		0.22	624	0.018	0.036	2350	5,000
NRSZ472M16V16x35.5F	4700		0.23	752	0.018	0.036	2550	5,000
NRSZ562M16V18x35.5F	5600		0.25	896	0.018	0.036	2800	5,000
NRSZ330M25V5x11F	33	25	0.14	8.3	0.90	1.8	160	2,000
NRSZ470M25V5x11F	47		0.14	11.7	0.42	0.84	190	2,000
NRSZ680M25V6.3x11F	68		0.14	17.0	0.32	0.64	280	2,000
NRSZ101M25V6.3x11F	100		0.14	25.0	0.22	0.48	300	2,000
NRSZ151M25V8x11.5F	150		0.14	37.5	0.11	0.22	560	3,000
NRSZ181M25V8x12.5F	180		0.14	45.0	0.11	0.22	570	3,000
NRSZ221M25V8x15F	220		0.14	55.0	0.085	0.18	730	3,000
NRSZ221M25V10x12.5F			0.14	55.0	0.12	0.24	630	3,000
NRSZ271M25V10x12.5F	270		0.14	67.5	0.085	0.18	800	3,000
NRSZ331M25V8x20F	330		0.14	82.5	0.069	0.16	800	3,000
NRSZ331M25V10x16F			0.14	82.5	0.090	0.18	830	3,000
NRSZ471M25V10x16F	470		0.14	117	0.065	0.13	1010	3,000
NRSZ471M25V12.5x16F			0.14	117	0.063	0.14	1150	5,000
NRSZ561M25V10x20F	560		0.14	140	0.044	0.088	1250	3,000
NRSZ681M25V10x22F	680		0.14	170	0.039	0.078	1450	3,000
NRSZ102M25V12.5x20F	1000		0.14	250	0.038	0.076	1600	5,000
NRSZ102M25V16x16F			0.14	250	0.038	0.076	1600	5,000
NRSZ122M25V12.5x25F	1200		0.14	300	0.029	0.058	1800	5,000
NRSZ182M25V16x25F	1800		0.15	450	0.022	0.044	2100	5,000
NRSZ222M25V16x25F	2200		0.16	550	0.029	0.058	2000	5,000
NRSZ272M25V16x31.5F	2700		0.17	675	0.018	0.038	2350	5,000
NRSZ332M25V18x35.5F	3300		0.18	825	0.018	0.038	2550	5,000
NRSZ392M25V18x31.5F	3900		0.20	975	0.018	0.046	2800	5,000
NRSZ472M25V18x35.5F	4700		0.21	1175	0.021	0.042	2700	5,000

### STANDARD PRODUCTS, CASE SIZES AND SPECIFICATIONS

Part Number	Cap. (μF)	W.V. (Vdc)	Max. Tanδ	Max. LC (μA)	Max. Impedance		Max. Ripple Current at 100KHz/105°C (mA rms)	Load Life Hours @ +105°C	
					100KHz/20°C	100KHz/-10°C			
NRSZ220M35V5x11F	22	35	0.12	7.7	0.42	0.84	190	2,000	
NRSZ330M35V6.3x11F	33		0.12	11.6	0.42	0.84	190	2,000	
NRSZ470M35V6.3x11F	47		0.12	16.5	0.32	0.64	280	2,000	
NRSZ680M35V6.3x11F	68		0.12	19.6	0.22	0.44	300	2,000	
NRSZ820M35V6.3x11F	82		0.12	28.7	0.24	0.48	280	2,000	
NRSZ101M35V8x11.5F	100		0.12	35.0	0.11	0.22	560	3,000	
NRSZ121M35V8x12.5F	120		0.12	42.0	0.11	0.22	570	3,000	
NRSZ121M35V10x12.5F			0.14	42.0	0.14	0.28	560	3,000	
NRSZ151M35V8x15F	150		0.12	52.5	0.085	0.17	730	3,000	
NRSZ151M35V10x12.5F			0.12	52.5	0.12	0.24	635	3,000	
NRSZ221M35V8x20F	220		0.12	77.0	0.069	0.14	800	3,000	
NRSZ221M35V10x16F			0.12	77.0	0.085	0.17	950	3,000	
NRSZ331M35V10x20F	330		0.12	115	0.044	0.088	1250	3,000	
NRSZ331M35V12.5x16F			0.12	115	0.063	0.14	1150	5,000	
NRSZ391M35V10x20F	390		0.12	136	0.054	0.11	1190	3,000	
NRSZ471M35V10x20F	470		0.12	164	0.054	0.11	1250	3,000	
NRSZ561M35V12.5x20F	560		0.12	196	0.042	0.084	1400	5,000	
NRSZ681M35V12.5x20F	680		0.12	238	0.038	0.076	1600	5,000	
NRSZ102M35V12.5x25F	1000		0.12	350	0.029	0.058	1800	5,000	
NRSZ102M35V16x21F			0.12	350	0.037	0.074	1700	5,000	
NRSZ122M35V16x25F	1200		0.12	420	0.029	0.058	2000	5,000	
NRSZ152M35V16x25F	1500		0.13	525	0.022	0.044	2100	5,000	
NRSZ222M35V16x31.5F	2200		0.14	770	0.018	0.036	2350	5,000	
NRSZ222M35V16x35.5F			0.14	770	0.018	0.036	2550	5,000	
NRSZ272M35V18x35.5F	2700		0.15	945	0.018	0.036	2800	5,000	
NRSZ332M35V18x35.5F	3300		0.16	1155	0.022	0.044	2700	5,000	
NRSZ1R0M50V5x11F	1.0		50	0.10	3.0	3.3	6.6	30	2,000
NRSZ2R2M50V5x11F	2.2			0.10	3.0	3.0	6.0	45	2,000
NRSZ4R7M50V5x11F	4.7			0.10	3.0	2.0	4.0	90	2,000
NRSZ100M50V5x11F	10			0.10	5.0	1.7	3.4	110	2,000
NRSZ150M50V5x11F	15			0.10	7.5	1.2	2.4	130	2,000
NRSZ180M50V5x11F	18			0.10	9.0	1.0	2.0	150	2,000
NRSZ220M50V5x11F	22			0.10	11.0	0.70	1.4	160	2,000
NRSZ330M50V6.3x11F	33	0.10		16.5	0.55	1.1	200	2,000	
NRSZ390M50V6.3x11F	39	0.10		19.5	0.55	1.1	200	2,000	
NRSZ470M50V6.3x11F	47	0.10		23.5	0.43	0.86	220	2,000	
NRSZ680M50V8x11.5F	68	0.10		34.0	0.26	0.52	360	3,000	
NRSZ820M50V8x12.5F	82	0.10		41.0	0.24	0.48	400	3,000	
NRSZ101M50V8x15F	100	0.10		50.0	0.18	0.36	500	3,000	
NRSZ101M50V10x12.5F		0.10		50.0	0.25	0.50	520	3,000	
NRSZ121M50V8x20F	120	0.10		60.0	0.16	0.32	650	3,000	
NRSZ121M50V10x12.5F		0.10		60.0	0.16	0.32	550	3,000	
NRSZ151M50V8x20F	150	0.10		75.0	0.16	0.32	650	3,000	
NRSZ181M50V10x16F	180	0.10		90.0	0.12	0.24	760	3,000	
NRSZ221M50V10x20F	220	0.10		110	0.10	0.20	850	3,000	
NRSZ221M50V12.5x16F	220	0.10		110	0.12	0.24	800	5,000	
NRSZ331M50V10x22F	330	0.10		165	0.072	0.16	1000	3,000	
NRSZ391M50V12.5x20F	390	0.10		195	0.059	0.12	1200	5,000	
NRSZ391M50V16x16F		0.10		195	0.08	0.16	1610	5,000	
NRSZ471M50V12.5x20F	470	0.10		235	0.059	0.12	1200	5,000	
NRSZ471M50V16x16F		0.10		235	0.07	0.14	1200	5,000	
NRSZ561M50V12.5x25F	560	0.10		280	0.045	0.092	1400	5,000	
NRSZ102M50V16x25F	1000	0.10		500	0.039	0.078	1750	5,000	
NRSZ122M50V16x31.5F	1200	0.10		600	0.025	0.058	2100	5,000	
NRSZ152M50V16x35.5F	1500	0.11		750	0.025	0.058	2300	5,000	
NRSZ182M50V18x35.5F	1800	0.11		900	0.024	0.048	2400	5,000	



### STANDARD PRODUCTS, CASE SIZES AND SPECIFICATIONS

Part Number	Cap. (μF)	W.V. (Vdc)	Max. Tanδ	Max. LC (μA)	Max. Impedance		Max. Ripple Current at 100KHz/105°C (mA rms)	Load Life Hours @ +105°C
					100KHz/20°C	100KHz/-10°C		
NRSZ180M63V5x11F	18	63	0.08	7.6	1.6	3.2	140	2,000
NRSZ220M63V6.3x11F	33		0.08	17.0	0.90	1.8	200	2,000
NRSZ390M63V6.3x11F	39		0.08	24.6	0.90	1.8	200	2,000
NRSZ470M63V8x11.5F	47		0.08	29.6	0.52	1.04	275	3,000
NRSZ560M63V8x11.5F	56		0.08	35.3	0.52	1.04	275	3,000
NRSZ680M63V8x11.5F	68		0.08	42.8	0.52	1.04	275	3,000
NRSZ820M63V8x15F	82		0.08	51.7	0.34	0.68	360	3,000
NRSZ101M63V10x12.5F	100		0.08	63.0	0.26	0.52	420	3,000
NRSZ121M63V8x20F	120		0.08	75.6	0.21	0.42	510	3,000
NRSZ121M63V10x12.5F			0.08	75.6	0.26	0.52	420	3,000
NRSZ151M63V8x20F	150		0.08	94.5	0.18	0.36	690	3,000
NRSZ151M63V10x16F			0.08	91.5	0.20	0.40	525	3,000
NRSZ221M63V10x20F			0.08	138	0.15	0.30	765	3,000
NRSZ271M63V10x22F			0.08	170	0.12	0.24	840	3,000
NRSZ331M63V12.5x20F	330		0.08	208	0.10	0.20	960	5,000
NRSZ391M63V12.5x25F	390		0.08	245	0.064	0.13	1200	5,000
NRSZ471M63V12.5x25F	470		0.08	296	0.064	0.13	1200	5,000
NRSZ681M63V16x25F	680		0.08	428	0.052	0.11	1500	5,000
NRSZ102M63V16x31.5F	1000		0.08	630	0.042	0.09	1750	5,000
NRSZ1R0M100V5x11F	1.0		100	0.07	3.0	4.1	8.2	97
NRSZ5R6M100V5x11F	5.6	0.07		5.6	2.7	5.4	120	2,000
NRSZ100M100V6.3x11F	10	0.07		10	1.4	2.8	120	2,000
NRSZ120M100V6.3x11F	12	0.07		12	1.4	2.8	170	2,000
NRSZ150M100V8x11.5F	15	0.07		15	0.81	1.62	230	3,000
NRSZ220M100V8x11.5F	22	0.07		22	0.81	1.62	230	3,000
NRSZ270M100V8x15F	27	0.07		27	0.64	1.3	295	3,000
NRSZ390M100V8x20F	39	0.07		39	0.36	0.72	400	3,000
NRSZ470M100V10x16F	47	0.07		47	0.35	0.70	420	3,000
NRSZ680M100V10x20F	68	0.07		68	0.24	0.48	630	3,000
NRSZ101M100V12.5x20F	100	0.07		100	0.15	0.30	800	5,000
NRSZ151M100V12.5x25F	150	0.07		150	0.11	0.22	920	5,000
NRSZ221M100V16x25F	220	0.07		220	0.071	0.15	1100	5,000
NRSZ331M100V16x31.5F	330	0.07		330	0.049	0.10	1490	5,000
NRSZ391M100V16x35.5F	390	0.07		390	0.043	0.09	1630	5,000
NRSZ471M100V18x35.5F	470	0.07		470	0.038	0.08	1700	5,000

### PART NUMBERING SYSTEM

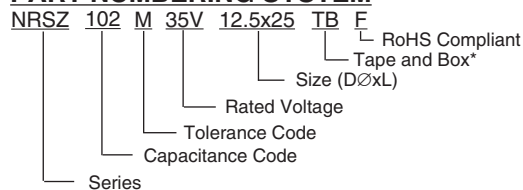

\*see tape specification for details

# Miniature Aluminum Electrolytic Capacitors Taping Specifications

## STANDARD RADIAL TAPING (5mm LEAD SPACING, FORMED LEADS) TR, TB

Taping Dimensions (mm)

Case Dia. (D $\phi$ )	4	5	6.3	8
Case Size	4x5	5x5	6.3x5	8x11.5
Dim.	4x7	5x7	6.3x7	6.3x11
d $\phi$ $\pm$ 0.05	0.45	0.45	0.5	0.5
H $\pm$ 0.75	17.5	17.5	18.5	18.5
F +0.8 ~ -0.2	5.0 -0.2 ~ +0.8			
P	12.7 $\pm$ 1.0			
P <sub>0</sub>	12.7 $\pm$ 0.2			
P <sub>1</sub>	3.85 $\pm$ 0.5 (at end of tape)			
P <sub>2</sub>	6.35 $\pm$ 1.0			
W	18.0 $\pm$ 0.5			
W <sub>0</sub>	11.5 min.			
W <sub>1</sub>	9.0 $\pm$ 0.5			
W <sub>2</sub>	0 ~ 2.5			
H <sub>0</sub>	16.0 $\pm$ 0.5			
l	1.0 max.			
D <sub>0</sub> $\phi$	4.0 $\pm$ 0.2			
$\Delta$ h	0 $\pm$ 1.0 (at top of can)			
t	0.7 $\pm$ 0.2 (not including lead)			

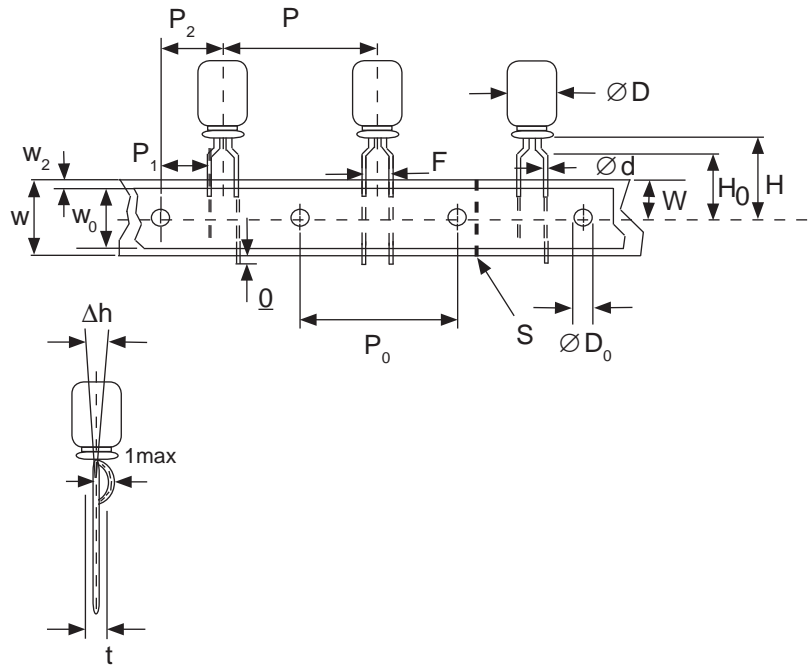

## STANDARD RADIAL TAPING (5mm LEAD SPACING, STRAIGHT LEADS) TR, TB

Taping Dimensions (mm)

Case Dia. (D $\phi$ )	10	12.5
Case Size	All	All
Dim.	All	All
d $\phi$ $\pm$ 0.05	0.6	0.6
H $\pm$ 0.75	19.0	19.0
F +0.8 ~ -0.2	5.0	5.0
P $\pm$ 1.0	25.4*	
P <sub>0</sub>	12.7 $\pm$ 0.2	
P <sub>1</sub>	3.85	
P <sub>2</sub>	6.35 $\pm$ 1.0	
W	18.0 $\pm$ 0.5	
W <sub>0</sub>	11.5 min	
W <sub>1</sub>	9.0 $\pm$ 0.5	
W <sub>2</sub>	0 ~ 2.5	
H <sub>0</sub>	16.0 $\pm$ 0.5	
l	1.0 max.	
D <sub>0</sub> $\phi$	4.0 $\pm$ 0.2	
$\Delta$ h	0 $\pm$ 1.0 (at top of can)	
t	0.7 $\pm$ 0.2 (not including lead)	

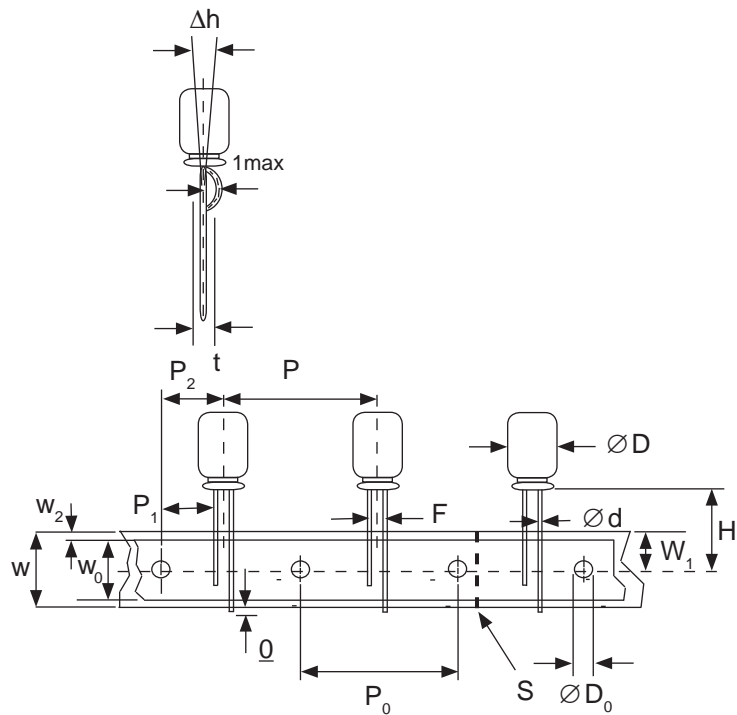

### \*Optional Taping Specifications

10mm diameter available with P dim. = 12.7mm  
(P/N Suffix: TB12.7MMP)

12.5mm diameter available with P dim. = 15mm, P<sub>1</sub> = 5.0mm,  
P<sub>0</sub> = 15.0mm & P<sub>2</sub> = 7.5mm (P/N Suffix: TB15MMP)

**NOTE:** ANODE (+) LEAD FEEDS OFF FIRST.  
FOR OPTION OF NEGATIVE (-) LEAD FIRST,  
SPECIFY "TRN" OR "TBN".



# Miniature Aluminum Electrolytic Capacitors Taping Specifications

## SPECIAL RADIAL TAPING (2.5mm LEAD SPACING, FORMED LEADS) TRF1, TBF1

Taping Dimensions (mm)

Case Dia. (D $\phi$ )	4		5	
Case Size Dim.	4x5 4x7	5x5 5x7	5x11	
d $\phi$ $\pm$ 0.05	0.45	0.45	0.5	
H $\pm$ 0.75	17.5	17.5	18.5	
H <sub>0</sub> $\pm$ 0.5	16.0	-	-	
F	2.5 -0.2 ~ +0.8			
P	12.7 $\pm$ 1.0			
P <sub>0</sub>	12.7 $\pm$ 0.2			
P <sub>1</sub>	5.1 $\pm$ 0.5			
P <sub>2</sub>	6.35 $\pm$ 1.0			
W	18.0 $\pm$ 0.5			
W <sub>0</sub>	11.5 min.			
W <sub>1</sub>	9.0 $\pm$ 0.5			
W <sub>2</sub>	0 ~ 1.5			
l	1.0 max.			
D <sub>0</sub> $\phi$	4.0 $\pm$ 0.2			
$\Delta$ h	0 $\pm$ 1.0			
t	0.7 $\pm$ 0.2			

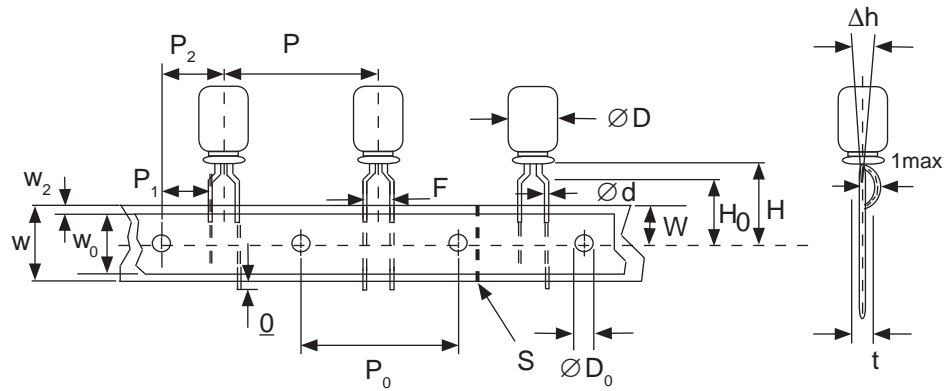

## SPECIAL STRAIGHT LEAD TAPING TRST, TBST

Taping Dimensions (mm)

Case Dia. (D $\phi$ )	4			5			6.3		8	
Case Size Dim.	4x5 4x7	5x5 5x7	5x11		6.3x5 6.3x7	6.3x11	8x11.5			
d $\phi$ $\pm$ 0.05	0.45	0.45	0.5		0.45	0.5	0.6			
H $\pm$ 0.75	17.5	17.5	18.5		17.5	18.5	20.0			
F +0.8 ~ -0.2	2.0*	2.0	2.0		2.5	2.5	3.5			
P $\pm$ 1.0	12.7 $\pm$ 0.2									
P <sub>0</sub>	12.7 $\pm$ 0.2									
P <sub>1</sub>	5.1	5.1	5.1	5.1	5.1	5.1	4.6			
P <sub>2</sub>	6.35 $\pm$ 1.0									
W	18.0 $\pm$ 0.5									
W <sub>0</sub>	11.5 min.									
W <sub>1</sub>	9.0 $\pm$ 0.5									
W <sub>2</sub>	0 ~ 2.5									
H <sub>0</sub>	16.0 $\pm$ 0.5									
l	1.0 max.									
D <sub>0</sub> $\phi$	4.0 $\pm$ 0.2									
$\Delta$ h	0 $\pm$ 1.0 (at top of can)									
t	0.7 $\pm$ 0.2 (not including lead)									

\* Parts with 4mm diameter are taped with a slight flare in the lead and a 2.0mm lead-space.

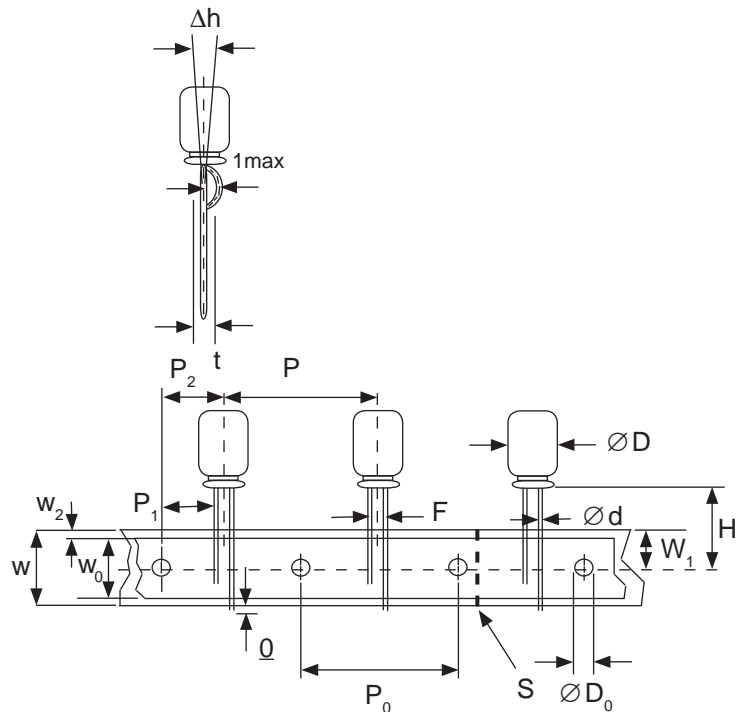

# Miniature Aluminum Electrolytic Capacitors Taping Specifications

## RADIAL TAPED PACKAGING

Ammo Box (Tape & Box) TB, TBF, TBST

Size of box and component quantity

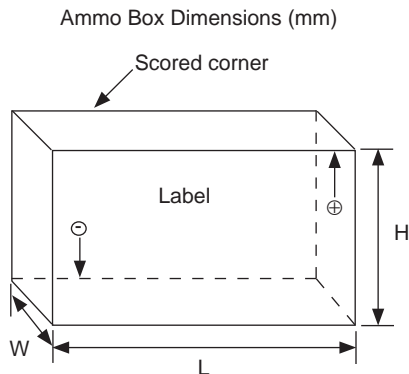

Case Dia (D $\phi$ ) or Case Size	Q'ty per Box (pcs)	Dim. L	Dim. H	Dim. W
4x5, 4x7	2,000	331	175	43
5x5, 5x7	2,000	331	220	43
5x11	2,000	340	255	55
6.3x5, 6.3x7	2,000	331	280	43
6.3x11	2,000	331	280	48
8x11.5, 8x12.5	1,000	335	235	53
10x12.5*	500	335	190	53
10x16*	500	335	300	53
10x20*	500	335	300	55
12.x20*	500	335	300	55
12.5x25*	500	335	300	61

\*Special Taping Consult Factory For Availability

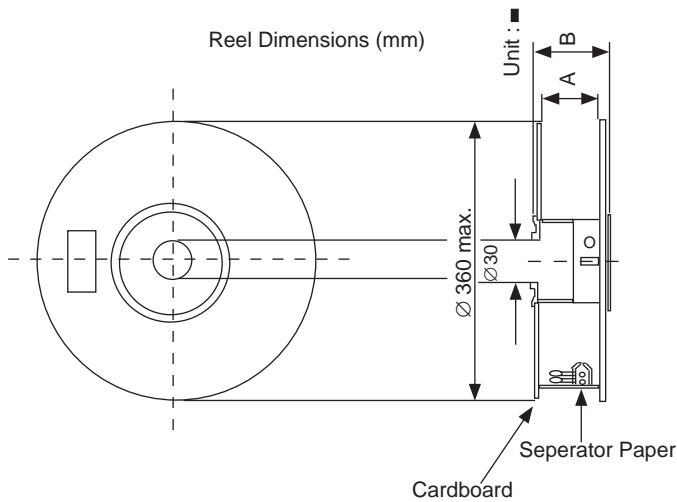

Reel Packages (Tape & Reel) TR, TRF1, TRST

Size of reel and component quantity

Case Dia (D $\phi$ ) or Case Size	Q'ty per Box (pcs)	Dim. A	Dim. B
4 $\phi$	1,800	42	52
5 $\phi$	1,500	42	52
6.3 $\phi$	1,000	42	52
8 $\phi$	800	42	52
10x12.5*	600	42	52
10x16*	600	48	56
10x20*	600	52	60
12.x20*	250	52	60
12.5x25*	250	56	64

\*Special Taping Consult Factory For Availability

