

No. OF PINS	DIMENSIONS				
	A	B	C	D MAX	E
9	0.780	1.350	0.395	0.228	0.338
	19.81	34.29	10.03	5.79	8.59
15	0.932	1.367	0.360	0.284	0.338
	23.67	34.72	9.14	7.21	8.59
25	1.195	1.373	0.390	0.331	0.390
	30.35	34.87	9.91	8.41	9.91

BACKSHELL KIT INCLUDES:

- 1 - BACKSHELL ⑤
- 1 - ALIGNMENT SLEEVE ①
- 1 - COVER ②
- 1 - INSULATOR (FRONT) ③
- 1 - INSULATOR (REAR) ④
- 2 - 2-56 JACKSCREW ⑥

MATERIAL:

- BACKSHELL: THERMOPLASTIC
- ALIGNMENT SLEEVE: STEEL, TIN PLATED
- COVER: STEEL, TIN PLATED
- INSULATOR (FRONT): THERMOPLASTIC
- INSULATOR (REAR): THERMOPLASTIC
- JACKSCREW: STEEL, NICKEL PLATED

MECHANICAL:

- OPERATING TEMP: -10° C TO + 70° c
- MATING CYCLES: 300 CYCLES

960-YYY-010R01Y

1 = KIT
2 = BULK

009 = 9 POSITION
015 = 15 POSITION
025 = 25 POSITION

DO NOT SCALE FROM DRAWING



THESE DRAWINGS AND SPECIFICATIONS ARE THE PROPERTY OF NorComp AND SHALL NOT BE REPRODUCED, COPIED OR USED AS THE BASIS FOR THE MANUFACTURE OF SALE OF APPARATUS WITHOUT WRITTEN PERMISSION.

DRAWN: M. SIGMON

DATE: 09-01-11

NorComp

SCALE: NTS SHEET 1 OF 2 REV 4

DWG NO. 960-YYY-010R01Y

RoHS COMPLIANT

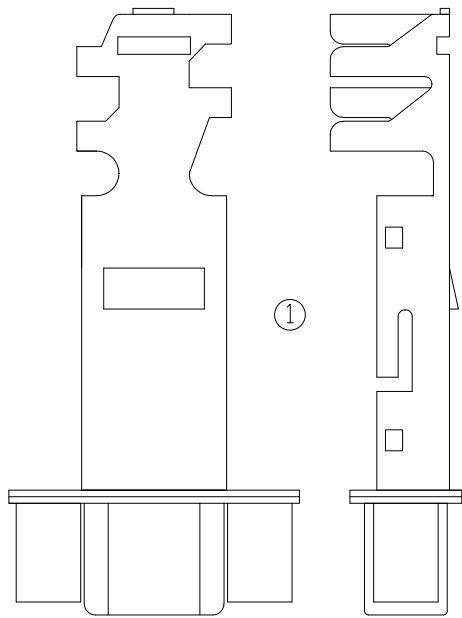

**ALIGNMENT SLEEVE
(LOWER SHIELD)**

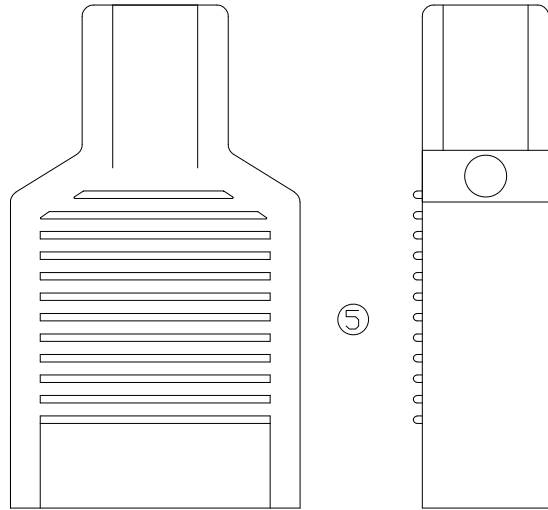

BACKSHELL

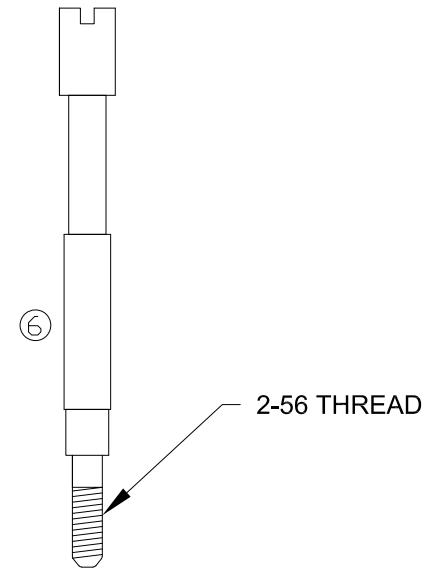

JACKSCREW(2)

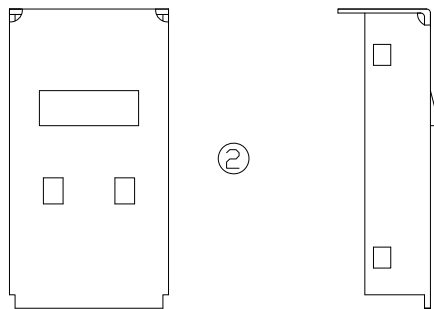

COVER (UPPER SHIELD)

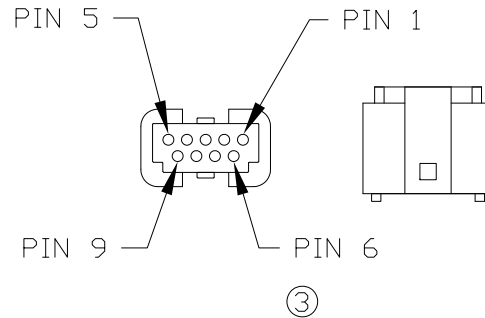

INSULATOR (FRONT)

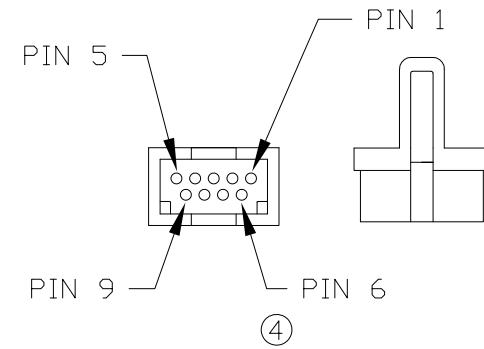

INSULATOR (REAR)

DO NOT SCALE FROM DRAWING

RoHS COMPLIANT

	THESE DRAWINGS AND SPECIFICATIONS ARE THE PROPERTY OF NorComp AND SHALL NOT BE REPRODUCED, COPIED OR USED AS THE BASIS FOR THE MANUFACTURE OF SALE OF APPARATUS WITHOUT WRITTEN PERMISSION.		DRAWN: M. SIGMON	DATE: 09-01-11
	NorComp		SCALE: NTS	SHEET 2 OF 2
DWG NO. 960-YYY-010R01Y				