

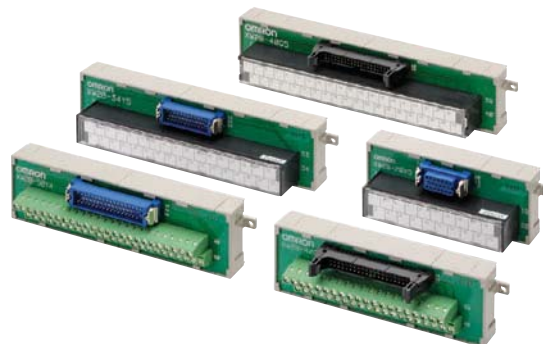





Simplifies Connector and terminal block replacement, and requires less in-panel wiring.

- Mount to DIN Track or via screws.
- MIL Flat Cable Connectors and Multi-pole, Square Connectors are standard.
- Terminal blocks available with either M3 or M3.5 screws.
- Connecting Cables for Programmable Controllers available (sold separately).

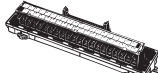
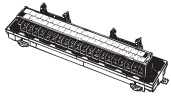
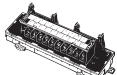

Ordering Information

Connectors

Type	Terminal Block	Connector	No. of poles	Appearance	Model
Flat Cable	Terminal block with M3 screws	Flat Cable Connectors *1	20		XW2B-20G4
			34		XW2B-34G4
			40		XW2B-40G4
			50		XW2B-50G4
			60		XW2B-60G4
	Terminal block with M3.5 screws		20		XW2B-20G5
			34		XW2B-34G5
			40		XW2B-40G5
			50		XW2B-50G5
			60		XW2B-60G5
Twin-connector	Terminal block with M3.5 screws	Flat Cable Connectors *1	40		XW2B-40G5-T
Daisy Chain			20		XW2B-20G5-D
Multi-pole, Square Connector	Terminal block with M3 screws	Multi-pole, Square Connector Plugs *2	20		XW2B-20Y4
			34		XW2B-34Y4
			50		XW2B-50Y4
	Terminal block with M3.5 screws		20		XW2B-20Y5
			34		XW2B-34Y5
			50		XW2B-50Y5
	Terminal block with M3.5 screws	Multi-pole, Square Connector Plugs *2	20		XW2B-20X5
			34		XW2B-34X5
			50		XW2B-50X5
Board I/O	Terminal block with M3.5 screws	Multi-pole, Square Connector Plugs *3	40		XW2B-40F5-P

*1. Flat Cable Connectors have one polarity slot.

*2. These Plugs and Sockets are made by Honda Tsushin Kogyo.

*3. These Plugs are made by Fujitsu.

Accessories (Order Separately)

Connecting Cables for Connector-Terminal Block Conversion Units

For details on the Connecting Cable used between XW2B Daisy Chain-type Connectors, refer to the *XW2Z datasheet*.

Ratings and Specifications

Item	Type	XW2B-□□G□ Flat Cable Units	XW2B-□□Y□ Multi-pole, Square-connector Units	XW2B-40F5-P Board I/O Unit
Rated current		1 A		
Rated voltage		125 VAC		
Insulation resistance		100 MΩ min. (at 500 VDC)		
Dielectric strength		500 VAC for 1 min (leakage current: 1 mA max.)		
Ambient operating temperature		0 to 55°C		

Dimensions

(Unit: mm)

Flat Cable Units with a Terminal Block with M3 Screws

XW2B-□□G4

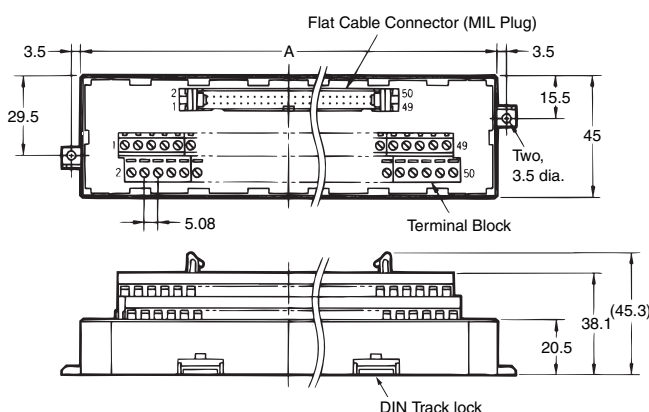
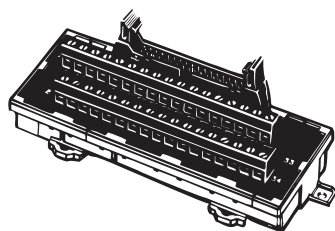

Wiring Diagram

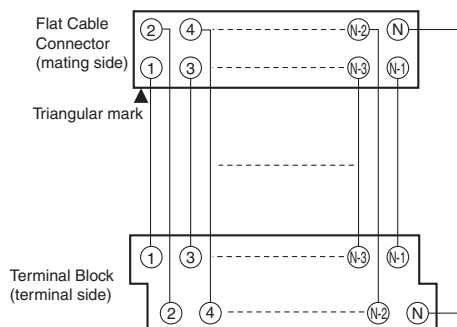

Note: All pins on the Flat Cable Connector correspond 1-to-1 to the terminal of the same number on the terminal block as shown above.

Dimensions

Model	No. of poles	Dimension A (mm)	Applicable Connector models *1
XW2B-20G4	20	67.5	XG4A-2031
XW2B-34G4	34	112.5	XG4A-3431
XW2B-40G4	40	135.0	XG4A-4031
XW2B-50G4	50	157.5	XG4A-5031
XW2B-60G4	60	180.0	XG4A-6031

*Flat Cable Connectors have one polarity slot.

Note: Terminal block pitch is 5.08 mm.

Use a wire size between 0.3 and 1.25 mm² (AWG22 to AWG16).

The wire insertion holes are 1.8 × 2.5 (H × W) mm.

Applicable Connectors

Model	Applicable Connectors (order separately)		
	Flat Cable Connectors, MIL Sockets with Strain Reliefs	Discrete-wire IDC Connectors, Double-row Sockets	
		Connectors *1	Semi-covers *2
XW2B-20G4	XG4M-2030-T	XG5M-2032-N XG5M-2035-N	XG5S-1001
XW2B-34G4	XG4M-3430-T	XG5M-3432-N XG5M-3435-N	XG5S-1701
XW2B-40G4	XG4M-4030-T	XG5M-4032-N XG5M-4035-N	XG5S-2001
XW2B-50G4	XG4M-5030-T	XG5M-5032-N XG5M-5035-N	XG5S-2501
XW2B-60G4	XG4M-6030-T	XG5M-6032-N XG5M-6035-N	XG5S-3001

*1. Either the XG5M-□□32-N or the XG5M-□□35-N may be used.

*2. Each Connector requires two Semi-covers.

Flat Cable Units with a Terminal Block with M3.5 Screws

XW2B-□□G5

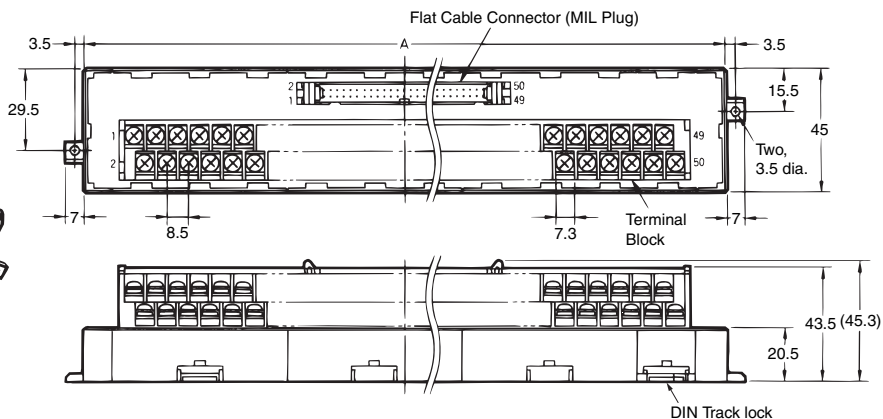
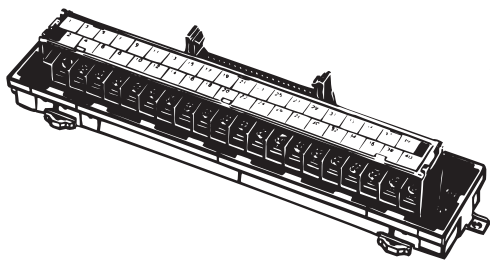

Wiring Diagram

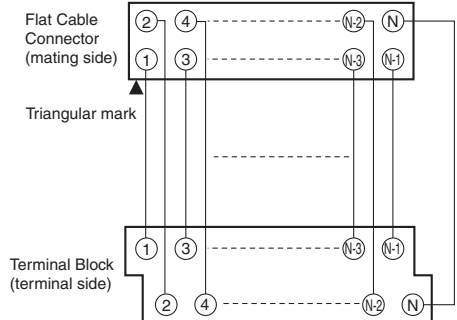

Note: All pins on the Flat Cable Connector correspond 1-to-1 to the terminal of the same number on the terminal block as shown above.

Dimensions

Model	No. of poles	Dimension A (mm)	Applicable Connector models *
XW2B-20G5	20	112.5	XG4A-2031
XW2B-34G5	34	180.0	XG4A-3431
XW2B-40G5	40	202.5	XG4A-4031
XW2B-50G5	50	247.5	XG4A-5031
XW2B-60G5	60	292.5	XG4A-6031

*Flat Cable Connectors have one polarity slot.
Note: Terminal block pitch is 8.5 mm.

Applicable Connectors

Model	Applicable Connectors (order separately)		
	Flat Cable Connectors, MIL Sockets with Strain Reliefs	Discrete-wire IDC Connectors, Double-row Sockets	
		Connectors *1	Semi-covers *2
XW2B-20G5	XG4M-2030-T	XG5M-2032-N XG5M-2035-N	XG5S-1001
XW2B-34G5	XG4M-3430-T	XG5M-3432-N XG5M-3435-N	XG5S-1701
XW2B-40G5	XG4M-4030-T	XG5M-4032-N XG5M-4035-N	XG5S-2001
XW2B-50G5	XG4M-5030-T	XG5M-5032-N XG5M-5035-N	XG5S-2501
XW2B-60G5	XG4M-6030-T	XG5M-6032-N XG5M-6035-N	XG5S-3001

*1. Either the XG5M-□□32-N or the XG5M-□□35-N may be used.
*2. Each Connector requires two Semi-covers.

Twin-connector Units with a Terminal Block with M3.5 Screws

XW2B-40G5-T

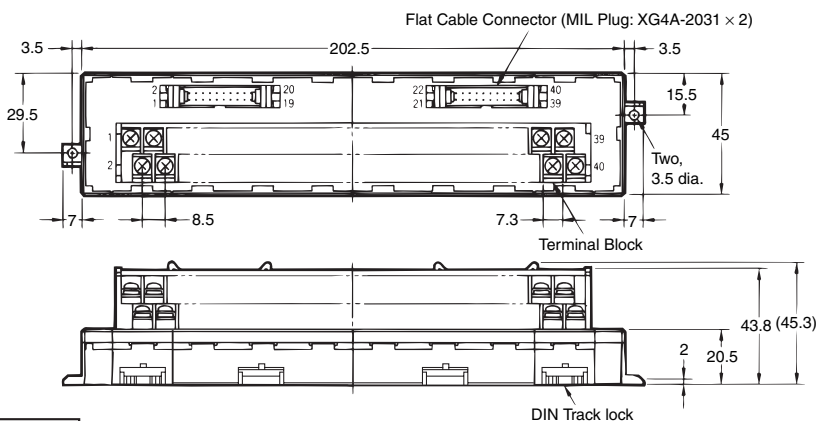
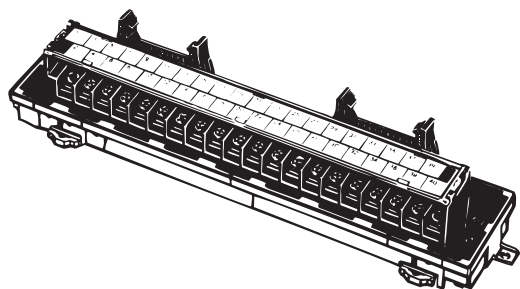

Wiring Diagram

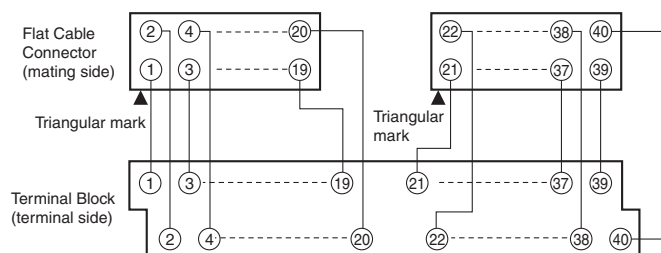

Note: All pins on the Flat Cable Connector correspond 1-to-1 to the terminal of the same number on the terminal block as shown above.

Applicable Connectors

Model	Applicable Connectors (order separately)		
	Flat Cable Connectors, MIL Sockets with Strain Reliefs	Discrete-wire IDC Connectors, Double-row Sockets	
		Connectors *1	Semi-covers *2
XW2B-40G5-T	XG4M-2030-T	XG5M-2032-N XG5M-2035-N	XG5S-1001

*1. Either the XG5M-□□32-N or the XG5M-□□35-N may be used.

*2. Each Connector requires two Semi-covers.

Daisy Chain Units with a Terminal Block with M3.5 Screws

XW2B-20G5-D

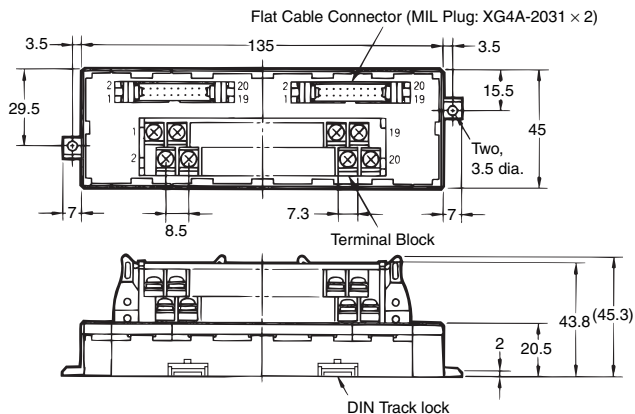
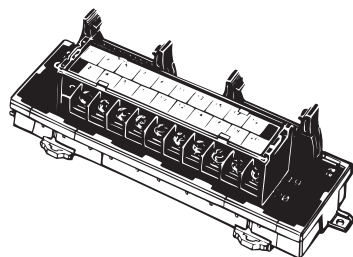

Wiring Diagram

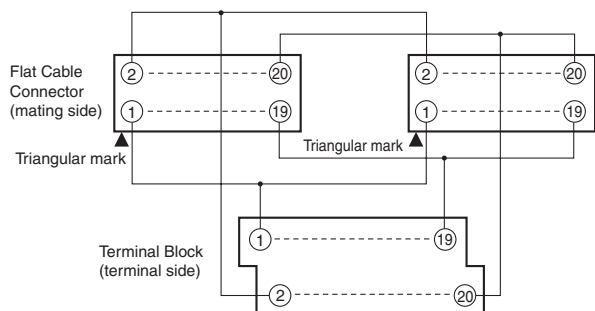

Note: All pins on the Flat Cable Connector correspond 1-to-1 to the terminal of the same number on the terminal block as shown above.

Applicable Connectors

Model	Applicable Connectors (order separately)		
	Flat Cable Connectors, MIL Sockets with Strain Reliefs	Discrete-wire IDC Connectors, Double-row Sockets	
		Connectors *1	Semi-covers *2
XW2B-20G5-D	XG4M-2030-T	XG5M-2032-N XG5M-2035-N	XG5S-1001

*1. Either the XG5M-□□32-N or the XG5M-□□35-N may be used.

*2. Each Connector requires two Semi-covers.

Multi-pole, Square-connector Plug Units with a Terminal Block with M3 Screws

XW2B-□□Y4

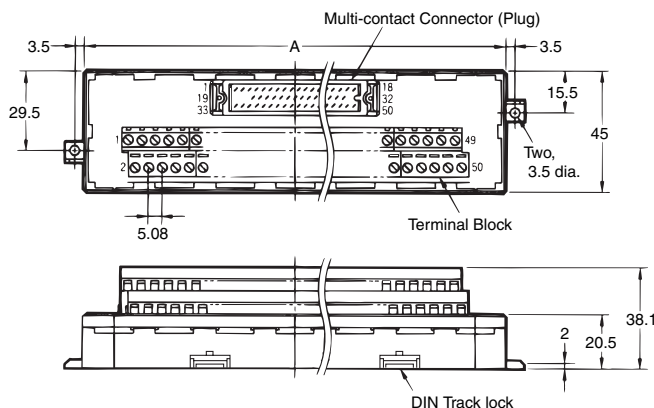
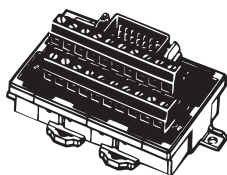

Wiring Diagram (Example for Terminal Block with 50 Poles)

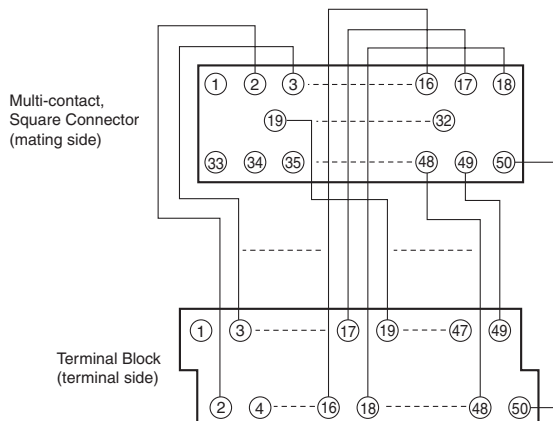

Note: All pins on the Multi-pole, Square Connector correspond 1-to-1 to the terminal of the same number on the terminal block as shown above.

Dimensions

Model	No. of poles	Dimension A (mm)	Applicable Connector models *
XW2B-20Y4	20	67.5	MR-20RMD2
XW2B-34Y4	34	112.5	MR-34RMD2
XW2B-50Y4	50	157.5	MR-50RMD2

*These Connectors are made by Honda Tsushin Kogyo.
 Note: Terminal block pitch is 5.08 mm.
 Use a wire size between 0.3 and 1.25 mm² (AWG22 to AWG16).
 The wire insertion holes are 1.8 × 2.5 (H × W) mm.

Applicable Connectors

Model	Applicable Connectors *1	Hood *1
XW2B-20Y4	MR-20F (soldered) MRP-20F01 (crimped) *2 MR-20FW (wrapped)	MR-20L
XW2B-34Y4	MR-34F (soldered) MRP-34F01 (crimped) *2 MR-34FW (wrapped)	MR-34L
XW2B-50Y4	MR-50F (soldered) MRP-50F01 (crimped) *2 MR-50FW (wrapped)	MR-50L

*1. All applicable Connector Hoods are made by Honda Tsushin Kogyo.
 *2. Use MRP-F113 or MRP-F103 crimp terminals made by Honda Tsushin Kogyo.

Multi-pole, Square-connector Plug Units with a Terminal Block with M3.5 Screws

XW2B-□□Y5

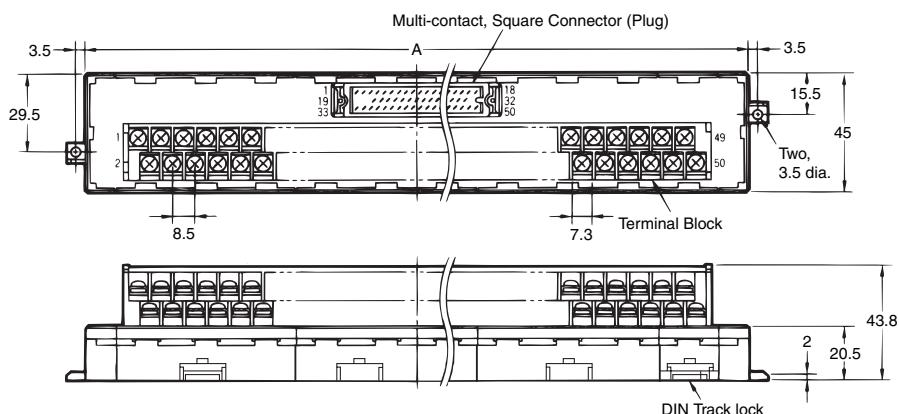
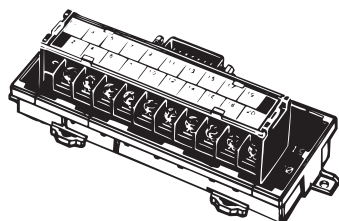

Wiring Diagram (Example for Terminal Block with 50 Poles)

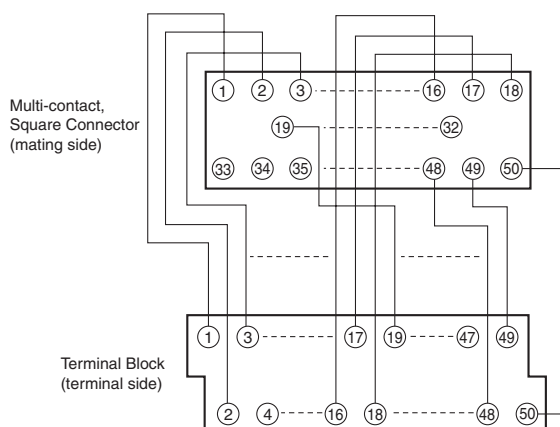

Note: All pins on the Multi-pole, Square Connector correspond 1-to-1 to the terminal of the same number on the terminal block as shown above.

Dimensions

Model	No. of poles	Dimension A (mm)	Applicable Connector models *
XW2B-20Y5	20	112.5	MR-20RMD2
XW2B-34Y5	34	180.0	MR-34RMD2
XW2B-50Y5	50	247.5	MR-50RMD2

*These Connectors are made by Honda Tsushin Kogyo.
Note: Terminal block pitch is 8.5 mm.

Applicable Connectors

Model	Applicable Connectors *1	Hood *1
XW2B-20Y5	MR-20F (soldered) MRP-20F01 (crimped) *2 MR-20FW (wrapped)	MR-20L
XW2B-34Y5	MR-34F (soldered) MRP-34F01 (crimped) *2 MR-34FW (wrapped)	MR-34L
XW2B-50Y5	MR-50F (soldered) MRP-50F01 (crimped) *2 MR-50FW (wrapped)	MR-50L

*1. All applicable Connector Hoods are made by Honda Tsushin Kogyo.

*2. Use MRP-F113 or MRP-F103 crimp terminals made by Honda Tsushin Kogyo.

Multi-pole, Square Connector Socket Units with a Terminal Block with M3.5 Screws

XW2B-□□X5

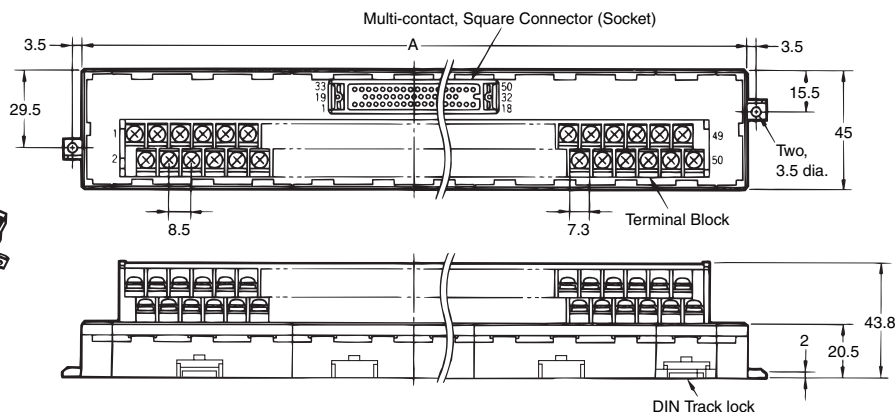
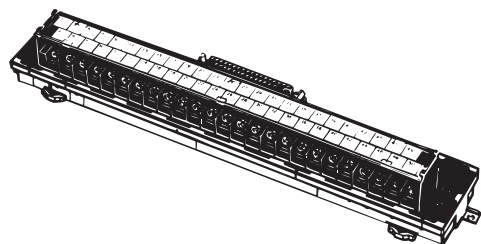

Wiring Diagram (Example for Terminal Block with 50 Poles)

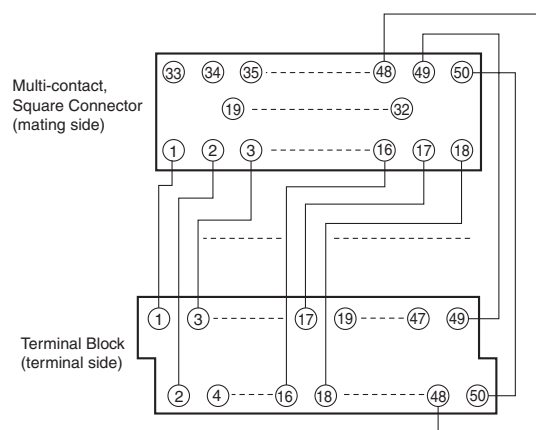

Note: All pins on the Multi-pole, Square Connector correspond 1-to-1 to the terminal of the same number on the terminal block as shown above.

Dimensions

Model	No. of poles	Dimension A (mm)	Applicable Connector models *
XW2B-20X5	20	112.5	MR-20RFD2
XW2B-34X5	34	180.0	MR-34RFD2
XW2B-50X5	50	247.5	MR-50RFD2

*These Connectors are made by Honda Tsushin Kogyo.
Note: Terminal block pitch is 8.5 mm.

Applicable Connectors

Model	Applicable Connectors *1	Hood *1
XW2B-20X5	MR-20M (soldered) MRP-20M01 (crimped) *2 MR-20MW (wrapped)	MR-20L
XW2B-34X5	MR-34M (soldered) MRP-34M01 (crimped) *2 MR-34MW (wrapped)	MR-34L
XW2B-50X5	MR-50M (soldered) MRP-50M01 (crimped) *2 MR-50MW (wrapped)	MR-50L

*1. All applicable Connector Hoods are made by Honda Tsushin Kogyo.

*2. Use MRP-F113 or MRP-F103 crimp terminals made by Honda Tsushin Kogyo.

Board I/O Units with a Terminal Block with M3.5 Screws

XW2B-40F5-P

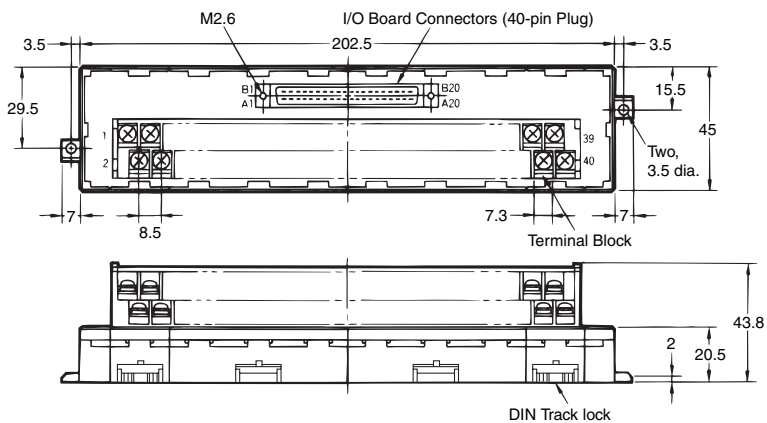
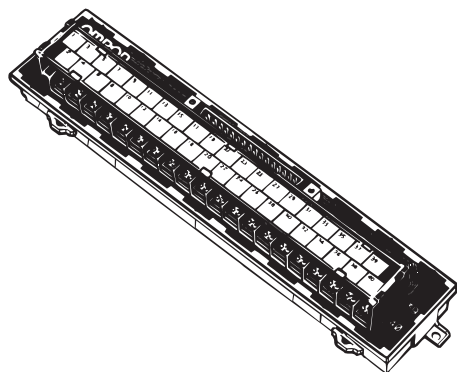

Wiring Diagram

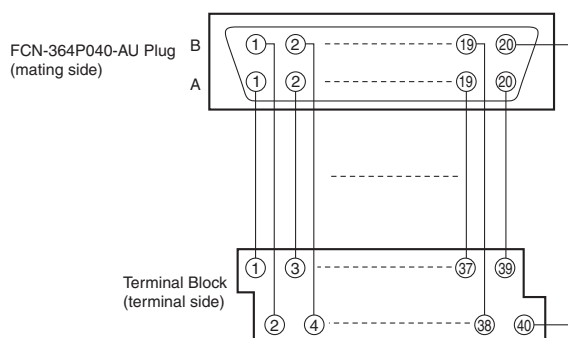

Dimensions

Model	No. of poles	Applicable Connectors and Circuits *
XW2B-40F5-P	40	FCN-364P40-AU (Connector) FCN-360A1 (Anchor)

*These Connectors and circuits are made by Fujitsu.
Note: Terminal block pitch is 8.5 mm.

Applicable Connectors

Model	Applicable Connectors *1	Hood *1
XW2B-40F5-P	FCN361J040-AU (soldered) FCN363J040-AAU (crimped)	FCN360C040-B

*1. All applicable Connectors and Covers are made by Fujitsu.

*2. Refer to the *OMNUC U Series user's manual* for details on the Connecting Cable used between the XW2B-40F5-P and the U-series AC Servo Driver.

Safety Precautions

Precautions for Correct Use

● Wiring

- Always turn OFF the power supply before wiring. Otherwise, cables or other conductors can short the terminals and cause the Unit to fail.
- Do not connect or disconnect Connectors with the power turned ON. Otherwise, it may cause malfunctions.

● Wiring Terminal Blocks

- Direct Wire Connections with a Terminal Block with M3 Screws
 - Use a wire size between 0.3 and 1.25 mm² (AWG22 to AWG16).
 - Prepare the end of each wire as shown in the following diagram.



- The wire insertion holes are 1.8 × 2.5 (H × W) mm on the terminal block with M3 screws.

- Direct Wire Connections with a Terminal Block with M3.5 Screws

Round

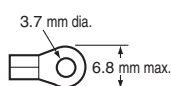

Forked

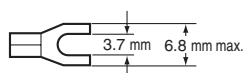

	Applicable crimp terminals	Applicable wires
Round	1.25-3.5	AWG22 to AWG16 (0.30 to 1.25 mm ²)
	2-3.5	AWG16 to AWG14 (1.25 to 2.0 mm ²)
Forked	1.25Y-3.5	AWG22 to AWG16 (0.30 to 1.25 mm ²)
	2Y-3.5	AWG16 to AWG14 (1.25 to 2.0 mm ²)

(With a Terminal Block with M3 Screws)

Round rod

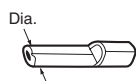

Blade

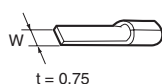

	Applicable crimp terminals	Applicable wires
Rod	TC-05 Dia. = 1	AWG22 to AWG18 (0.30 to 0.75 mm ²)
	TC-1.25S Dia. = 1.5	AWG22 to AWG16 (0.30 to 1.25 mm ²)
Blade	BT1.25-9-1 BT1.25-10-1 W = 2.2	AWG22 to AWG16 (0.30 to 1.25 mm ²)

Note: Round rod and blade crimp terminals are made by Nichifu.

● Terminal Screw Tightening Torque

- Select a tightening torque from the following table when connecting wires or crimp terminals to the terminal block.

Terminal Block	Tightening torque N·m
With M3 screws	0.40
With M3.5 screws	0.59

● Mounting Units to and Removing Units from DIN Track

- For terminal blocks with M3 screws, use a flat-head screwdriver like the one shown in the following diagram.

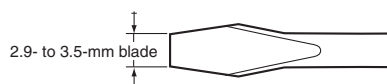

- XW2B Connector-Terminal Block Conversion Units can be mounted side-to-side on DIN Track. The flanges for mounting screws are located on each side at the bottom of the XW2B.
- Secure both ends of the XW2B with End Plates.
- When removing the Unit from a DIN Track, insert a flat-head screwdriver into the slider and pull the lock out.

