

# Fiber Optic Cabling Infrastructure Offering

# **Panduit® Opti-Core®** **Fiber Optic Cable**

## ***High-Speed Fiber Cabling Systems***

Panduit provides high bandwidth and mission-critical physical infrastructures in data center, enterprise, and campus networks with comprehensive fiber optic systems that deliver high performance, reliability, and scalability. The deployment of high-speed cabling systems has been increasing rapidly as data centers enable their physical infrastructure with 10 Gb/s capacity to support server virtualization, I/O consolidation, and convergence of backbone applications.

## ***Structured Cabling Infrastructure***

A properly designed and implemented cabling infrastructure is a fundamental asset of every business. Carefully planning a structured cabling solution facilitates the delivery of new services, lowers network maintenance costs, and increases productivity. New high-bandwidth applications enable organizations to better fulfill their need for productivity and innovation in a rapidly changing world.

## ***Innovative Data Center Infrastructure Solutions***

Panduit provides a comprehensive, intelligent data center offering that supports best practice methodologies. Our data center solutions enable physical to logical architecture integration, and deliver robust, scalable physical infrastructures that address:

- Visibility and control for managing and automating real-time data processes and documentation
- Convergence of new technologies and high-speed data applications
- Operational efficiency through process improvement and IT initiatives, such as cooling conservation through energy efficient data cabinets
- Capacity management for greater real estate utilization
- Modular pods designed to support high-density applications and provide consistent, reliable deployments while lowering infrastructure risk and costs

Panduit's intelligent data center solutions facilitate faster implementation and simple specification, streamlining the process of designing, specifying, installing, and managing the increasingly complex physical infrastructure necessary to optimize your data center. Panduit knows the data center space intimately. We help you discover tangible infrastructure and business process improvements that increase functionality, interoperability, and manageability of mission-critical operations across your entire organization.

## ***High Speed Data Transport Solutions***

High Speed Data Transport (HSDT) Solutions are a set of complementary copper and optical fiber technologies for mission critical data center applications, spanning storage and compute requirements and leading edge architectures. Based on an understanding of today's vital business and technology challenges and how they impact data centers, Panduit has created best-in-class physical infrastructure solutions for HSDT. Panduit provides the broadest offering of end-to-end HSDT solutions supporting all data center architectures. Designed for high-density/high-speed applications, Panduit HSDT solutions are backed by comprehensive research and development programs to ensure high network performance, systems reliability, energy efficiencies, and seamless integration.

## ***PanNet® System Warranty***

All Panduit channels are field tested by Panduit Certified Installers (PCI) using industry standard hand-held devices which provide verified network performance, and ensures your network operates at optimal performance.



## ***Cable Fire Ratings Reference Guide***

Cable fire ratings need to be considered when specifying cabling infrastructure to ensure local building codes are met. The below rating guide provides the information needed to determine which rating is appropriate for different installation environments.

### **Plenum Rated Cable (OFNP)**

A Plenum Rating (OFNP) signifies cable that has passed stringent burn testing and is suitable for installation into air plenum spaces. OFNP cables have fire-resistance and low smoke production characteristics. They can be installed in ducts, plenums, and other spaces used for building airflow. This is the highest fire rating fiber cable and no other cable types can be used as substitutes.

### **Plenum Rated Cable (OFCP)**

A Plenum Rating (OFCP) differs from OFNP in that the cable contains metallic elements, typically armor, and therefore, conducts electricity. All other aspects of this rating are the same as OFNP.

### **Riser Rated Cable (OFNR)**

A Riser Rating (OFNR) is commonly required when cables are run between floors through open vertical shafts. OFNR cables are used in Riser areas which are building vertical shafts or runs from one floor to another floor. OFNR cables cannot be installed in plenum areas since they do not have the required smoke rating as plenum rated cables. OFNP plenum cables can be used as substitutes for OFNR Riser cables.

### **Riser Rated Cable (OFCR)**

A Riser Rating (OFCR) differs from OFNR in that the cable contains metallic elements, such as a layer of armor, and therefore, conducts electricity. All other aspects of this rating are the same as OFNR.

### **Low Smoke Zero Halogen (LSZH)**

A Low Smoke Zero Halogen Rating (LSZH) is sometimes referred to as low toxicity cable. When burned, PVC-based cables produce a cloud of toxic smoke containing corrosive compounds such as hydrochloric acid. The LSZH cables do not contain the Halogen type compounds that form these toxic substances. Smoke emitted from burning LSZH cables do not produce the toxic halogen-based gasses previously mentioned. LSZH ratings are expressed as OFN-LS or OFNR-LS if the cable also meets the requirements of a OFNR rated cable.

### **Non-Flame Rated**

Outside Plant (OSP) cables are intended for outdoor use only. Typically, these cables are constructed using varying densities of Polyethylene, (PE) in the outer jacket, and perhaps in other OSP cable components. Because cables without flame ratings do not contain flame suppressants and emit noxious gasses when burned, building codes often restrict the distance installers are permitted to route inside buildings before termination.

# Fiber Cable for Americas

(North America and Latin America)

## Opti-Core® Interconnect Cable

Used in interconnect, horizontal installations, routing in tight spaces such as panels, cable trays, and fiber-to-the-desk (FTTD) applications.

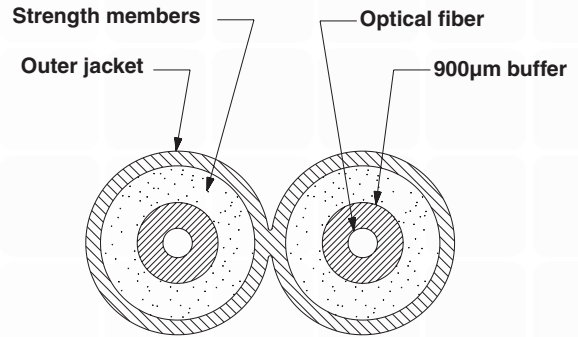
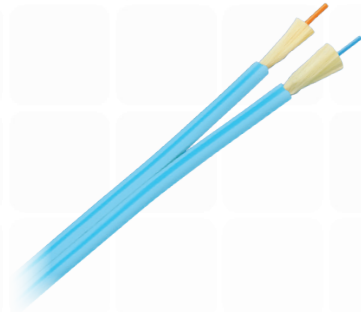

Character	1	2	3	4	5	6	7	8
Example	F	S	I	P	5	0	2	Y

**1 and 2 – Fiber Product**  
 FS = Fiber – OM1, OM2, OS2  
 FO = Fiber – OM3, OM4

**4 – Flame Rating**  
 P = Plenum  
 R = Riser

**3 – Cable Construction**  
 I = Interconnect cable

**5 – Fiber Type**  
 9 = OS2 9/125µm  
 6 = OM1 6.25//125µm  
 5 = OM2 50/125µm  
 X = OM3 10G 50/125µm  
 Z = OM4 10G 50/125µm

**6 and 7 – Fiber Count**  
 02 = 2-fiber  
**8 – RoHS**  
 Y = RoHS compliant

## Opti-Core® Indoor Distribution Cable

For indoor use in intra-building backbone and horizontal installations.

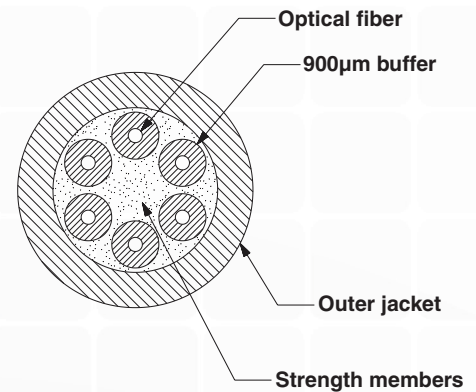
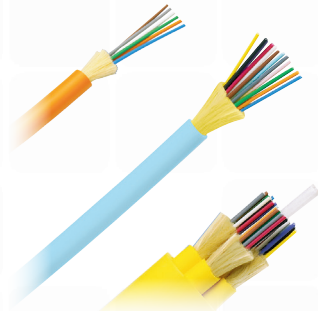

Character	1	2	3	4	5	6	7	8
Example	F	S	D	P	5	0	6	Y

**1 and 2 – Fiber Product**  
 FS = Fiber – OM1, OM2, OS2  
 FO = Fiber – OM3, OM4

**4 – Flame/Smoke Rating**  
 R = Riser (OFNR)  
 P = Plenum (OFNP)

**3 – Cable Construction**  
 D = Distribution cable

**5 – Fiber Type**  
 9 = OS2 9/125µm  
 6 = OM1 62.5/125µm  
 5 = OM2 50/125µm  
 X = OM3 10G 50/125µm  
 Z = OM4 10G 50/125µm

**6 and 7 – Fiber Count**  
 06 = 6-fiber  
 12 = 12-fiber  
 24 = 24-fiber  
 36 = 36-fiber  
 48 = 48-fiber  
 72 = 72-fiber

**8 – RoHS**  
 Y = RoHS compliant

## Opti-Core® Indoor/Outdoor All-Dielectric Cable with Tight Buffered Fibers

These cables provide an effective solution for inter-building and building transition applications.

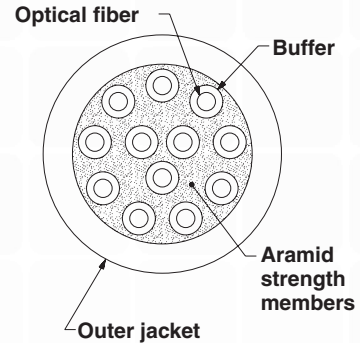
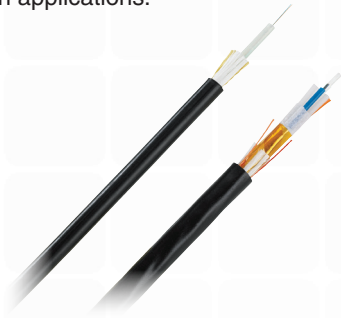

<b>Character</b>	<b>1</b>	<b>2</b>	<b>3</b>	<b>4</b>	<b>5</b>	<b>6</b>	<b>7</b>
<b>Example</b>	<b>F</b>	<b>S</b>	<b>K</b>	<b>R</b>	<b>5</b>	<b>1</b>	<b>2</b>

### 1 and 2 – Fiber Product

FS = Fiber – OM1, OM2, OS2

FO = Fiber – OM3, OM4

### 3 – Cable Construction

K = Indoor/outdoor tight buffered unarmored

### 4 – Flame/Smoke Rating

R = Riser

P = Plenum

### 5 – Fiber Type

9 = OS2 9/125µm

6 = OM1 6.25//125µm

5 = OM2 50/125µm

X = OM3 10G 50/125µm

Z = OM4 10G 50/125µm

### 6 and 7 – Fiber Count

02 = 2-fiber

04 = 4-fiber

06 = 6-fiber

08 = 8-fiber

12 = 12-fiber

24 = 24-fiber

36 = 36-fiber

48 = 48-fiber

72 = 72-fiber

96 = 96-fiber

1A = 144-fiber (Riser only)

## Opti-Core® Indoor/Outdoor All-Dielectric Cable

Allows installation using loose tube cable methods within buildings and outdoor environments for transitional aerial, duct applications, and entrance facilities.

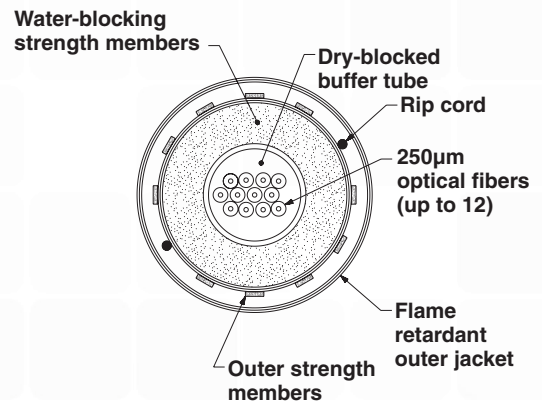
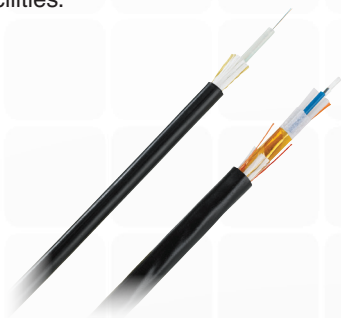

<b>Character</b>	<b>1</b>	<b>2</b>	<b>3</b>	<b>4</b>	<b>5</b>	<b>6</b>	<b>7</b>	<b>8</b>
<b>Example</b>	<b>F</b>	<b>S</b>	<b>C</b>	<b>P</b>	<b>5</b>	<b>0</b>	<b>6</b>	<b>Y</b>

### 1 and 2 – Fiber Product

FS = Fiber – OM1, OM2, OS2

FO = Fiber – OM3, OM4

### 3 – Cable Construction

C = Indoor/outdoor central tube (up to 12 fibers)

N = Indoor/outdoor stranded tube (24 fibers and greater)

### 4 – Flame Rating

R = Riser

P = Plenum

### 5 – Fiber Type

9 = OS2 9/125µm

6 = OM1 62.5/125µm

5 = OM2 50/125µm

X = OM3 10G 50/125µm

Z = OM4 10G 50/125µm

### 6 and 7 – Fiber Count

06 = 6-fiber

12 = 12-fiber

24 = 24 fiber

36 = 36 fiber

48 = 48 fiber

72 = 72 fiber

96 = 96 fiber

1A = 144 fiber

### 8 – RoHS

Y = RoHS compliant

## Opti-Core® Interlocking Armored Cable Offering

### Opti-Core® Indoor Interlocking Armored Cable

Used in intrabuilding backbone, building backbone, and horizontal installations and harsh environments.

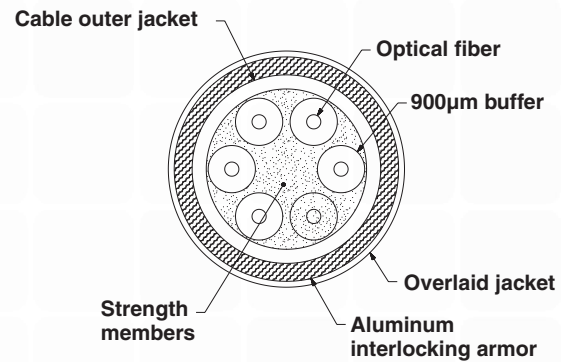

### Opti-Core® Indoor/Outdoor Interlocking Armored Cable with Tight Buffered Fibers

For use indoors and outdoors. Interlocking aluminum armor eliminates the need for inner duct or conduit.

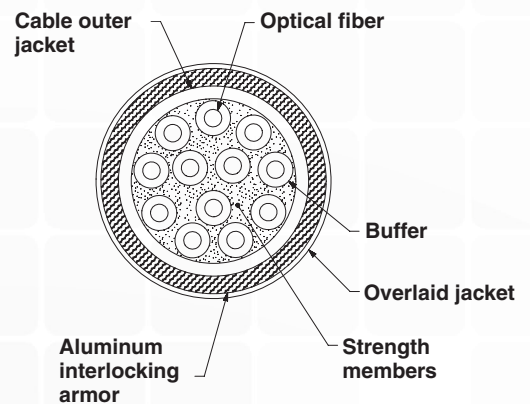
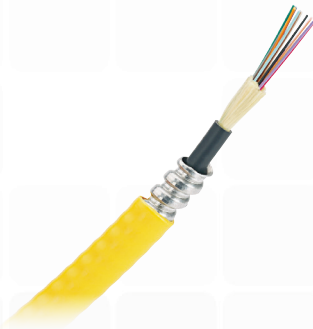

## Opti-Core® Indoor/Outdoor Interlocking Armored Cable

For use indoor and outdoors. Central loose tube constructions. Interlocking aluminum armor eliminates the need for inner duct or conduit.

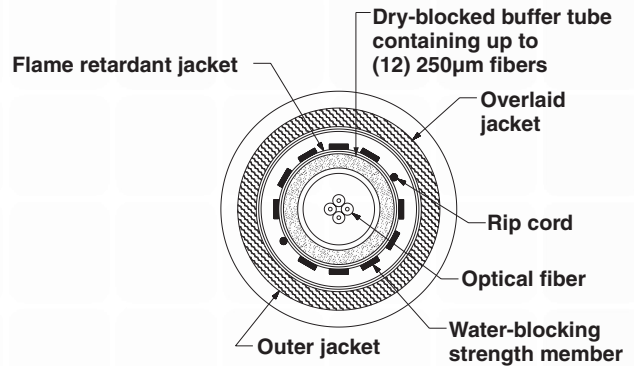
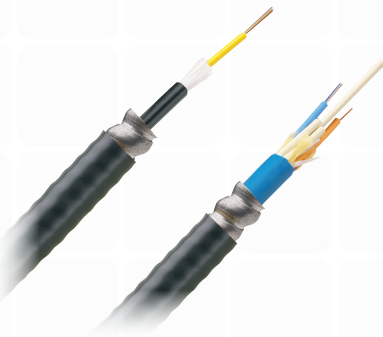

<b>Character</b>	<b>1</b>	<b>2</b>	<b>3</b>	<b>4</b>	<b>5</b>	<b>6</b>	<b>7</b>	<b>8</b>
<b>Example</b>	<b>F</b>	<b>S</b>	<b>G</b>	<b>P</b>	<b>5</b>	<b>0</b>	<b>6</b>	<b>Y</b>

### 1 and 2 – Fiber Product

FS = Fiber – OM1, OM2, OS2  
FO = Fiber – OM3, OM4

### 3 – Cable Construction

G = Indoor/outdoor interlocking armored central tube (up to 12 fibers)  
M = Indoor/outdoor interlocking armored stranded tube (24 fibers and greater)  
L = Indoor/outdoor tight buffered  
P = Indoor interlocking armored

### 4 – Flame Rating

R = Riser  
P = Plenum

### 5 – Fiber Type

9 = OS2 9/125µm  
6 = OM1 62.5/125µm  
5 = OM2 50/125µm  
X = OM3 10G 50/125µm  
Z = OM4 10G 50/125µm

### 6 and 7 – Fiber Count

02 = 2-fiber  
04 = 4-fiber  
06 = 6-fiber  
08 = 8-fiber  
12 = 12-fiber  
24 = 24-fiber  
36 = 36-fiber  
48 = 48-fiber  
72 = 72 fiber  
96 = 96-fiber  
1A = 144-fiber

### 8 – RoHS

Y = RoHS compliant

# Fiber Cable for Americas

(North America and Latin America)

## Opti-Core® Dielectric Conduited Fiber (DCF) Optic Cable

For indoor use in intra-building backbone and horizontal installations.

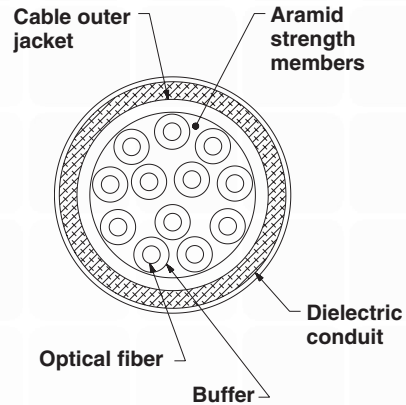

<b>Character</b>	1	2	3	4	5	6	7	8	9	10
<b>Example</b>	F	S	A	D	5	1	2	-	B	L
<b>1 and 2 – Fiber Product</b>	FS = OM1, OM2, OS2 FO = OM3, OM4		<b>5 – Fiber Type</b>	9 = OS2 9/125µm 6 = OM1 6.25/125µm 5 = OM2 50/125µm X = OM3 10G 50/125µm Z = OM4 10G 50/125µm			<b>6 and 7 – Fiber Count</b>		<b>8 – Dash</b>	
<b>3 – Cable Construction</b>	A = Dielectric Conduited Distribution (indoor)					02 = 2-fiber 04 = 4-fiber 06 = 6-fiber 08 = 8-fiber 12 = 12-fiber		9 and 10 – Jacket color BL = Black		
<b>4 – Flame/Smoke Rating</b>	D = Dual rated riser (OFNR) and low smoke zero halogen									

## Opti-Core® Gel-Free All-Dielectric Outside Plant Cable

For use outdoors in aerial and duct applications.

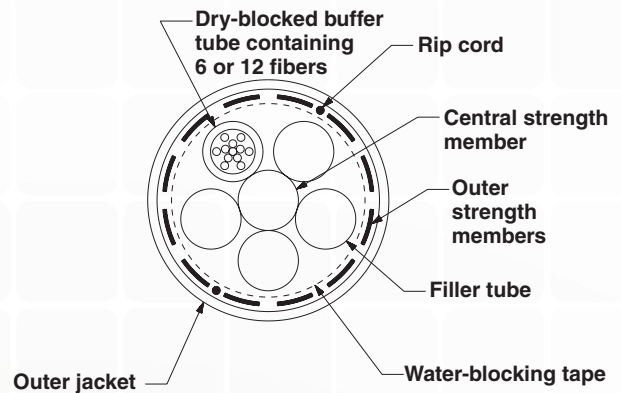
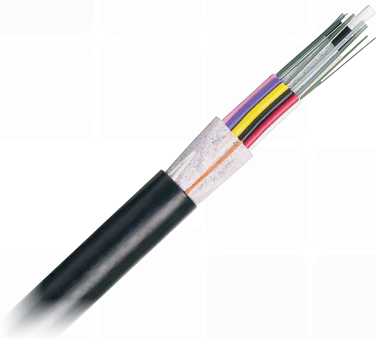

<b>Character</b>	1	2	3	4	5	6	7	
<b>Example</b>	F	O	T	N	X	0	6	
<b>1 and 2 – Fiber Product</b>	FS = Fiber – OM1, OM2, OS2 FO = Fiber – OM3, OM4		<b>3 – Cable Construction</b>	T = Outside plant stranded cable (all fiber counts)			<b>6 and 7 – Fiber Count</b>	
<b>4 – Flame Rating</b>	N = Non-rated					06 = 6-fiber 12 = 12-fiber 24 = 24-fiber 36 = 36-fiber 48 = 48-fiber 72 = 72-fiber 96 = 96-fiber 1A = 144-fiber		
						5 – Fiber Type		
						9 = OS2 9/125µm 6 = OM1 6.25//125µm 5 = OM2 50/125µm X = OM3 10G 50/125µm Z = OM4 10G 50/125µm		



## Opti-Core® Gel-Free Armored Outside Plant Cable

Corrugated steel armor provides superior crush resistance for extended durability in direct burial applications.

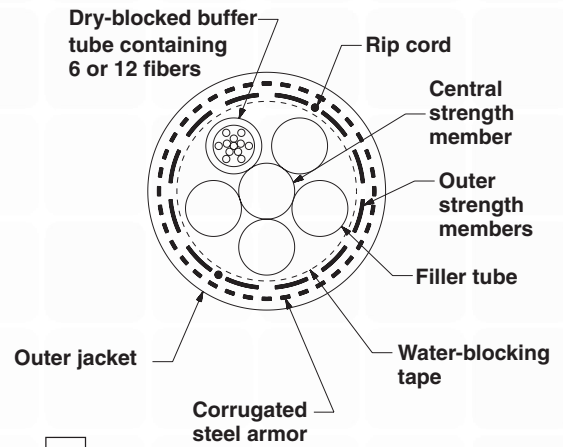
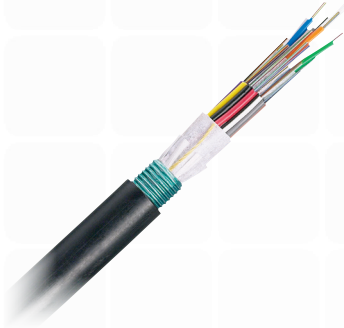

Character

1

2

3

4

5

6

7

Example

F

O

W

N

X

0

6

### 1 and 2 – Fiber Product

FS = Fiber – OM1, OM2, OS2  
FO = Fiber – OM3, OM4

### 3 – Cable Construction

W = Outside plant armored  
stranded cable (all fiber  
counts)

### 4 – Flame/Smoke Rating

N = Non-rated

### 5 – Fiber Type

9 = OS2 9/125µm  
6 = OM1 6.25/125µm  
5 = OM2 50/125µm  
X = OM3 10G 50/125µm  
Z = OM4 10G 50/125µm

### 6 and 7 – Fiber Count

06 = 6-fiber  
12 = 12-fiber  
24 = 24-fiber  
36 = 36-fiber  
48 = 48-fiber  
72 = 72-fiber  
96 = 96-fiber  
1A = 144-fiber

# Fibre Cable for EMEA

(Europe, Middle East, and Africa)

## Opti-Core® Interconnect Cable

Used in interconnect, horizontal installations, and for routing in tight spaces such as panels, cable trays, and fibre-to-the-desk (FTTD) applications.

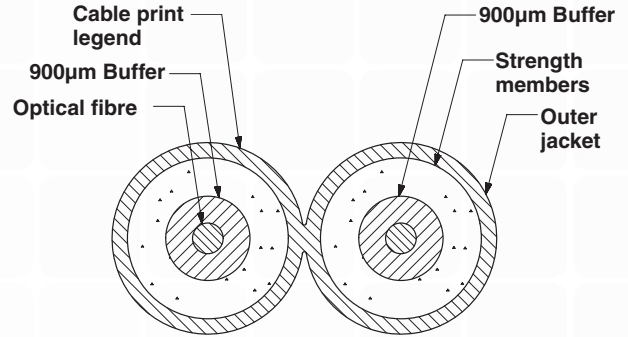
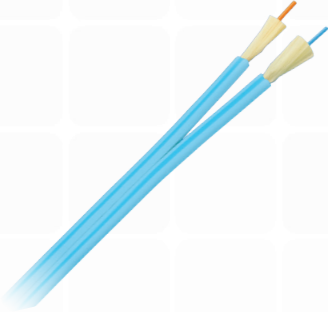

Character	1	2	3	4	5	6	7
Example	F	P	I	L	5	0	2

### 1 and 2 – Fibre Product

FP = Fibre – OM1, OM2, OS2  
FQ = Fibre – OM3, OM4

### 3 – Cable Construction

I = Interconnect zip-cord cable

### 4 – Flame Rating

L = Low smoke zero halogen (LSZH)

### 5 – Fibre Type

9 = OS2 9/125µm  
6 = OM1 62.5/125µm  
5 = OM2 50/125µm  
X = OM3 10G 50/125µm  
Z = OM4 10G 50/125µm

### 6 and 7 – Fibre Count

02 = 2-fibre

## Opti-Core® Indoor Distribution Cable

For indoor use in intrabuilding backbone and horizontal installations.

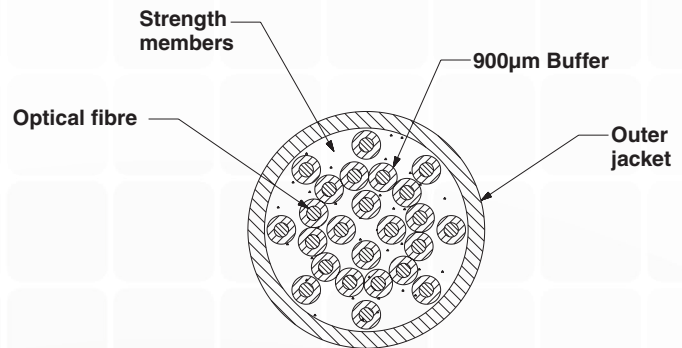
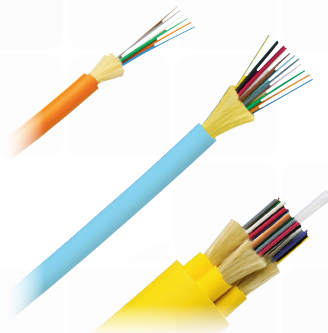

Character	1	2	3	4	5	6	7
Example	F	P	D	L	9	2	4

### 1 and 2 – Fibre Product

FP = Fibre – OM1, OM2, OS2  
FQ = Fibre – OM3, OM4

### 3 – Cable Construction

D = Distribution cable

### 4 – Flame/Smoke Rating

L = Low smoke zero halogen (LSZH)

### 5 – Fibre Type

9 = OS2 9/125µm  
6 = OM1 62.5/125µm  
5 = OM2 50/125µm  
X = OM3 10G 50/125µm  
Z = OM4 10G 50/125µm

### 6 and 7 – Fibre Count

04 = 4-fibre  
08 = 8-fibre  
12 = 12-fibre  
24 = 24-fibre  
36 = 36-fibre  
72 = 72-fibre

**Opti-Core® Indoor/Outdoor All-Dielectric Cable with Tight Buffered Fibres**

For indoor and outdoor use.

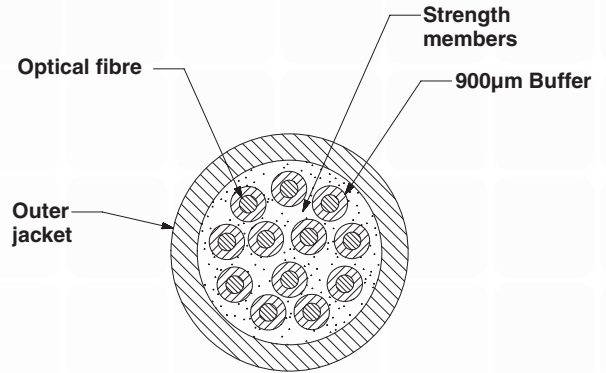
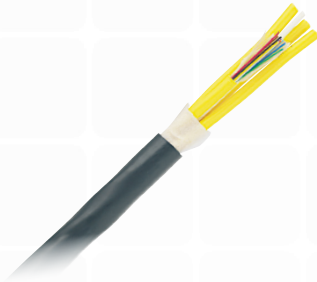

Character	1	2	3	4	5	6	7
Example	F	P	K	L	5	1	2

**1 and 2 – Fibre Product**

FP = Fibre – OM1, OM2, OS2  
FQ = Fibre – OM3, OM4

**3 – Cable Construction**

K = Indoor/outdoor tight buffered unarmored

**4 – Flame Rating**

L – Low smoke zero halogen

**5 – Fibre Type**

9 = OS2 9/125µm  
6 = OM1 62.5/125µm  
5 = OM2 50/125µm  
X = OM3 10G 50/125µm  
Z = OM4 10G 50/125µm

**6 and 7 – Fibre Count**

02 = 2-fibre  
04 = 4-fibre  
06 = 6-fibre  
08 = 8-fibre  
12 = 12-fibre  
24 = 24-fibre

36 = 36-fibre  
48 = 48-fibre  
72 = 72-fibre  
96 = 96-fibre

**Opti-Core® Indoor/Outdoor All-Dielectric Cable**

For use indoor or outdoors. Central and stranded loose tube constructions are all-dielectric.

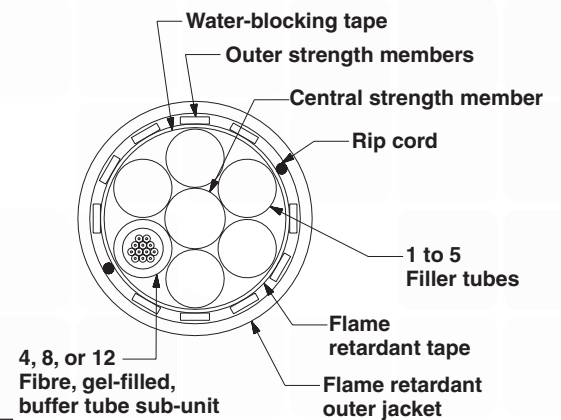
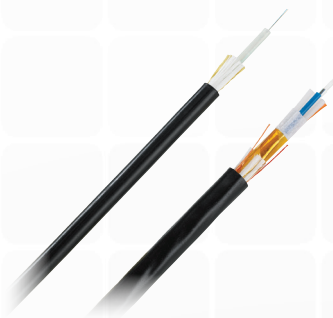

Character	1	2	3	4	5	6	7
Example	F	P	N	L	5	3	6

**1 and 2 – Fibre Product**

FP = Fibre – OM1, OM2, OS2  
FQ = Fibre – OM3, OM4

**3 – Cable Construction**

C = Indoor/outdoor central tube (up to 24 fibres)  
N = Indoor/outdoor stranded tube (36 fibres and greater)

**4 – Flame Rating**

L = Low smoke zero halogen (LSZH)

**5 – Fibre Type**

9 = OS2 9/125µm  
6 = OM1 62.5/125µm  
5 = OM2 50/125µm  
X = OM3 10G 50/125µm  
Z = OM4 10G 50/125µm

**6 and 7 – Fibre Count**

04 = 4-fibre  
08 = 8-fibre  
12 = 12-fibre  
24 = 24-fibre  
36 = 36-fibre  
48 = 48-fibre  
72 = 72-fibre  
96 = 96-fibre

# Fibre Cable for EMEA

(Europe, Middle East, and Africa)

## Opti-Core® Dielectric Conduited (DCF) Fibre Optic Cable

For indoor use in intrabuilding backbone and horizontal installations.

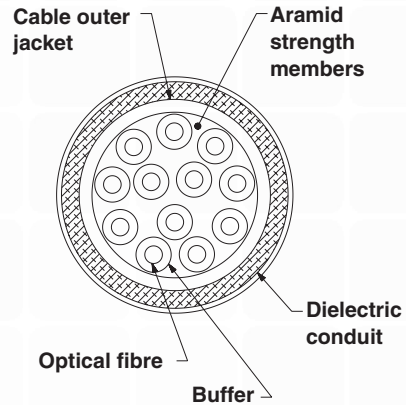

Character	1	2	3	4	5	6	7	8	9	10
Example	F	S	A	D	5	1	2	-	B	L
<b>1 and 2 – Fibre</b>	FS = OM1, OM2, OS2 FO = OM3, OM4		<b>4 – Flame/Smoke Rating</b>	D = Dual rated riser (OFNR) and low smoke zero halogen (LSZH)		<b>6 and 7 – Fibre Count</b>		<b>8 – Dash</b>	<b>9 and 10 – Jacket color</b>	
<b>3 – Cable Construction</b>	A = Dielectric conduited distribution (indoor)		<b>5 – Fibre Type</b>	9 = OS2 9/125µm 6 = OM1 6.25/125µm 5 = OM2 50/125µm X = OM3 10G 50/125µm Z = OM4 10G 50/125µm		02 = 2-fibre 04 = 4-fibre 06 = 6-fibre 08 = 8-fibre 12 = 12-fibre		BL = Black		

## Opti-Core® Gel-Filled All-Dielectric Outside Plant Cable

For use outdoors in aerial or duct applications. Stranded loose tube constructions are all-dielectric. No need to ground or bond.

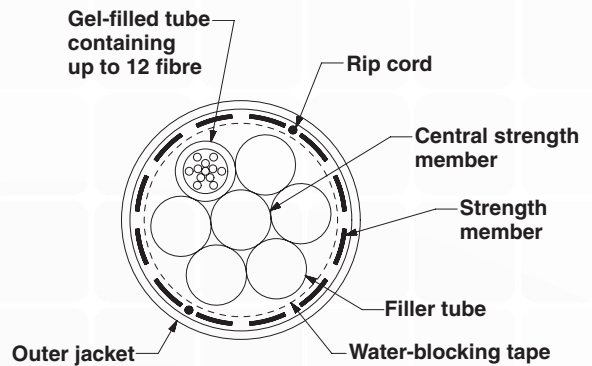

Character	1	2	3	4	5	6	7
Example	F	P	T	N	5	1	2
<b>1 and 2 – Fibre Product</b>	FP = Fibre – OM1, OM2, OS2 FQ = Fibre – OM3, OM4		<b>3 – Cable Construction</b>	U = Indoor/outdoor central tube (up to 24 fibres) T = Indoor/outdoor stranded tube (all fibre counts)		<b>5 – Fibre Type</b>	
<b>4 – Flame Rating</b>	N = Non-rated				9 = OS2 9/125µm 6 = OM1 62.5/125µm 5 = OM2 50/125µm X = OM3 10G 50/125µm Z = OM4 10G 50/125µm		<b>6 and 7 – Fibre Count</b>
						06 = 6-fibre 08 = 8-fibre 12 = 12-fibre 24 = 24-fibre 36 = 36-fibre 48 = 48-fibre 72 = 72-fibre 96 = 96-fibre 1A = 144-fibre	



### Opti-Core® Gel-Filled Single Armor Single Jacket Outside Plant Cable

For use outdoors in direct burial applications. Central loose tube constructions are armored with corrugated steel tape for greater crush resistance.

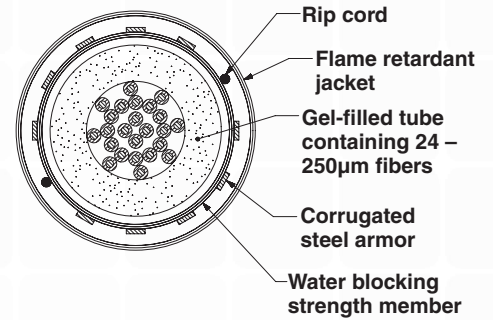
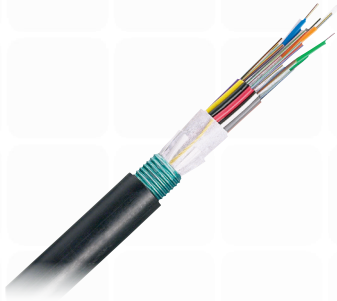

<b>Character</b>	1	2	3	4	5	6	7
<b>Example</b>	F	P	S	N	5	1	2

**1 and 2 – Fibre Product**

FP = Fibre – OM1, OM2, OS2  
FQ = Fibre – OM3, OM4

**3 – Cable Construction**

S = Gel-filled single armor single jacket outside plant cable

**4 – Flame Rating**

N = Non-rated

**5 – Fibre Type**

9 = OS2 9/125µm  
6 = OM1 62.5/125µm  
5 = OM2 50/125µm  
X = OM3 10G 50/125µm  
Z = OM4 10G 50/125µm

**6 and 7 – Fibre Count**

04 = 4-fibre  
06 = 6-fibre  
08 = 8-fibre  
12 = 12-fibre  
24 = 24-fibre

### Opti-Core® Gel-Filled Single Armor Double Jacket Outside Plant Cable

For use outdoors in direct burial applications. Stranded loose tube constructions are armored with corrugated steel tape for greater crush resistance.

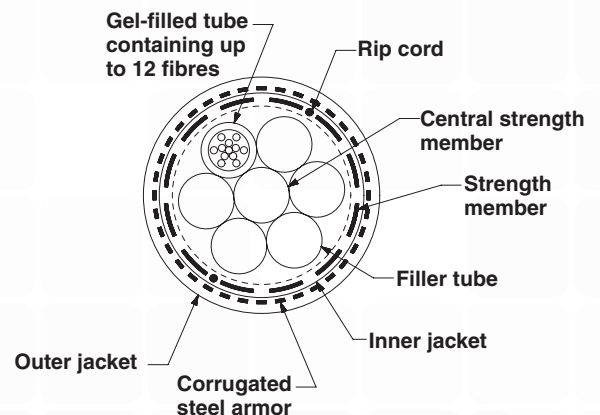
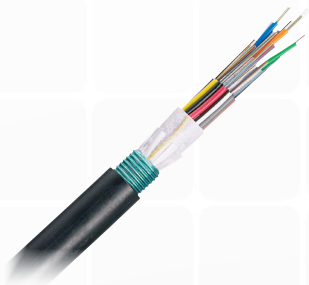

<b>Character</b>	1	2	3	4	5	6	7	8
<b>Example</b>	F	P	Q	N	5	1	2	B

**1 and 2 – Fibre Product**

FP = Fibre – OM1, OM2, OS2  
FQ = Fibre – OM3, OM4

**3 – Cable Construction**

Q = Gel-filled single armor double jacket outside plant cable

**4 – Flame Rating**

N = Non rated

**5 – Fibre Type**

9 = OS2 9/125µm  
6 = OM1 62.5/125µm  
5 = OM2 50/125µm  
X = OM3 10G 50/125µm  
Z = OM4 10G 50/125µm

**6 and 7 – Fibre Count**

02 = 2-fibre  
04 = 4-fibre  
06 = 6-fibre  
08 = 8-fibre  
12 = 12-fibre  
24 = 24-fibre  
36 = 36-fibre

48 = 48-fibre  
72 = 72-fibre  
96 = 96-fibre  
1A = 144-fibre

**8 – Fibre Cable**

B = single armor double jacket stranded tube

# Fiber Cable for APAC

(Asia Pacific)

## Opti-Core® Interconnect Cable

Used in interconnect, horizontal installations, routing in tight spaces such as panels, cable trays, and fiber-to-the-desk (FTTD) applications.

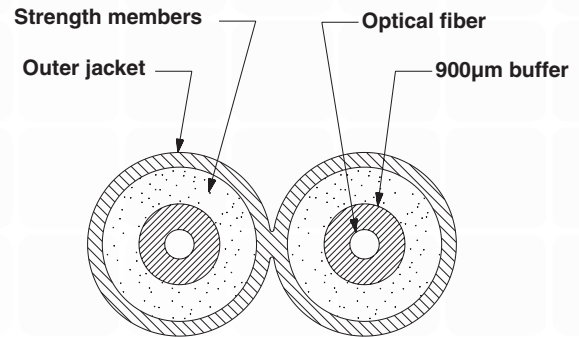
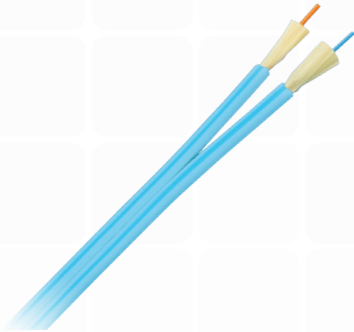

Character

1
F

2
L

3
I

4
L

5
X

6
0

7
2

8
Y

Example

### 1 and 2 – Fiber Product

FL = Fiber – OS2, OM1, OM2, OM3, OM4

### 3 – Cable construction

I = Interconnect zipcord

### 4 – Flame/Smoke Rating

L = Low smoke zero halogen (LSZH)  
R = Riser

### 5 – Fiber Type

9 = OS2 9/125µm  
6 = OM1 6.25/125µm  
5 = OM2 50/125µm  
X = OM3 10G 50/125µm  
Z = OM4 10G 50/125µm

### 6 and 7 – Fiber Count

02 = 2-fiber

### 8 –RoHS

Y = RoHS compliant

## Opti-Core® Indoor Distribution Cable

For indoor use in intrabuilding backbone and horizontal installations.

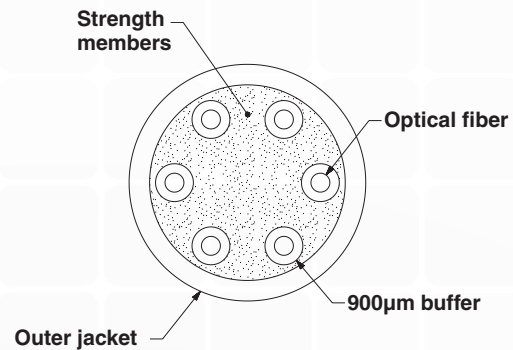
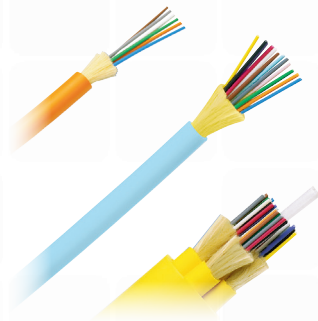

Character

1
F

2
L

3
D

4
L

5
5

6
0

7
6

8
Y

Example

### 1 and 2 – Fiber Product

FL = Fiber – OS2, OM1, OM2, OM3, OM4

### 3 – Cable Construction

D = Distribution cable

### 4 – Flame/Smoke Rating

L = Low smoke zero halogen (LSZH)  
R = Riser

### 5 – Fiber Type

9 = OS2 9/125µm  
6 = OM1 62.5/125µm  
5 = OM2 50/125µm  
X = OM3 10G 50/125µm  
Z = OM4 10G 50/125µm

### 6 and 7 – Fiber Count

02 = 2-fiber  
04 = 4-fiber  
06 = 6-fiber  
08 = 8-fiber  
12 = 12-fiber  
24 = 24-fiber  
36 = 36-fiber  
48 = 48-fiber

### 8 – RoHS

Y = RoHS compliant

## Opti-Core® Indoor/Outdoor All-Dielectric Cable with Tight Buffered Fibers

For use indoor and outdoors.

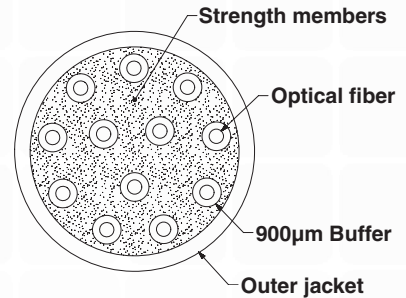

Character	1	2	3	4	5	6	7
Example	F	L	K	R	5	1	2

### 1 and 2 – Fiber Product

FL = Fiber – OM1, OM2, OS2, OM3, OM4

### 3 – Product Type

K = Indoor/outdoor tight buffered unarmored

### 4 – Flame/Smoke Rating

R = Riser (ONFR)  
L = Low Smoke Zero halogen (LSZH)

### 5 – Fiber Type

9 = OS2 9/125µm  
6 = OM1 62.5/125µm  
5 = OM2 50/125µm  
X = OM3 10G 50/125µm  
Z = OM4 10G 50/125µm

### 6 and 7 – Fiber Count

04 = 4-fiber  
06 = 6-fiber  
08 = 8-fiber  
12 = 12-fiber  
16 = 16-fiber  
24 = 24-fiber  
48 = 48-fiber  
72 = 72-fiber

## Opti-Core® Indoor/Outdoor All-Dielectric Cable

For use indoor or outdoors. Central loose tube and stranded loose tube constructions are all-dielectric.

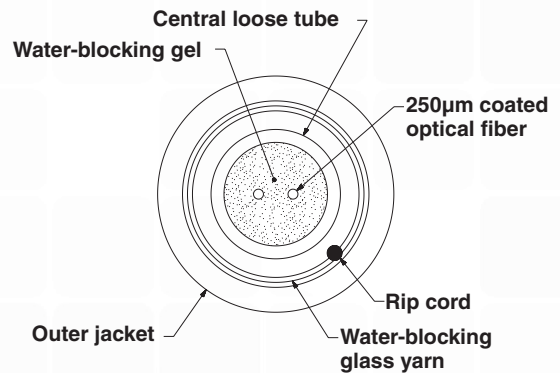
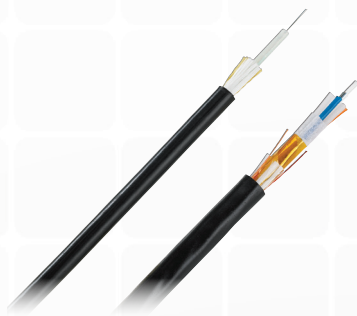

Character	1	2	3	4	5	6	7	8
Example	F	L	C	L	5	0	2	Y

### 1 and 2 – Fiber Product

FL = Fiber – OM1, OM2, OS2, OM3, OM4

### 3 – Product Type

C = Indoor/outdoor central tube (up to 12 fibers)  
N = Indoor/outdoor stranded tube (24 fibers and greater)

### 4 – Flame/Smoke Rating

R = Riser (OFNR)  
L = Low smoke zero halogen (LSZH)

### 5 – Fiber Type

9 = OS2 9/125µm  
6 = OM1 62.5/125µm  
5 = OM2 50/125µm  
X = OM3 10G 50/125µm  
Z = OM4 10G 50/125µm

### 6 and 7 – Fiber Count

02 = 2-fiber  
04 = 4-fiber  
08 = 8-fiber  
12 = 12-fiber  
24 = 24-fiber  
36 = 36-fiber  
48 = 48-fiber

# Fiber Cable for APAC

(Asia Pacific)

## Opti-Core® Dielectric Conduited (DCF) Fiber Optic Cable

For indoor use in intrabuilding backbone and horizontal installations.

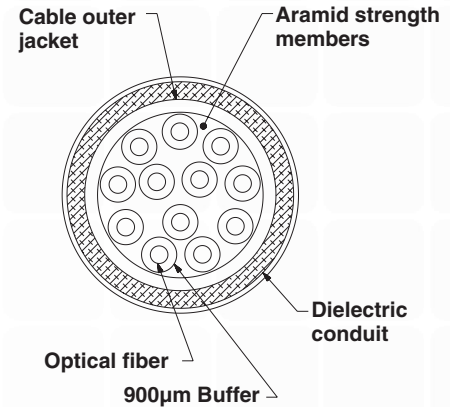

Character	1	2	3	4	5	6	7	8	9	10
Example	F	S	A	D	5	1	2	-	B	L
<b>1 and 2 – Fiber Product</b>	FS= OM1, OM2, OS2 FO= OM3, OM4		<b>4 – Flame/Smoke Rating</b>	D = Dual rated riser (OFNR) and low smoke zero halogen (LSZH)		<b>6 and 7 – Fiber Count</b>		<b>8 – Dash</b> <b>9 and 10 – Jacket color</b> BL = Black		
<b>3 – Cable Construction</b>	A = Dielectric conduited distribution (indoor)		<b>5 – Fiber Type</b>	9 = OS2 9/125µm 6 = OM1 6.25/125µm 5 = OM2 50/125µm X = OM3 10G 50/125µm Z = OM4 10G 50/125µm		02 = 2-fiber 04 = 4-fiber 06 = 6-fiber 08 = 8-fiber 12 = 12-fiber				

## Opti-Core® Gel-Filled All-Dielectric Outside Plant Cable

For use outdoors in aerial or duct applications. Stranded constructions are all-dielectric. Gel-filled. Non-rated PE outer jacket.

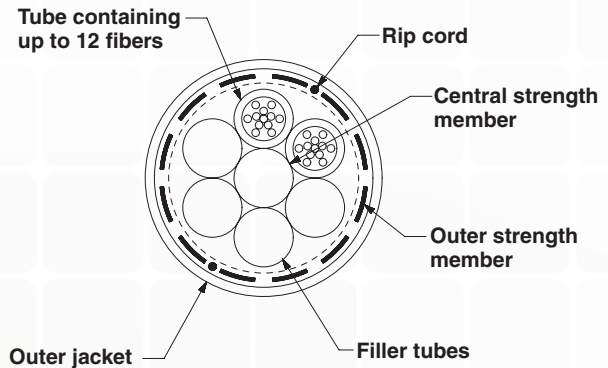
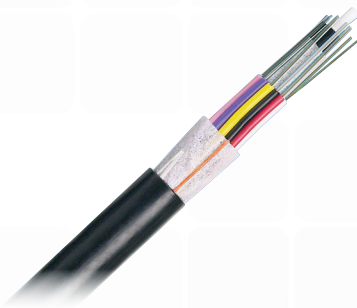

Character	1	2	3	4	5	6	7			
Example	F	L	T	N	5	1	2			
<b>1 and 2 – Fiber</b>	FL = Fiber – OS2, OM1, OM2, OM3, OM4		<b>5 – Fiber Type</b>	9 = OS2 9/125µm 6 = OM1 62.5/125µm 5 = OM2 50/125µm X = OM3 10G 50/125µm Z = OM4 10G 50/125µm		<b>6 and 7 – Fiber Count</b>		48 = 48-fiber 72 = 72-fiber 96 = 96-fiber 1A = 144-fiber		
<b>3 – Cable Construction</b>	T = Outside plant stranded cable (all fiber counts)					02 = 2-fiber 04 = 4-fiber 06 = 6-fiber 08 = 8-fiber 12 = 12-fiber 24 = 24-fiber 36 = 36-fiber				
<b>4 – Flame/Smoke Rating</b>	N = Non-rated									



## Opti-Core® Gel-Filled Armored Outside Plant Cable

For use outdoors in direct burial applications. Stranded loose tube constructions are armored with corrugated steel tape for greater crush resistance. Gel-filled. Non-rated PE outer jacket.

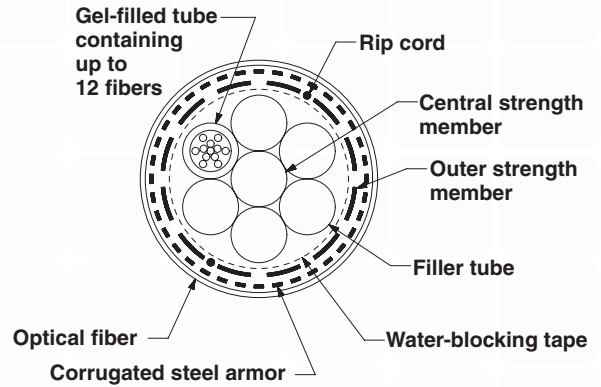
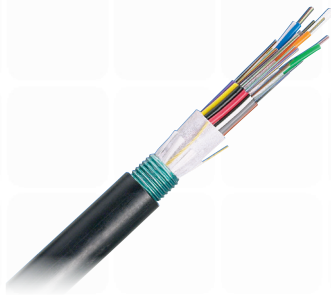

Character	1	2	3	4	5	6	7
Example	F	L	W	N	5	1	2
<b>1 and 2 – Fiber Product</b>	FL = Fiber – OS2, OM1, OM2, OM3, OM4		<b>5 – Fiber Type</b>		<b>6 and 7 – Fiber Count</b>		
<b>3 – Cable Construction</b>	W = Outside plant armored stranded cable (all fiber counts)		9 = OS2 9/125µm		02 = 2-fiber		
<b>4 – Flame/Smoke Rating</b>	N = Non-rated		6 = OM1 62.5/125µm		04 = 4-fiber		
			5 = OM2 50/125µm		06 = 6-fiber		
			X = OM3 10G 50/125µm		08 = 8-fiber		
			Z = OM4 10G 50/125µm		12 = 12-fiber		
					24 = 24-fiber		
					36 = 36-fiber		
					48 = 48-fiber		
					72 = 72-fiber		
					96 = 96-fiber		
					1A = 144-fiber		

# Pre-Polished Fiber Optic Kit & Connectors

## **OptiCam® Pre-Polished Cam Fiber Optic Termination Kit**

- For termination of all Panduit OptiCam® Pre-Polished and Field Polish Connectors
- OptiCam® Termination Tool simplifies tooling and termination, and virtually eliminates operator error by providing visual indication of proper termination after the cam step has been completed
- No adhesive or electricity required for pre-polished termination
- Include installation instructions and stripping templates for all Panduit® OptiCam® Pre-Polished Connectors; also available on [www.panduit.com](http://www.panduit.com)

## **Field Polish Fiber Optic Termination Kit**

- Fast acting adhesive; no long curing epoxy required for field polish termination
- FIELDKIT provides consumable for terminating up to 200 field polish connectors
- Include installation instructions and stripping templates for all Panduit Field Polish Connectors; also available on [www.panduit.com](http://www.panduit.com)



**FIELDKIT for use with Field Polished  
Fiber Optic Connectors**



**FCAMKIT for use with Pre-Polished  
Fiber Optic Connectors**

## **OptiCam® Pre-Polished and Field Polish Fiber Optic Connectors**

- TIA/EIA-604 FOCIS compatible connectors
- Exceed TIA/EIA-568-B.3 requirements
- Connector housing and boot colors follow TIA/EIA-568-C.3 suggested color identification scheme
- Non-optical disconnect maintains data transmission under tensile loads for jacketed cable
- Quick installation; provide field termination in less than half the time of field polish connectors
- Patented re-termination capability provides yield rates approaching 100%
- Factory pre-polished fiber endface eliminates time-consuming field polishing to reduce installation costs, labor, scrap and the number of tools required
- Cam activated fiber and buffer clamp mechanisms provide superior fiber and buffer retention – less sensitivity to fiber tensile loading

## Opti-Cam® Pre-Polished Fiber Optic Connectors

### LC OptiCam® Pre-Polished Fiber Optic Connectors

Quick installation - provides field termination in less than half the time of field polish connectors. Patented re-termination capability.

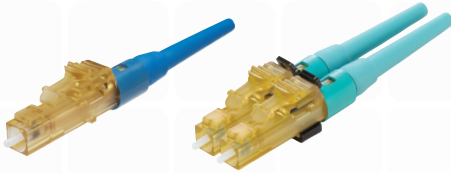

### selection information

Part Number	Connector Type	Ferrule Material	Fiber	Ferrule Finish	Backbone Color	Boot Color	Average Insertion Loss**	Return Loss
FLCSMCXAQY	Simplex	Zirconia Ceramic	10 GbE 50/125µm (laser optimized) OM3/OM4	SPC	Aqua	Aqua	0.3dB	>26dB
FLCDMCXAQY	Duplex							
FLCSMC5BLY	Simplex	Zirconia Ceramic	50/125µm OM2	SPC	Black	Black	0.3dB	>20dB
FLCDMC5BLY	Duplex							
FLCSMC6BLY	Simplex	Zirconia Ceramic	62.5/125µm OM1	SPC	Electric Ivory	Black	0.3dB	>20dB
FLCDMC6BLY	Duplex							
FLCSCBUY	Simplex	Zirconia Ceramic	9/125µm OS1/OS2	UPC	Blue	Blue	0.3dB	>50dB
FLCDSCBUY	Duplex							

\*All connector insertion loss values calculated from tests taken with precision launch jumper assemblies per TIA/EIA-FOTP-171.

### SC OptiCam® Pre-Polished Fiber Optic Connectors

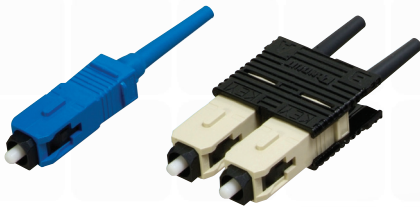

### selection information

Part Number	Connector Type	Ferrule Material	Fiber	Ferrule Finish	Housing Color	Backbone Color	Boot Color	Average Insertion Loss**	Return Loss
FSCMCXAQ	Simplex	Zirconia Ceramic	10 GbE 50/125µm (laser optimized) OM3/OM4	SPC	Black	Aqua	Aqua	0.3dB	>26dB
FSCDMCXAQ	Duplex								
FSCMC5BL	Simplex	Zirconia Ceramic	50/125µm OM2	SPC	Black	Black	Black	0.3dB	>20dB
FSCDMC5BL	Duplex								
FSCMPC5BL	Simplex	Composite	62.5/125µm OM1	SPC	Electric Ivory	Electric Ivory	Black	0.3dB	>20dB
FSCMC6BL	Simplex	Zirconia Ceramic							
FSCDMC6BL	Duplex	Zirconia Ceramic							
FSCMPC6BL	Simplex	Composite	9/125µm OS1/OS2	UPC	Blue	Blue	Blue	0.3dB	>50dB
FSCSCBU	Simplex	Zirconia Ceramic							

\*\*All connector insertion loss values calculated from tests taken with precision launch jumper assemblies per TIA/EIA-FOTP-171.

# Field Polished Fiber Optic Kit & Connectors

## ST OptiCam® Pre-Polished Fiber Optic Connectors

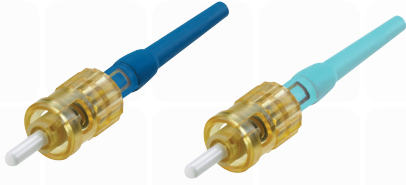

### selection information

Part Number	Connector Type	Ferrule Material	Fiber	Ferrule Finish	Backbone Color	Boot Color	Average Insertion Loss**	Return Loss
FSTMCXAQ	Simplex	Zirconia Ceramic	10 GbE 50/125µm (laser optimized) OM3/OM4	SPC	Aqua	Aqua	0.3dB	>26dB
FSTMC5BL	Simplex	Zirconia Ceramic	50/125µm OM2		Black	Black	0.3dB	>20dB
FSTMC6BL	Simplex	Zirconia Ceramic	62.5/125µm OM1		Black	Black	0.3dB	>20dB
FSTSCBU	Simplex	Zirconia Ceramic	9/125µm OS1/OS2	UPC	Blue	Blue	0.3dB	>50dB

\*\*All connector insertion loss values calculated from tests taken with precision launch jumper assemblies per TIA/EIA-FOTP-171.

## Field Polish Fiber Optic Connectors

### LC OptiCam® Field Polish Fiber Optic Connectors

Non-optical disconnect maintains data transmission under tensile loads for jacketed cable. Tight buffered fiber cable type recommended.

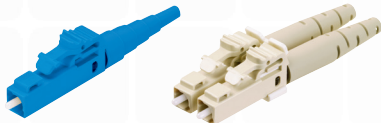

### selection information

Part Number	Connector Type	Cable Type	Fiber	Ferrule	Housing Color	Boot Color	Average Insertion Loss*	Return Loss
FLCSMEIY	Simplex	900µm buffered fiber and 1.6mm – 2.0mm jacketed cable	OM1 Multimode	Zirconia Ceramic	Electric Ivory	Electric Ivory	0.1dB	>20
FLCSM3.0EI	Simplex	3.0mm jacketed cable						
FLCDMEIY	Duplex	1.6mm – 2.0mm jacketed cable						
FLCDM900EIY	Duplex	900µm buffered fiber						
FLCDM3.0EI	Duplex	3.0mm jacketed cable						
FLCSMBLY	Simplex	900µm buffered fiber and 1.6mm – 2.0mm jacketed cable	OM2, OM3, OM4 Multimode	Zirconia Ceramic	Black	Black	0.1dB	>20
FLCSM3.0BL	Simplex	3.0mm jacketed cable						
FLCDBLY	Duplex	1.6mm – 2.0mm jacketed cable						
FLCDM900BLY	Duplex	900µm buffered fiber						
FLCDM3.0BL	Duplex	3.0mm jacketed cable						

\*All connector insertion loss values calculated from tests taken with precision launch jumper assemblies per TIA/EIA-FOTP-171.



## SC OptiCam® Field Polish Fiber Optic Connectors



Part Number	Connector Type	Cable Type	Fiber	Ferrule	Housing Color	Boot Color	Average Insertion Loss*	Return Loss	
FSCM5BL	Simplex	900µm buffered fiber and 3.0mm jacketed cable	Multimode	Zirconia Ceramic	Black	Black	0.1dB	>20	
FSCM2.05BL	Simplex	900 micron buffered fiber and 1.6 – 2.0mm jacketed cable							
FSCDM5BL	Duplex	3.0mm jacketed cable							
FSCMBL	Simplex	900µm buffered fiber and 3.0mm jacketed cable							
FSCMRD	Simplex	900µm buffered fiber and 3.0mm jacketed cable			Electric Ivory	Red			
FSCM2.0BL	Simplex	900µm buffered fiber and 1.6mm – 2.0mm jacketed cable							Black
FSCM2.0RD	Simplex	900µm buffered fiber and 1.6mm – 2.0mm jacketed cable							
FSCDM	Duplex	3.0mm jacketed cable							Red and Black
FSCSBU	Simplex	900µm buffered fiber and 3.0mm jacketed cable	Singlemode	Zirconia Ceramic	Blue	Blue	0.15dB	>40	
FSCS2.0BU	Simplex	900µm buffered fiber and 1.6mm – 2.0mm jacketed cable							

\*All connector insertion loss values calculated from tests taken with precision launch jumper assemblies per TIA/EIA-FOTP-171.

## ST OptiCam® Field Polish Fiber Optic Connectors



### selection information

Part Number	Connector Type	Ferrule Material	Fiber	Ferrule Finish	Housing Color	Backbone Color	Boot Color	Average Insertion Loss*	Return Loss
FSTMABL	Simplex	Zirconia Ceramic	Multimode	UPC	Black	Nickel Plated Zinc	Black	0.15dB (multimode)	>20dB (multimode)
FSTMARD	Simplex	Zirconia Ceramic	Multimode	UPC	Red	Nickel Plated Zinc	Red	0.15dB (multimode)	>20dB (multimode)
FSTSABU	Simplex	Zirconia Ceramic	Singlemode	UPC	Blue	Nickel Plated Zinc	Blue	0.20dB (single-mode)	>40dB (singlemode)

\*All connector insertion loss values calculated from tests taken with precision launch jumper assemblies per TIA/EIA-FOTP-171.

## TIA 598-C

The Telecommunications Industry Association's TIA-598-C Optical Fiber Cable Color Coding, is an American National Standard, that provides all necessary information for color-coding optical fiber cables in a uniform manner. It defines identification schemes for fibers, buffered fibers, fiber units, and groups of fiber units within outside plant and premises optical fiber cables. This standard allows for fiber units to be identified by means of a printed legend. The legend will contain a corresponding printed numerical position number and/or color for use in identification.

### TIA-598-C Fiber Color Code Chart

1	Blue	13	Blue with black tracer
2	Orange	14	Orange with black tracer
3	Green	15	Green with black tracer
4	Brown	16	Brown with black tracer
5	Slate	17	Slate with black tracer
6	White	18	White with black tracer
7	Red	19	Red with black tracer
8	Black	20	Black with black tracer
9	Yellow	21	Yellow with black tracer
10	Violet	22	Violet with black tracer
11	Rose	23	Rose with black tracer
12	Aqua	24	Aqua with black tracer

Contact Customer Service for fiber cable minimum order quantities, lead times, and stocked availability.



**PANDUIT®**

**Panduit Corp.  
World Headquarters  
Tinley Park, IL 60487**

**cs@panduit.com**

**US and Canada: 800.777.3300**

**Europe, Middle East, and Africa:**

**44.20.8601.7200**

**Latin America: 52.33.3777.6000**

**Asia Pacific: 65.6305.7575**

**[www.panduit.com](http://www.panduit.com)**