

THIS COPY IS PROVIDED ON A RESTRICTED BASIS AND IS NOT TO BE USED IN ANY WAY DETRIMENTAL TO THE INTERESTS OF PANDUIT CORP.

Material	High Conductivity Seamless Copper Tube
Plating	Electro-Tin
Wire Size	4 STR/FLEX (ALL), 3 & 5 FLEX*
Wire Type	Stranded Copper: Class B & C, Compact, Class G, H, I, K, M, Locomotive (*Locomotive only)
Wire Strip Length	5/8 in.
Stud Size	1/4 in.
UL Listed Wire Connector	Yes, for applications up to 35kv. Consult cable manufacturer for voltage stress relief instructions with applications greater than 2000 volts.
UL Temperature Rating	90° C
C.S.A Certified Wire Connector	Yes
Panduit Color Code on Barrel	GRAY
Panduit Die Index No. on Barrel	P29
Alternate Industry Die Index No. () on Barrel	(8)

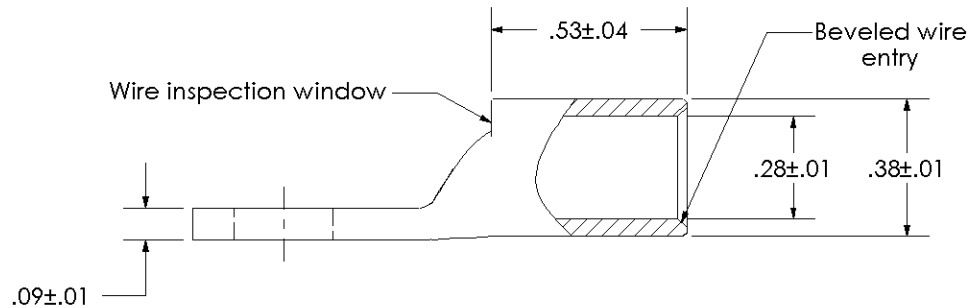
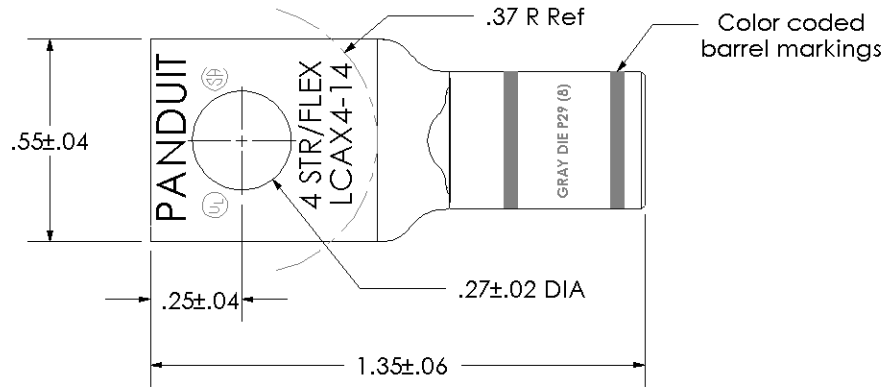

02	3/04	KLFU	TLCO	WIRE SIZE WAS: 4 STR/FLEX ADDED 3 & 5 FLEX, LOCOMOTIVE ONLY *NOTE	11610
REV	DATE	BY	CHK	DESCRIPTION	ECN

PANDUIT CORP. TINLEY PARK, ILLINOIS

LCAX4-14-L
Copper Lug - One-Hole, Standard Flex Barrel

SCALE N/A DRAWING NO / CAD FILE LCAX4-14-CUST