

THIS COPY IS PROVIDED ON A RESTRICTED BASIS AND IS NOT TO BE USED IN ANY WAY DETRIMENTAL TO THE INTERESTS OF PANDUIT CORP.

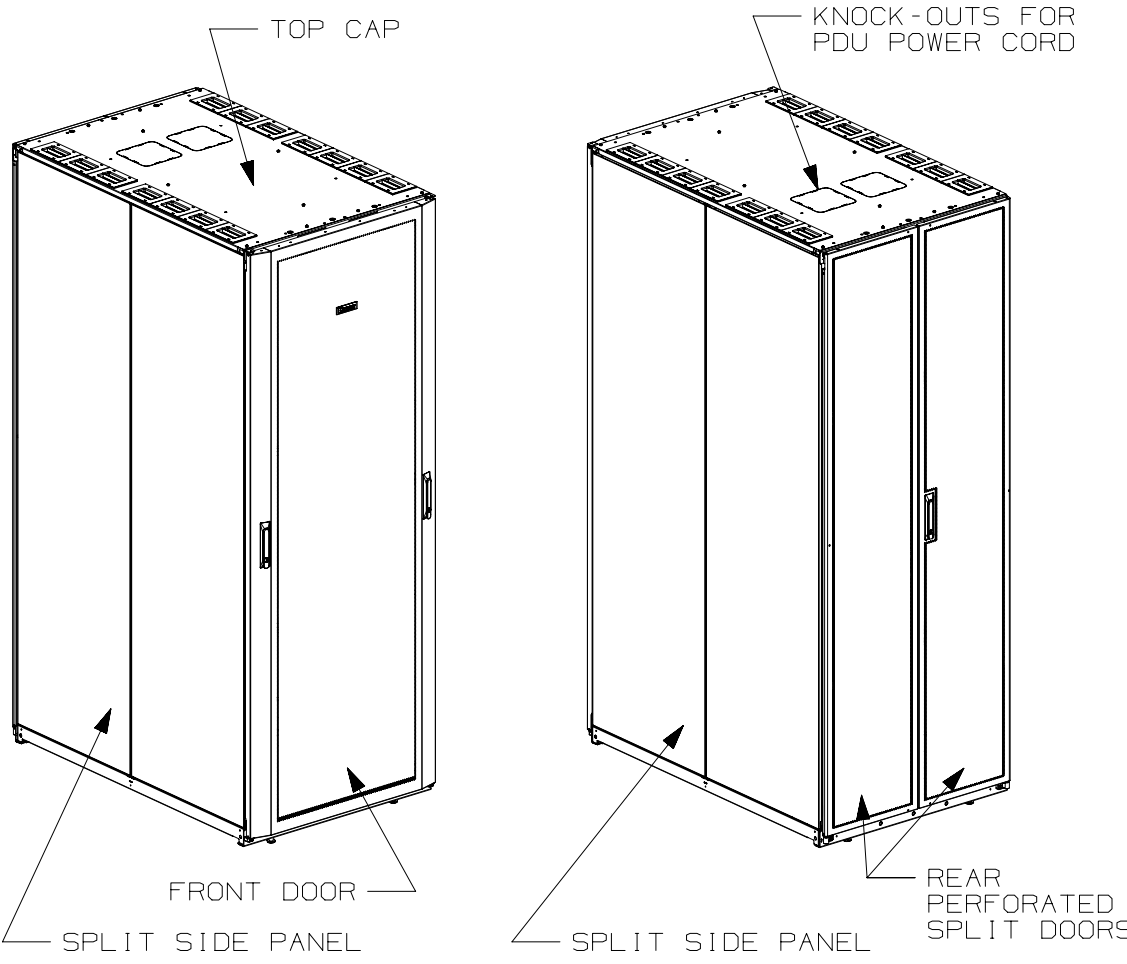
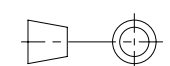

1. VISIT OUR ON-LINE CATALOG AT WWW.PANDUIT.COM FOR A LIST OF CURRENT PARTS APPLICABLE FOR USE WITH THIS PRODUCT.
2. PRIMARY DIMENSIONS ARE IN MILLIMETERS.
3. INDEPENDENT ADJUSTABLE REAR EQUIPMENT MOUNTING RAILS (EIA) ADJUST FROM 130mm [5.1in] TO 422mm [16.6in], AND FROM 469mm [18.46in] TO 751mm [29.56in]. WITH NO FINGERS OR PDU'S, 913mm [35.94in] TO 964mm [37.95in].
4. CAN BE USED WITH ANY 19" EIA STANDARD COMPONENT IN ADDITION TO ALL PANDUIT HORIZONTAL CABLE MANAGEMENT AND PATCH PANEL PRODUCTS.
5. EIA UNIVERSAL STANDARD HOLE PROGRESSION ON EQUIPMENT RAILS 15.88mm [.625in], 15.88mm [.625in], 12.70mm [.5in], 15.88mm [.625in], 15.88mm [.625in], 12.7mm [.5in]...ETC.
6. PARTS SUPPLIED:
 -BASE CABINET
 OPTIONAL COMPONENTS:
 -FRONT DOOR (SEE CHART ON SHEETS 2,3&4)
 -REAR PERFORATED SPLIT DOOR (SEE CHART ON SHEETS 2,3&4)
 -EQUIPMENT RAILS FRONT & REAR (SEE CHART ON SHEETS 2,3&4)
 -SPLIT SIDE PANELS (SEE CHART ON SHEETS 2,3&4)
 -VERTICAL CABLE MANAGEMENT FINGERS (SEE CHART ON SHEETS 2,3&4)
 -CABINET HARDWARE KIT
 -INSTRUCTION SHEET
7. RACK UNIT SPACING NUMERALS ARE CLEARLY PRINTED ON EQUIPMENT MOUNTING RAILS.
8. FULLY BONDED STRUCTURE WHEN ASSEMBLED PER INSTRUCTIONS.
9. STATIC LOAD RATING: 1360 Kg (3000 LBS)
10. ROLLING LOAD RATING: 1133 Kg (2500 LBS)
11. SINGLE POINT GROUND LOCATIONS AT TOP AND BOTTOM OF CABINET.
12. ALL CABINET RAILS ARE INSTALLED NUMBERS UP.
13. MAXIMUM EQUIPMENT DEPTH, 992mm [39.06].

REV	DATE	BY	CHK	APR	DESCRIPTION	ECN
01B	02-10-16	SSP	DDW	TCN	A. CORRECTED CABLE OPENING QUANTITY, WAS (12)	V09000TW
01A	12-11-14	PBS	ADP	TCN	FLOOR MOUNT DIMENSIONS UPDATED	V09000BX
00C	12-17-13	PBS	ROJC	JDWE	REVISED CHART	12V305LV-DC
00B	5-20-13	PBS	NAGL	JDWE	REVISED CHART	12V305LV-DC
00A	8-13-12	TWV	JDW	JDWE	RELEASED TO PRODUCTION	12V305LV-DC

TITLE						NET-ACCESS N TYPE CABINET 800mm WIDE X 1200mm DEEP FAMILY			
						CUSTOMER DRAWING			
ITEM REVISION NAME						12V305LV/01.PRT			
DATASET FILE NAME						12V305LV_DC_01B.PRT			
						MATERIAL: N/A			
						DRAWING NUMBER: 12V305LV-DC			
DRAWN BY		DATE		CHK		SCALE		THIRD ANGLE PROJECTION	
TWV		8-13-12		JDW		NONE			
SHT 1 OF 7			SIZE						
			A						

THIS COPY IS PROVIDED ON A RESTRICTED BASIS AND IS NOT TO BE USED IN ANY WAY DETRIMENTAL TO THE INTERESTS OF PANDUIT CORP.

PART NO.	DESCRIPTION	DUAL HINGE DOOR	SPLIT DOOR	SINGLE HINGE DOOR	SPLIT SIDE PANEL	CAGE NUT E-RAIL (2-SETS)	TAPPED E-RAIL (2-SETS)	VERTICAL BLANKING PANELS	CABLE MANAGEMENT	CABINET WEIGHT FULLY UNPACKAGED	CABINET WEIGHT SHIPPING WEIGHT
N8222*	NET-ACCESS N-TYPE CABINET 42RUX1200mm DEEP	01	01	00	02	00	01	00	02	140 Kg/EACH 310 LBS/EACH	161 Kg/EACH 355 LBS/EACH
N8522*	NET-ACCESS N-TYPE CABINET 45RUX1200mm DEEP	01	01	00	02	00	01	00	02	150 Kg/EACH 332 LBS/EACH	171 Kg/EACH 377 LBS/EACH
N8822*	NET-ACCESS N-TYPE CABINET 48RUX1200mm DEEP	01	01	00	02	00	01	00	02	160 Kg/EACH 354 LBS/EACH	181 Kg/EACH 399 LBS/EACH
N8229*	NET-ACCESS N-TYPE CABINET 42RUX1200mm DEEP	01	01	00	00	00	01	00	02	104 Kg/EACH 230 LBS/EACH	125 Kg/EACH 275 LBS/EACH
N8529*	NET-ACCESS N-TYPE CABINET 45RUX1200mm DEEP	01	01	00	00	00	01	00	02	111 Kg/EACH 245 LBS/EACH	131 Kg/EACH 290 LBS/EACH
N8829*	NET-ACCESS N-TYPE CABINET 48RUX1200mm DEEP	01	01	00	00	00	01	00	02	118 Kg/EACH 260 LBS/EACH	138 Kg/EACH 305 LBS/EACH
N8229*C	NET-ACCESS N-TYPE CABINET 42RUX1200mm DEEP	01	01	00	00	01	00	00	02	100 Kg/EACH 220 LBS/EACH	120 Kg/EACH 265 LBS/EACH
N8529*C	NET-ACCESS N-TYPE CABINET 45RUX1200mm DEEP	01	01	00	00	01	00	00	02	106 Kg/EACH 235 LBS/EACH	127 Kg/EACH 280 LBS/EACH
N8829*C	NET-ACCESS N-TYPE CABINET 48RUX1200mm DEEP	01	01	00	00	01	00	00	02	113 Kg/EACH 250 LBS/EACH	134 Kg/EACH 295 LBS/EACH
N8222*C	NET-ACCESS N-TYPE CABINET 42RUX1200mm DEEP	01	01	00	02	01	00	00	02	148 Kg/EACH 326 LBS/EACH	168 Kg/EACH 371 LBS/EACH
N8522*C	NET-ACCESS N-TYPE CABINET 45RUX1200mm DEEP	01	01	00	02	01	00	00	02	157 Kg/EACH 346 LBS/EACH	177 Kg/EACH 391 LBS/EACH
N8822*C	NET-ACCESS N-TYPE CABINET 48RUX1200mm DEEP	01	01	00	02	01	00	00	02	166 Kg/EACH 366 LBS/EACH	186 Kg/EACH 411 LBS/EACH
N8222*E	NET-ACCESS N-TYPE CABINET 42RUX1200mm DEEP	00	01	01	02	01	00	00	02	148 Kg/EACH 326 LBS/EACH	168 Kg/EACH 371 LBS/EACH
N8522*E	NET-ACCESS N-TYPE CABINET 45RUX1200mm DEEP	00	01	01	02	01	00	00	02	157 Kg/EACH 346 LBS/EACH	177 Kg/EACH 391 LBS/EACH
N8822*E	NET-ACCESS N-TYPE CABINET 48RUX1200mm DEEP	00	01	01	02	01	00	00	02	166 Kg/EACH 366 LBS/EACH	186 Kg/EACH 411 LBS/EACH
N8229*E	NET-ACCESS N-TYPE CABINET 42RUX1200mm DEEP	00	01	01	00	01	00	00	02	111 Kg/EACH 246 LBS/EACH	132 Kg/EACH 291 LBS/EACH
N8529*E	NET-ACCESS N-TYPE CABINET 45RUX1200mm DEEP	00	01	01	00	01	00	00	02	117 Kg/EACH 259 LBS/EACH	138 Kg/EACH 304 LBS/EACH

* DENOTES COLOR
 "B" = BLACK
 "W" = WHITE

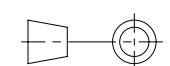
REV	DATE	BY	CHK	APR	DESCRIPTION	ECN	TWV	DATE	8-13-12	CHK	JDW	SCALE	NONE	SHT 2 OF 7	SIZE	A
							TITLE NET-ACCESS N TYPE CABINET 800mm WIDE X 1200mm DEEP FAMILY CUSTOMER DRAWING ITEM REVISION NAME 12V305LV/01.PRT DATASET FILE NAME 12V305LV_DC_01B.PRT MATERIAL: N/A DRAWING NUMBER: 12V305LV-DC  THIRD ANGLE PROJECTION									
01B	02-10-16	SSP	DDW	TCN	SEE SHEET 1 OF 7 FOR REVISIONS	V09000TW										
01A	12-11-14	PBS	ADP	TCN	SEE SHEET 1 OF 7 FOR REVISIONS	V09000BX										
00C	12-17-13	PBS	ROJC	JDWE	SEE SHEET 1 OF 7 FOR REVISIONS	12V305LV-DC										
00B	5-20-13	PBS	NAGL	JDWE	SEE SHEET 1 OF 6 FOR REVISIONS	12V305LV-DC										
00A	8-13-12	TWV	JDW	JDWE	SEE SHEET 1 OF 5 FOR REVISIONS	12V305LV-DC										

THIS COPY IS PROVIDED ON A RESTRICTED BASIS AND IS NOT TO BE USED IN ANY WAY DETRIMENTAL TO THE INTERESTS OF PANDUIT CORP.

PART NO.	DESCRIPTION	DUAL HINGE DOOR	SPLIT DOOR	SINGLE HINGE DOOR	SPLIT SIDE PANEL	CAGE NUT E-RAIL (2-SETS)	TAPPED E-RAIL (2-SETS)	VERTICAL BLANKING PANELS	CABLE MANAGEMENT	CABINET WEIGHT FULLY UNPACKAGED	CABINET WEIGHT SHIPPING WEIGHT
N8829*E	NET-ACCESS N-TYPE CABINET 48RUX1200mm DEEP	00	01	01	00	01	00	00	02	123 Kg/EACH 272 LBS/EACH	144 Kg/EACH 317 LBS/EACH
N8222*S	NET-ACCESS N-TYPE CABINET 42RUX1200mm DEEP	00	00	00	02	00	01	00	02	116 Kg/EACH 255 LBS/EACH	136 Kg/EACH 300 LBS/EACH
N8522*S	NET-ACCESS N-TYPE CABINET 45RUX1200mm DEEP	00	00	00	02	00	01	00	02	126 Kg/EACH 277 LBS/EACH	146 Kg/EACH 322 LBS/EACH
N8822*S	NET-ACCESS N-TYPE CABINET 48RUX1200mm DEEP	00	00	00	02	00	01	00	02	135 Kg/EACH 299 LBS/EACH	156 Kg/EACH 344 LBS/EACH
N8229*S	NET-ACCESS N-TYPE CABINET 42RUX1200mm DEEP	00	00	00	00	00	01	00	02	79 Kg/EACH 175 LBS/EACH	100 Kg/EACH 220 LBS/EACH
N8529*S	NET-ACCESS N-TYPE CABINET 45RUX1200mm DEEP	00	00	00	00	00	01	00	02	86 Kg/EACH 190 LBS/EACH	106 Kg/EACH 235 LBS/EACH
N8829*S	NET-ACCESS N-TYPE CABINET 48RUX1200mm DEEP	00	00	00	00	00	01	00	02	93 Kg/EACH 205 LBS/EACH	113 Kg/EACH 250 LBS/EACH
N8222*U	NET-ACCESS N-TYPE CABINET 42RUX1200mm DEEP	01	01	00	02	01	00	01	02	140 Kg/EACH 310 LBS/EACH	161 Kg/EACH 355 LBS/EACH
N8522*U	NET-ACCESS N-TYPE CABINET 45RUX1200mm DEEP	01	01	00	02	01	00	01	02	150 Kg/EACH 332 LBS/EACH	171 Kg/EACH 377 LBS/EACH
N8822*U	NET-ACCESS N-TYPE CABINET 48RUX1200mm DEEP	01	01	00	02	01	00	01	02	160 Kg/EACH 354 LBS/EACH	181 Kg/EACH 399 LBS/EACH
N8229*U	NET-ACCESS N-TYPE CABINET 42RUX1200mm DEEP	01	01	00	00	01	00	01	02	104 Kg/EACH 230 LBS/EACH	125 Kg/EACH 275 LBS/EACH
N8529*U	NET-ACCESS N-TYPE CABINET 45RUX1200mm DEEP	01	01	00	00	01	00	01	02	111 Kg/EACH 245 LBS/EACH	131 Kg/EACH 290 LBS/EACH
N8829*U	NET-ACCESS N-TYPE CABINET 48RUX1200mm DEEP	01	01	00	00	01	00	01	02	118 Kg/EACH 260 LBS/EACH	138 Kg/EACH 305 LBS/EACH
N8222*J	NET-ACCESS N-TYPE CABINET 42RUX1200mm DEEP	00	02	00	02	00	01	00	02	136 Kg/EACH 300 LBS/EACH	156 Kg/EACH 345 LBS/EACH
N8522*J	NET-ACCESS N-TYPE CABINET 45RUX1200mm DEEP	00	02	00	02	00	01	00	02	146 Kg/EACH 322 LBS/EACH	166 Kg/EACH 367 LBS/EACH
N8822*J	NET-ACCESS N-TYPE CABINET 48RUX1200mm DEEP	00	02	00	02	00	01	00	02	156 Kg/EACH 344 LBS/EACH	176 Kg/EACH 389 LBS/EACH
N8229*J	NET-ACCESS N-TYPE CABINET 42RUX1200mm DEEP	00	02	00	00	00	01	00	02	100 Kg/EACH 220 LBS/EACH	120 Kg/EACH 265 LBS/EACH

* DENOTES COLOR
 B = BLACK
 W = WHITE

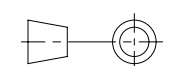
REV	DATE	BY	CHK	APR	DESCRIPTION	ECN	TWV	DATE	8-13-12	CHK	JDW	SCALE	NONE	SHT 3 OF 7	SIZE	A
							TITLE NET-ACCESS N TYPE CABINET 800mm WIDE X 1200mm DEEP FAMILY CUSTOMER DRAWING ITEM REVISION NAME 12V305LV/01.PRT DATASET FILE NAME 12V305LV_DC_01B.PRT MATERIAL: N/A DRAWING NUMBER: 12V305LV-DC  THIRD ANGLE PROJECTION									
01B	02-10-16	SSP	DDW	TCN	SEE SHEET 1 OF 7 FOR REVISIONS	V09000TW										
01A	12-11-14	PBS	ADP	TCN	SEE SHEET 1 OF 7 FOR REVISIONS	V09000BX										
00C	12-17-13	PBS	ROJC	JDWE	SEE SHEET 1 OF 7 FOR REVISIONS	12V305LV-DC										
00B	5-20-13	PBS	NAGL	JDWE	SEE SHEET 1 OF 6 FOR REVISIONS	12V305LV-DC										
00A	8-13-12	TWV	JDW	JDWE	SEE SHEET 1 OF 5 FOR REVISIONS	12V305LV-DC										

THIS COPY IS PROVIDED ON A RESTRICTED BASIS AND IS NOT TO BE USED IN ANY WAY DETRIMENTAL TO THE INTERESTS OF PANDUIT CORP.

PART NO.	DESCRIPTION	DUAL HINGE DOOR	SPLIT DOOR	SINGLE HINGE DOOR	SPLIT SIDE PANEL	CAGE NUT E-RAIL (2-SETS)	TAPPED E-RAIL (2-SETS)	VERTICAL BLANKING PANELS	CABLE MANAGEMENT	CABINET WEIGHT FULLY UNPACKAGED	CABINET WEIGHT SHIPPING WEIGHT
N8529*J	NET-ACCESS N-TYPE CABINET 45RUX1200mm DEEP	00	02	00	00	00	01	00	02	107 Kg/EACH 235 LBS/EACH	127 Kg/EACH 280 LBS/EACH
N8829*J	NET-ACCESS N-TYPE CABINET 48RUX1200mm DEEP	00	02	00	00	00	01	00	02	113 Kg/EACH 250 LBS/EACH	134 Kg/EACH 295 LBS/EACH
N8222*M	NET-ACCESS N-TYPE CABINET 42RUX1200mm DEEP	01	01	00	02	00	01	01	02	149 Kg/EACH 329 LBS/EACH	170 Kg/EACH 374 LBS/EACH
N8522*M	NET-ACCESS N-TYPE CABINET 45RUX1200mm DEEP	01	01	00	02	00	01	01	02	159 Kg/EACH 351 LBS/EACH	180 Kg/EACH 396 LBS/EACH
N8822*M	NET-ACCESS N-TYPE CABINET 48RUX1200mm DEEP	01	01	00	02	00	01	01	02	169 Kg/EACH 373 LBS/EACH	190 Kg/EACH 418 LBS/EACH
N8229*M	NET-ACCESS N-TYPE CABINET 42RUX1200mm DEEP	01	01	00	00	00	01	01	02	113 Kg/EACH 249 LBS/EACH	133 Kg/EACH 294 LBS/EACH
N8529*M	NET-ACCESS N-TYPE CABINET 45RUX1200mm DEEP	01	01	00	00	00	01	01	02	120 Kg/EACH 264 LBS/EACH	140 Kg/EACH 309 LBS/EACH
N8829*M	NET-ACCESS N-TYPE CABINET 48RUX1200mm DEEP	01	01	00	00	00	01	01	02	127 Kg/EACH 279 LBS/EACH	147 Kg/EACH 324 LBS/EACH

* DENOTES COLOR
 "B" = BLACK
 "W" = WHITE

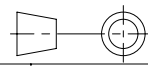
REV	DATE	BY	CHK	APR	DESCRIPTION	ECN	TWV	DATE	8-13-12	CHK	JDW	SCALE	NONE	SHT 4 OF 7	SIZE	A
							TITLE NET-ACCESS N TYPE CABINET 800mm WIDE X 1200mm DEEP FAMILY CUSTOMER DRAWING									
							ITEM REVISION NAME 12V305LV/01.PRT									
							DATASET FILE NAME 12V305LV_DC_01B.PRT									
							MATERIAL: N/A					DRAWING NUMBER: 12V305LV-DC				
							 THIRD ANGLE PROJECTION									

THIS COPY IS PROVIDED ON A RESTRICTED BASIS AND IS NOT TO BE USED IN ANY WAY DETRIMENTAL TO THE INTERESTS OF PANDUIT CORP.

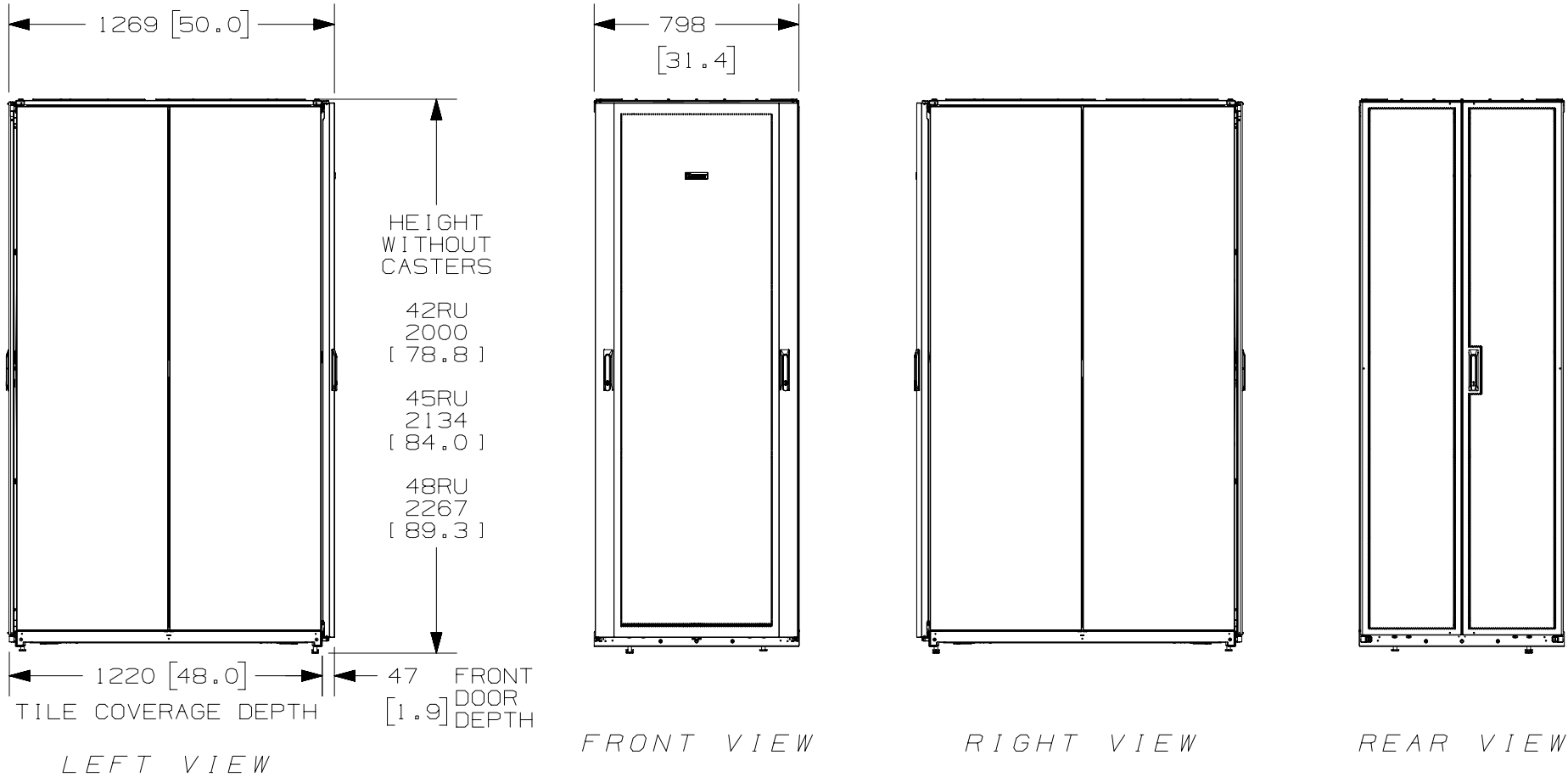

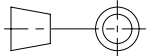
REV	DATE	BY	CHK	APR	DESCRIPTION	ECN	TITLE				DRAWING NUMBER:	
							NET-ACCESS N TYPE CABINET 800mm WIDE X 1200mm DEEP FAMILY				12V305LV-DC	
							CUSTOMER DRAWING				N/A	
							ITEM REVISION NAME				MATERIAL:	
01B	02-10-16	SSP	DDW	TCN	SEE SHEET 1 OF 7 FOR REVISIONS	V09000TW	12V305LV/01.PRT				PANDUIT	
01A	12-11-14	PBS	ADP	TCN	SEE SHEET 1 OF 7 FOR REVISIONS	V09000BX	DATASET FILE NAME				DRAWING NUMBER:	
00C	12-17-13	PBS	ROJC	JDWE	SEE SHEET 1 OF 7 FOR REVISIONS	12V305LV-DC	12V305LV_DC_01B.PRT				12V305LV-DC	
00B	5-20-13	PBS	NAGL	JDWE	SEE SHEET 1 OF 6 FOR REVISIONS	12V305LV-DC	 THIRD ANGLE PROJECTION				12V305LV-DC	
00A	8-13-12	TWV	JDW	JDWE	SEE SHEET 1 OF 5 FOR REVISIONS	12V305LV-DC						
							DRAWN BY	DATE	CHK	SCALE	SIZE	
							TWV	8-13-12	JDW	NONE	A	

THIS COPY IS PROVIDED ON A RESTRICTED BASIS AND IS NOT TO BE USED IN ANY WAY DETRIMENTAL TO THE INTERESTS OF PANDUIT CORP.

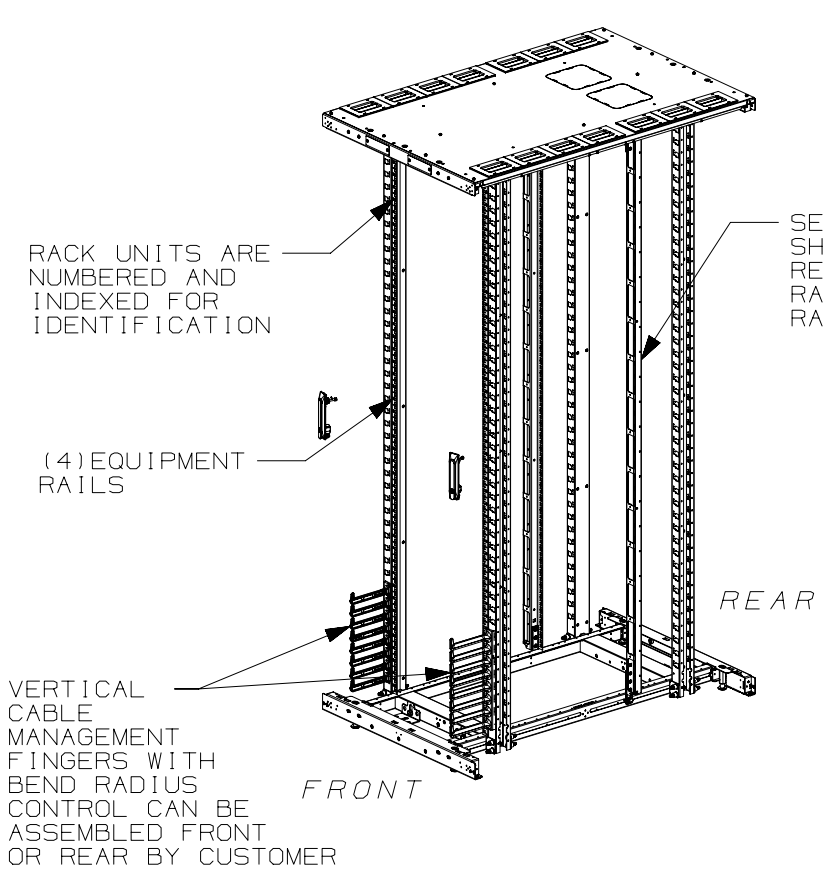

(6) LOCATIONS TAPPED FOR M10 THREADED ROD

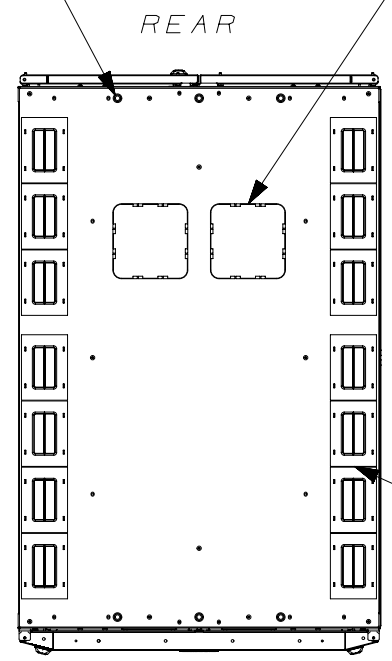

(2) 165mm X 165mm [6.5in] [6.5in] KNOCKOUTS FOR PDU POWER CORDS. COMPATIBLE W/ COOL BOOT P/N: CTGN6X6

(14) CABLE OPENINGS (83mm X 120mm) [3.26in] [4.7in] WITH BEZELS AND COVERS. COMPATIBLE W/ COOL BOOT P/N: CTGN3X5

FRONT DOOR, REAR DOOR, AND SIDE PANELS NOT SHOWN

REV	DATE	BY	CHK	APR	DESCRIPTION	ECN
01B	02-10-16	SSP	DDW	TCN	SEE SHEET 1 OF 7 FOR REVISIONS	V09000TW
01A	12-11-14	PBS	ADP	TCN	SEE SHEET 1 OF 7 FOR REVISIONS	V09000BX
00C	12-17-13	PBS	ROJC	JDWE	SEE SHEET 1 OF 7 FOR REVISIONS	12V305LV-DC
00B	5-20-13	PBS	NAGL	JDWE	SEE SHEET 1 OF 6 FOR REVISIONS	12V305LV-DC
00A	8-13-12	TWV	JDW	JDWE	SEE SHEET 1 OF 5 FOR REVISIONS	12V305LV-DC

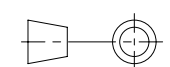
TITLE		NET-ACCESS N TYPE CABINET 800mm WIDE X 1200mm DEEP FAMILY		
		CUSTOMER DRAWING		
ITEM REVISION NAME		12V305LV/01.PRT		
DATASET FILE NAME		12V305LV_DC_01B.PRT		
				
		MATERIAL: N/A		
		DRAWING NUMBER: 12V305LV-DC		
DRAWN BY		DATE	CHK	SCALE
T WV		8-13-12	JDW	NONE
				
		THIRD ANGLE PROJECTION		
SHT 6 OF 7		A		

THIS COPY IS PROVIDED ON A RESTRICTED BASIS AND IS NOT TO BE USED IN ANY WAY DETRIMENTAL TO THE INTERESTS OF PANDUIT CORP.

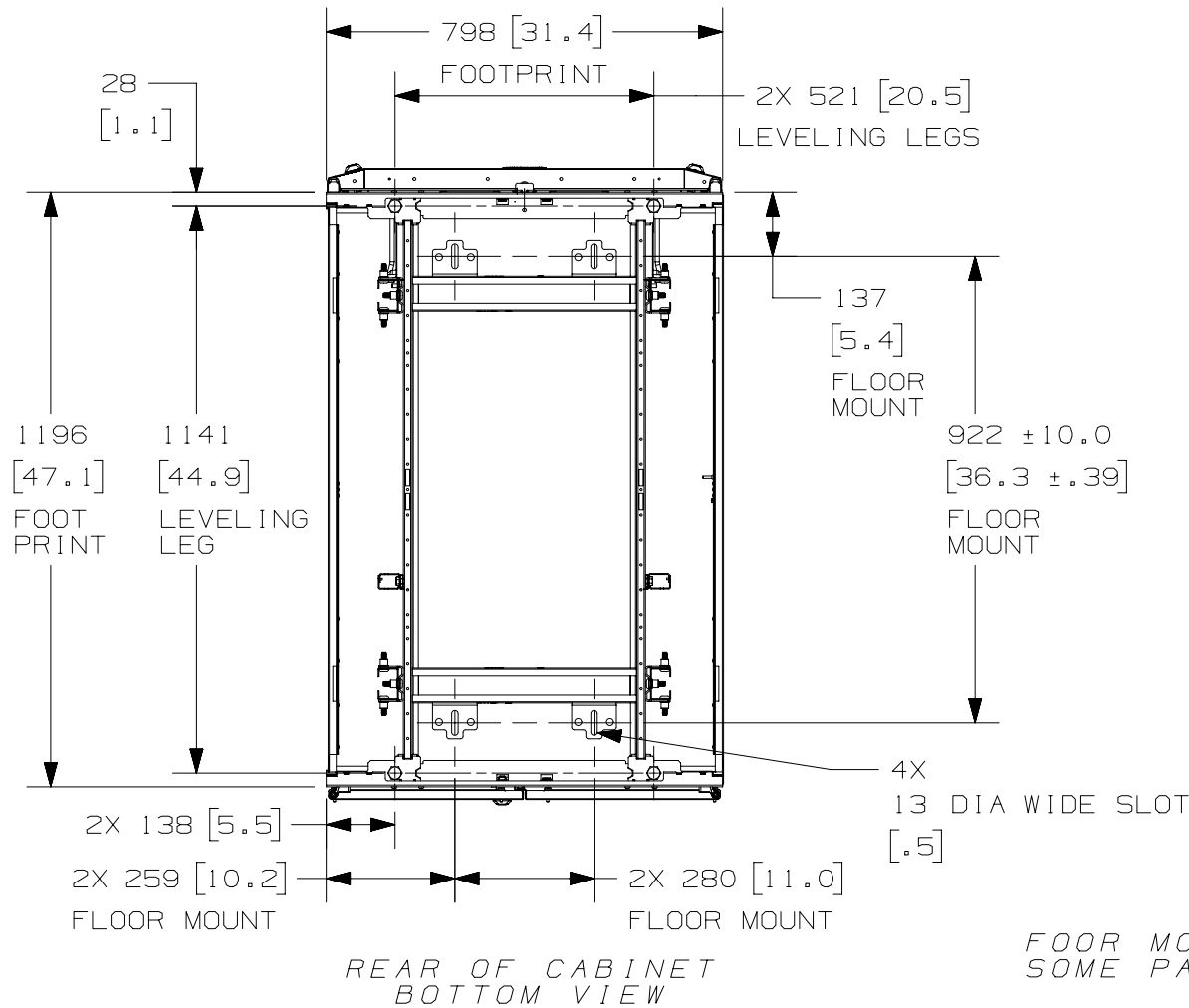

REV	DATE	BY	CHK	APR	DESCRIPTION	ECN
01B	02-10-16	SSP	DDW	TCN	SEE SHEET 1 OF 7 FOR REVISIONS	V09000TW
01A	12-11-14	PBS	ADP	TCN	SEE SHEET 1 OF 7 FOR REVISIONS	V09000BX
00C	12-17-13	PBS	ROJC	JDWE	SEE SHEET 1 OF 7 FOR REVISIONS	12V305LV-DC
00B	5-20-13	PBS	NAGL	JDWE	SEE SHEET 1 OF 6 FOR REVISIONS	12V305LV-DC
00A	8-13-12	TWV	JDW	JDWE	SEE SHEET 1 OF 5 FOR REVISIONS	12V305LV-DC

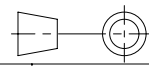
TITLE		NET-ACCESS N TYPE CABINET 800mm WIDE X 1200mm DEEP FAMILY		
		CUSTOMER DRAWING		
ITEM REVISION NAME		12V305LV/01.PRT		
DATASET FILE NAME		12V305LV_DC_01B.PRT		
				
		MATERIAL: N/A		
		DRAWING NUMBER: 12V305LV-DC		
DRAWN BY		DATE	CHK	SCALE
T WV		8-13-12	JDW	NONE
				
		THIRD ANGLE PROJECTION		
REV		DATE	BY	CHK
SHT 7 OF 7				A