

Chip LEDs with Reflector 1208<3.0×2.0 t=1.3mm> Medium / High Brightness Type



SML-01 * Series

Emitting Color	Blue	Green	Yellow	Orange	Red										
Material	InGaN on SiC			AlGaInP on GaAs											
Package Size(mm)															
Part No.	SML012BC4T	SML012BCT	SML013BDT	SML012EC4T	SML012ECT	SML012PT (A)	SML-011YT	SML-012YT	SML-012WT (A)	SML-011DT	SML-012DT	SML-011UT	SML-012UT	SML-012VT (A)	SML-013UT

note) "*" will be taken out for emitting color B/E series.

Absolute Maximum Ratings (Ta=25°C)

Part No.	Emitting color	Power dissipation Pd (mW)	Forward current IF (mA)	Peak forward current I _{FP} * (mA)	Reverse voltage VR (V)	Operating temperature T _{opr} (°C)	Storage temperature T _{stg} (°C)
SML012BC4T	Blue	84	20	100		-30 to +85	
SML012BCT		78					
SML013BDT		78					
SML012EC4T	Green	84	25	60			
SML012ECT		62					
SML-012PT (A)	Yellow				5		-40 to +100
SML-011YT	Orange	75	30	100		-40 to +100	
SML-012YT							
SML-012WT (A)	Red					-30 to +85	
SML-011DT							
SML-012DT							
SML-011UT							
SML-012UT							
SML-012VT (A)							
SML-013UT							

*:Duty ≤1/10,1kHz.

Dimensions (Unit:mm)

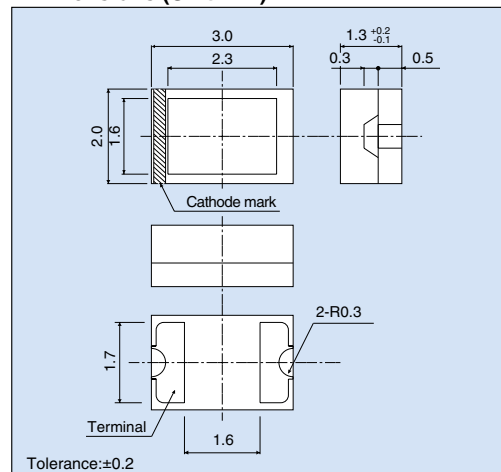

Electrical Optical Characteristics (Ta=25°C)

Part No.	Resin Color	Forward voltage VF		Reverse current IR		Light wavelength			Brightness Iv		
		Typ. (V)	IF (mA)	Max. (μA)	VR (V)	Peak λp (nm)	Half-wave Δλ (nm)	IF (mA)	Min. (mcd)	Typ. (mcd)	IF (mA)
SML012BC4T	Transparent Colorless	3.2	20	100	5	468	26	20	22	36	20
SML012BCT		3.3							36	100	
SML013BDT		3.2							90	250	
SML012EC4T	Transparent Colorless	3.2	20	10	5	523	36	20	56	140	20
SML012ECT		3.3							140	360	
SML-012PT (A)	Transparent Colorless	2.1	20	10	5	518	35	20	9.0	18	20
SML-011YT		565							36	63	
SML-012YT	Transparent Colorless	2.0	20	10	5	590	15	20	22	63	20
SML-012WT (A)									36	100	
SML-011DT	Transparent Colorless	2.0	20	10	5	611	17	20	140	280	20
SML-012DT									22	63	
SML-011UT	Transparent Colorless	2.0	20	10	5	630	18	20	36	100	20
SML-012UT									22	63	
SML-012VT (A)	Transparent Colorless	2.0	20	10	5	639	-	20	35.5	71	20
SML-013UT									90	220	

*1:Pulse width : 30ms *2: Dominant λD light wavelength

Directivity (Typ.)

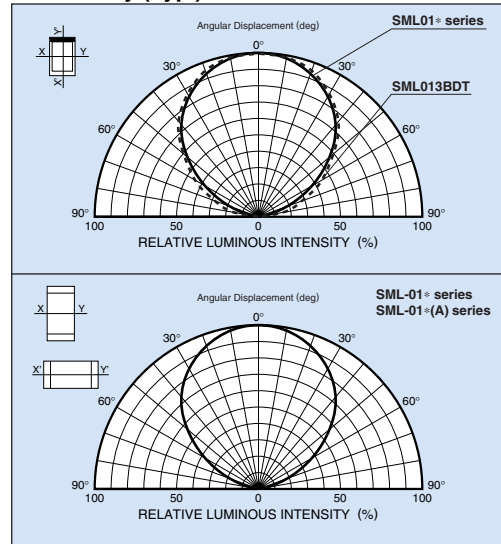

Recommended Pad Layout

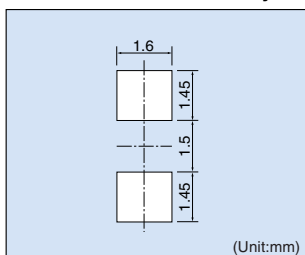

The recommended thickness of the screen mask for soldering is between 100 and 150μm. The hole size of the screen mask should be same as the recommended land pattern or smaller.

Packaging Specifications (Unit:mm)

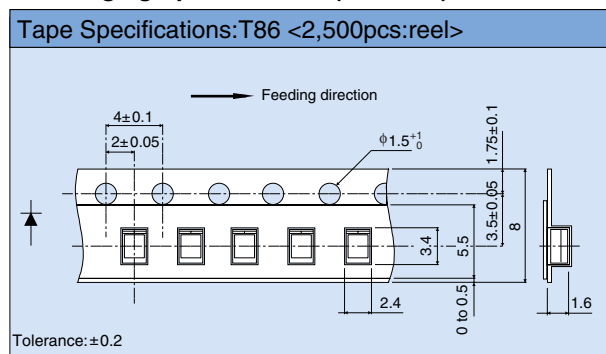

Reel Specifications

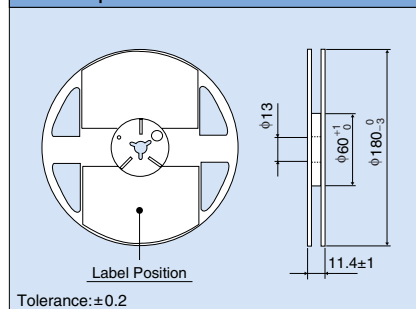

Electrical Characteristic Curves

Forward Current - Forward Voltage

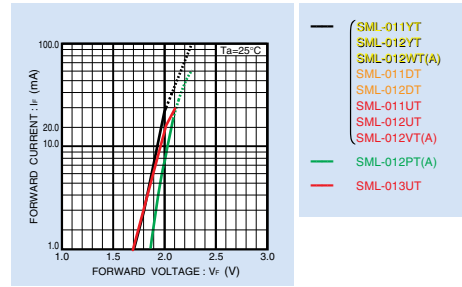
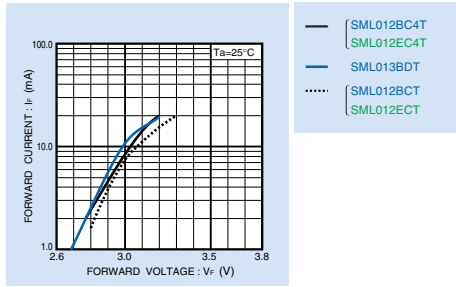

Relative Luminous Intensity - Case Temperature

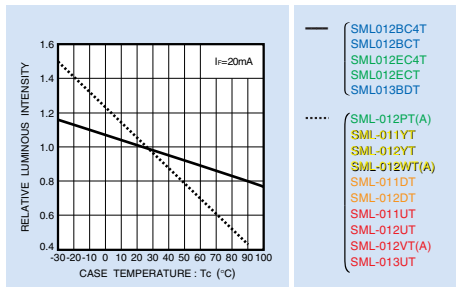

Relative Luminous Intensity - Forward Current

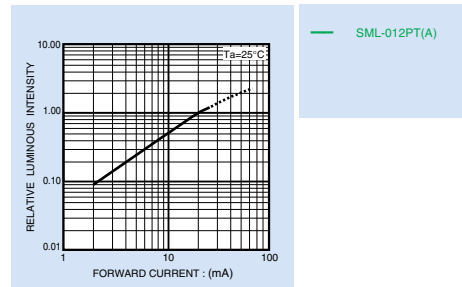

Relative Luminous Intensity - Forward Current

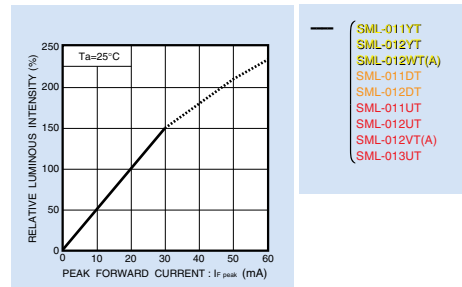
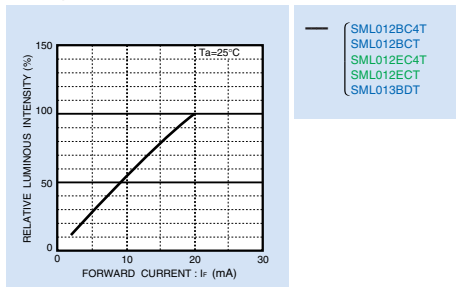

Ratio of Maximum Tolerable Peak Current - Pulse Duration

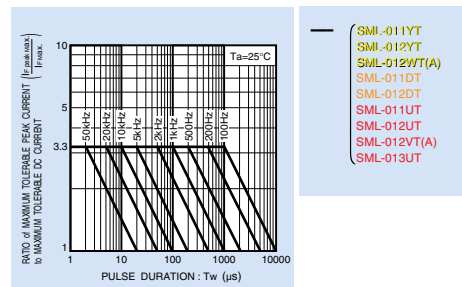
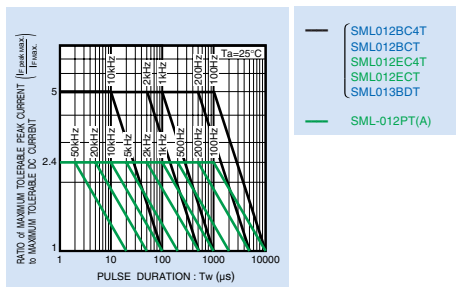

Derating

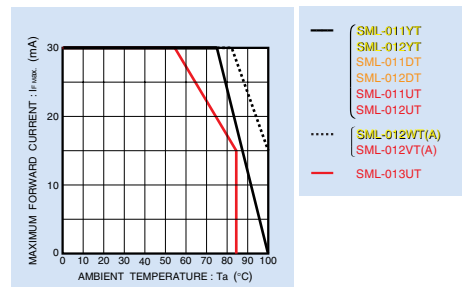
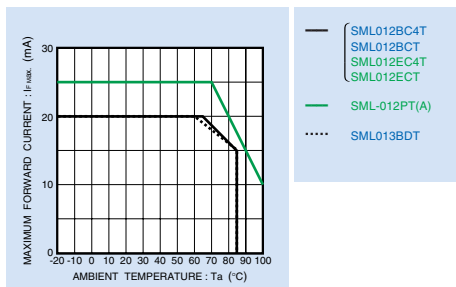

Notes

- No technical content pages of this document may be reproduced in any form or transmitted by any means without prior permission of ROHM CO.,LTD.
- The contents described herein are subject to change without notice. The specifications for the product described in this document are for reference only. Upon actual use, therefore, please request that specifications to be separately delivered.
- Application circuit diagrams and circuit constants contained herein are shown as examples of standard use and operation. Please pay careful attention to the peripheral conditions when designing circuits and deciding upon circuit constants in the set.
- Any data, including, but not limited to application circuit diagrams information, described herein are intended only as illustrations of such devices and not as the specifications for such devices. ROHM CO.,LTD. disclaims any warranty that any use of such devices shall be free from infringement of any third party's intellectual property rights or other proprietary rights, and further, assumes no liability of whatsoever nature in the event of any such infringement, or arising from or connected with or related to the use of such devices.
- Upon the sale of any such devices, other than for buyer's right to use such devices itself, resell or otherwise dispose of the same, no express or implied right or license to practice or commercially exploit any intellectual property rights or other proprietary rights owned or controlled by
- ROHM CO., LTD. is granted to any such buyer.
- Products listed in this document are no antiradiation design.

The products listed in this document are designed to be used with ordinary electronic equipment or devices (such as audio visual equipment, office-automation equipment, communications devices, electrical appliances and electronic toys).

Should you intend to use these products with equipment or devices which require an extremely high level of reliability and the malfunction of which would directly endanger human life (such as medical instruments, transportation equipment, aerospace machinery, nuclear-reactor controllers, fuel controllers and other safety devices), please be sure to consult with our sales representative in advance.

It is our top priority to supply products with the utmost quality and reliability. However, there is always a chance of failure due to unexpected factors. Therefore, please take into account the derating characteristics and allow for sufficient safety features, such as extra margin, anti-flammability, and fail-safe measures when designing in order to prevent possible accidents that may result in bodily harm or fire caused by component failure. ROHM cannot be held responsible for any damages arising from the use of the products under conditions out of the range of the specifications or due to non-compliance with the NOTES specified in this catalog.

Thank you for your accessing to ROHM product informations.

More detail product informations and catalogs are available, please contact your nearest sales office.

ROHM Customer Support System

THE AMERICAS / EUROPE / ASIA / JAPAN

www.rohm.com

Contact us : webmaster@rohm.co.jp