

0402<1.0×0.6 t=0.2mm> Low Current Type

SML-P11 Series

PICOLED™ - ECO

Emitting Color	Green(Yellowish Green)	Yellow	Orange	Red	
Material	AlGaInP on GaAs				
Package Size(mm)					
Part No.	SML-P11MT	SML-P11YT	SML-P11DT	SML-P11UT	SML-P11VT

Absolute Maximum Ratings (Ta=25°C)

Part No.	Emitting color	Power dissipation Pd (mW)	Forward current IF (mA)	Peak forward current *IFP (mA)	Reverse voltage VR (V)	Operating temperature Topr (C)	Storage temperature Tstg (C)
SML-P11MT	Green (Yellowish Green)	54					
SML-P11YT	Yellow	52					
SML-P11DT	Orange	52	20	100	5	-40 to +85	-40 to +100
SML-P11UT	Red	50					
SML-P11VT	Red	50					

*:Duty ≤1/10, 1kHz.

Dimensions (Unit:mm)

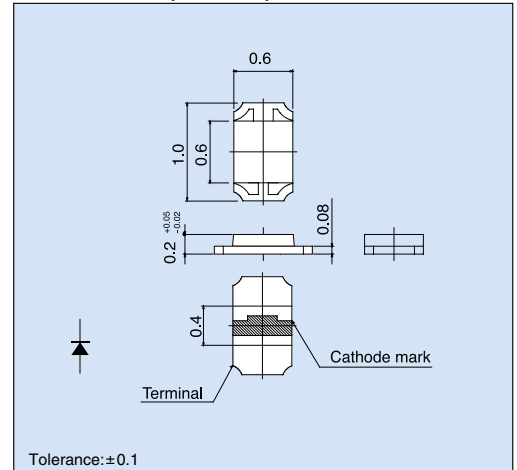

Electrical Optical Characteristics (Ta=25°C)

Part No.	Resin Color	Forward voltage VF		Reverse current IR		Light wavelength Dominant λD		Brightness Iv		
		Typ. (V)	IF (mA)	Max. (μA)	VR (V)	Typ. (nm)	IF (mA)	Min. (mcd)	Typ. (mcd)	IF (mA)
SML-P11MT	Transparent Colorless	1.9				569		0.63	2.1	
SML-P11YT		1.9				586		2.5	7.6	
SML-P11DT		1.8	1	100	4	605	1	2.5	7.3	1
SML-P11UT		1.8				621		1.6	5.5	
SML-P11VT		1.8				626		1.0	3.6	

Directivity (Typ.)

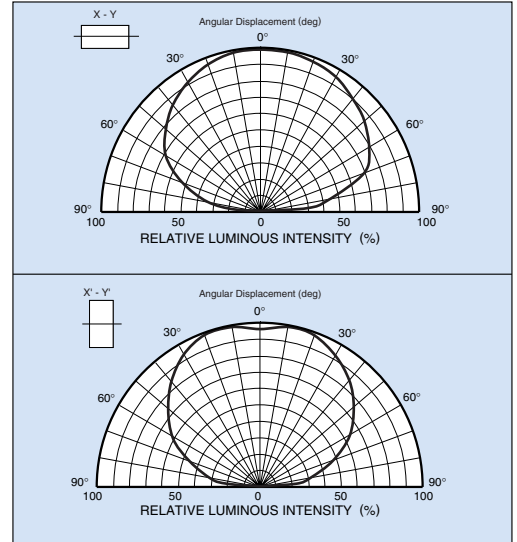

Recommended Pad Layout

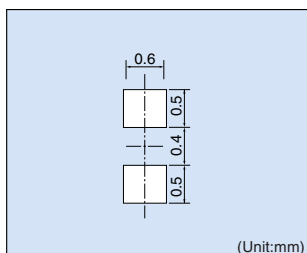

The recommended thickness of the screen mask for soldering is between 80 and 130μm. The hole size of the screen mask should be same as the recommended land pattern or smaller.

Packaging Specifications (Unit:mm)

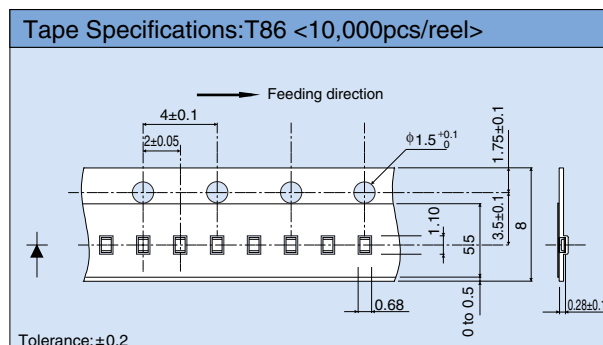

Reel Specifications

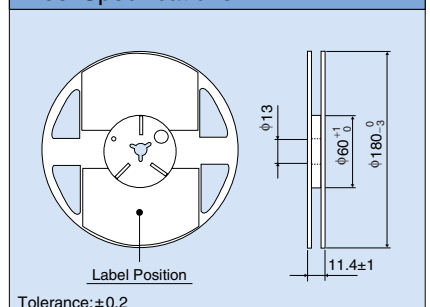

Electrical Characteristic Curves

Forward Current - Forward Voltage

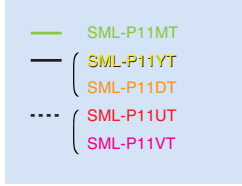
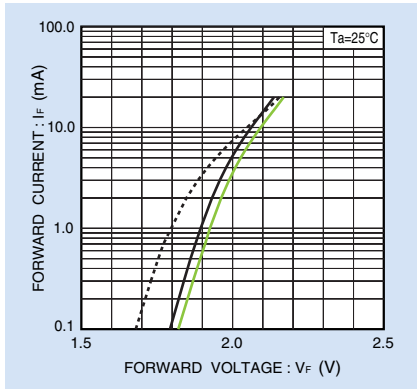

Relative Luminous Intensity - Case Temperature

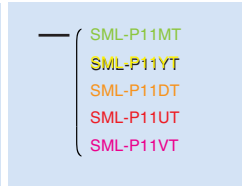
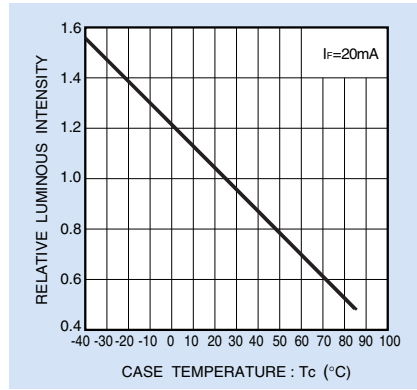

Relative Luminous Intensity - Forward Current

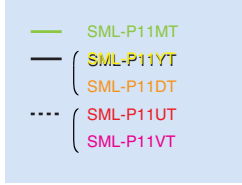
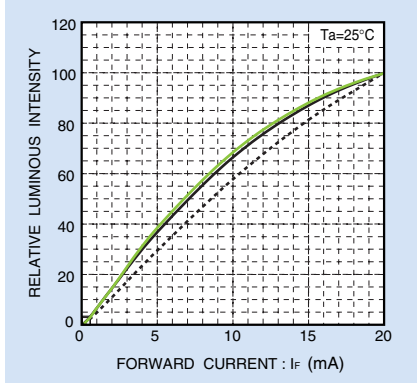

Ratio of Maximum Tolerable Peak Current - Pulse Duration

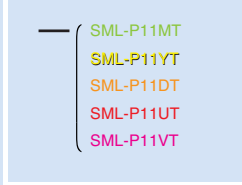
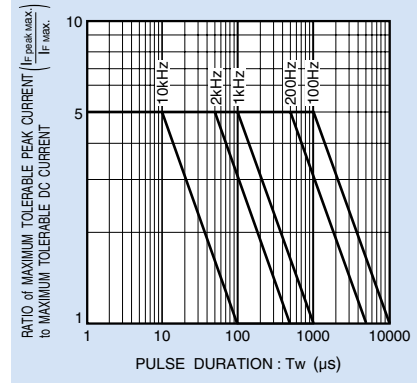

Derating

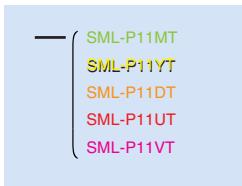
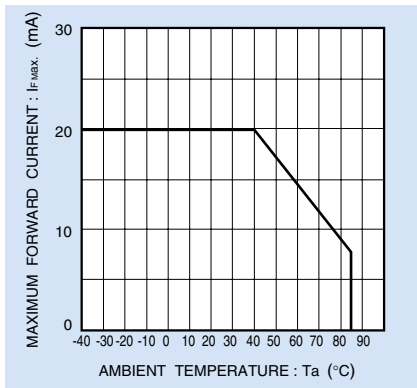

Notes

- No technical content pages of this document may be reproduced in any form or transmitted by any means without prior permission of ROHM CO.,LTD.
- The contents described herein are subject to change without notice. The specifications for the product described in this document are for reference only. Upon actual use, therefore, please request that specifications to be separately delivered.
- Application circuit diagrams and circuit constants contained herein are shown as examples of standard use and operation. Please pay careful attention to the peripheral conditions when designing circuits and deciding upon circuit constants in the set.
- Any data, including, but not limited to application circuit diagrams information, described herein are intended only as illustrations of such devices and not as the specifications for such devices. ROHM CO.,LTD. disclaims any warranty that any use of such devices shall be free from infringement of any third party's intellectual property rights or other proprietary rights, and further, assumes no liability of whatsoever nature in the event of any such infringement, or arising from or connected with or related to the use of such devices.
- Upon the sale of any such devices, other than for buyer's right to use such devices itself, resell or otherwise dispose of the same, no express or implied right or license to practice or commercially exploit any intellectual property rights or other proprietary rights owned or controlled by
- ROHM CO., LTD. is granted to any such buyer.
- Products listed in this document are no antiradiation design.

The products listed in this document are designed to be used with ordinary electronic equipment or devices (such as audio visual equipment, office-automation equipment, communications devices, electrical appliances and electronic toys).

Should you intend to use these products with equipment or devices which require an extremely high level of reliability and the malfunction of which would directly endanger human life (such as medical instruments, transportation equipment, aerospace machinery, nuclear-reactor controllers, fuel controllers and other safety devices), please be sure to consult with our sales representative in advance.

It is our top priority to supply products with the utmost quality and reliability. However, there is always a chance of failure due to unexpected factors. Therefore, please take into account the derating characteristics and allow for sufficient safety features, such as extra margin, anti-flammability, and fail-safe measures when designing in order to prevent possible accidents that may result in bodily harm or fire caused by component failure. ROHM cannot be held responsible for any damages arising from the use of the products under conditions out of the range of the specifications or due to non-compliance with the NOTES specified in this catalog.

Thank you for your accessing to ROHM product informations.

More detail product informations and catalogs are available, please contact your nearest sales office.

ROHM Customer Support System

THE AMERICAS / EUROPE / ASIA / JAPAN

www.rohm.com

Contact us : webmaster@rohm.co.jp