

●Features

- Ultra compact, thin size 1.0×0.6mm
- Original device technology enables high brightness and high reliability
- Lead Free/RoHS Compliant.

●Size

1006 (0402)
1.0 × 0.6mm (t=0.2mm)



●Outline

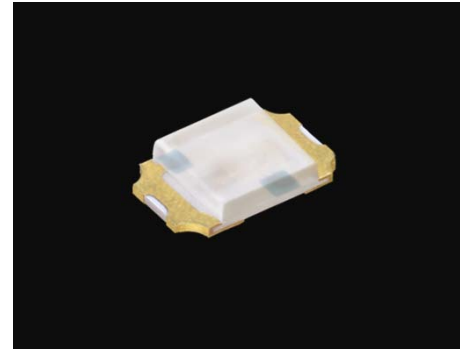

●Dimensions

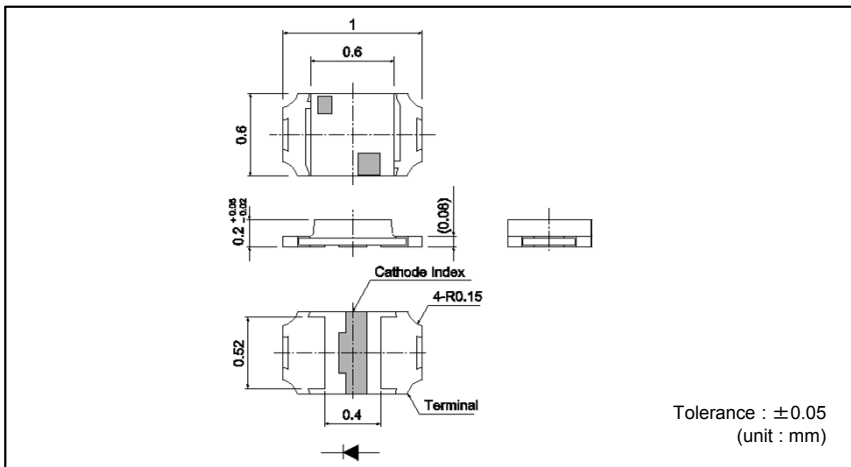

●Recommended Solder Pattern

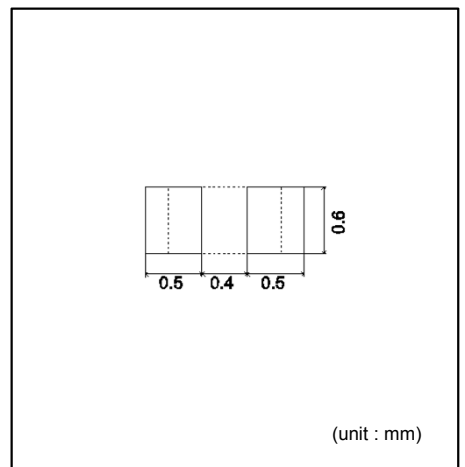

●Specifications

Part No.	Chip Structure	Emitting Color	Absolute Maximum Ratings (Ta=25°C)					Electrical and Optical Characteristics (Ta=25°C)											
			Power Dissipation P ₀ (mW)	Forward Current I _F (mA)	Peak Forward Current I _{FP} (mA)	Reverse Voltage V _R (V)	Operating Temp. Topr(°C)	Storage Temp. Tstg(°C)	Forward Voltage V _F		Reverse Current I _R		Dominant Wavelength λ _D			Luminous Intensity I _v ^{*3}			
								Typ. (V)	I _F (mA)	Max. (μA)	V _R (V)	Min. ^{*2} (nm)	Typ. (nm)	Max. ^{*2} (nm)	I _F (mA)	Min. (mcd)	Typ. (mcd)	I _F (mA)	
SML-P12VT8 (R)	AlGaInP on GaAs	Red	50	20	100 ^{*1}	5	-40 to +85	-40 to +100	2.0	20	10	5	625	630	635	20	25	60	20
SML-P12UT (R)													615	620	625		40	85	
SML-P12U2T (R)													610	615	620		25	70	
SML-P12DT (R)		Orange	52	20	100 ^{*1}	5	-40 to +85	-40 to +100	2.1	20	10	5	602	605	608	20	63	100	20
SML-P12Y3T (R)													593	596	599		40	90	
SML-P12YT (R)													587	590	593		40	100	
SML-P12WT (R)		Yellow	52	20	100 ^{*1}	5	-40 to +85	-40 to +100	2.1	20	10	5	582	585	588	20	25	70	20
SML-P12Y2T (R)													577	580	583		16	50	
SML-P12M2T (R)													573	576	579		10	25	
SML-P12MT (R)		Yellowish Green	54	20	100 ^{*1}	5	-40 to +85	-40 to +100	2.2	20	10	5	569	572	575	20	10	25	20
SML-P13FT (R)													563	566	569		6.3	18.0	
SML-P13PT (R)													557	560	563		4.0	10.0	
SMLP13EC8T		InGaN	Bluish Green	33	10	50 ^{*1}	5	-40 to +85	-40 to +100	3.0	5	100	5	520	527	535	5	56	110
SMLP13BC8T	Blue		465											470	475	9.0		25	
SCMP13WBC8W	White		(x, y) (0.30, 0.30)											90	150				

*1 : Duty 1/10, 1kHz *2 : Reference *3 : Measurement tolerance : ±10%

●Thermal Resistance

θ _{j-s}	θ _{j-a}
643°C/W	899°C/W

Conditions

Circuit Board	Glass epoxy circuit board
Circuit Board Dimensions	30×10×0.8mmt
Pad Size	1.5mm ² (Cathode)

*The above value is a result of actual measurement performed on randomly selected product. The value does not have any meanings of guarantee.

*PICOLED™ is ROHM's pending trademark.

●Electrical Characteristics Curves

reference

Fig.1 Forward Current - Forward Voltages

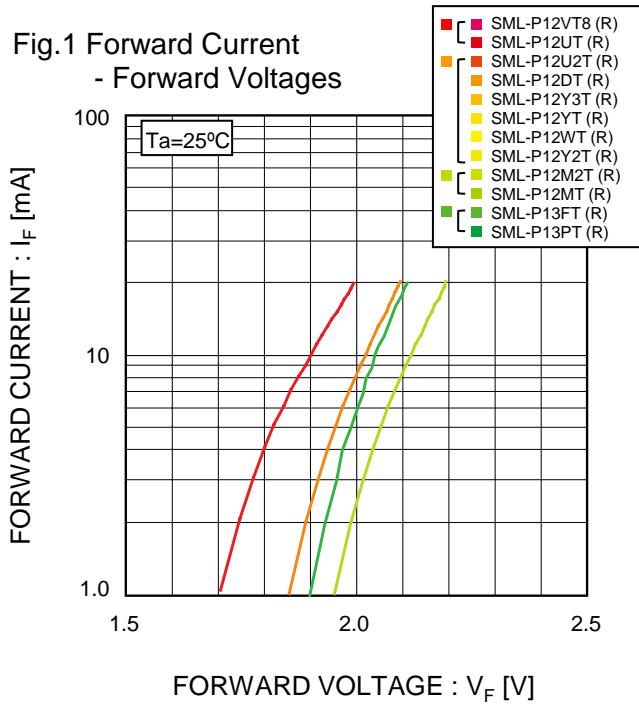

Fig.2 Luminous Intensity - Atmosphere Temperature

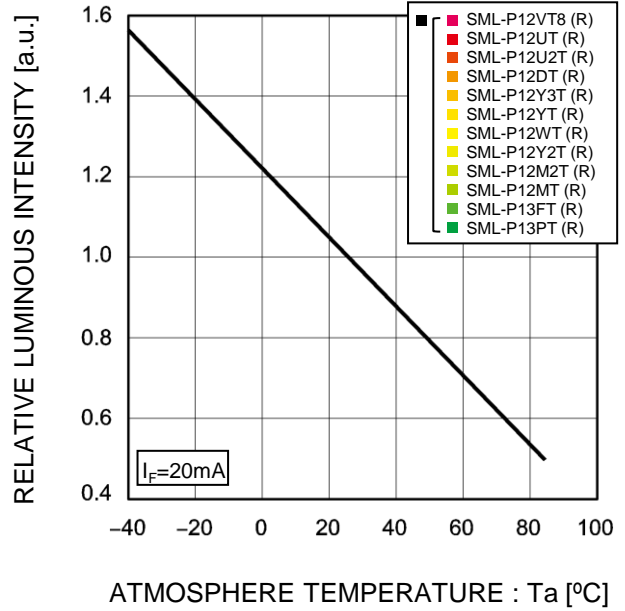

Fig.3 Luminous Intensity - Forward Current

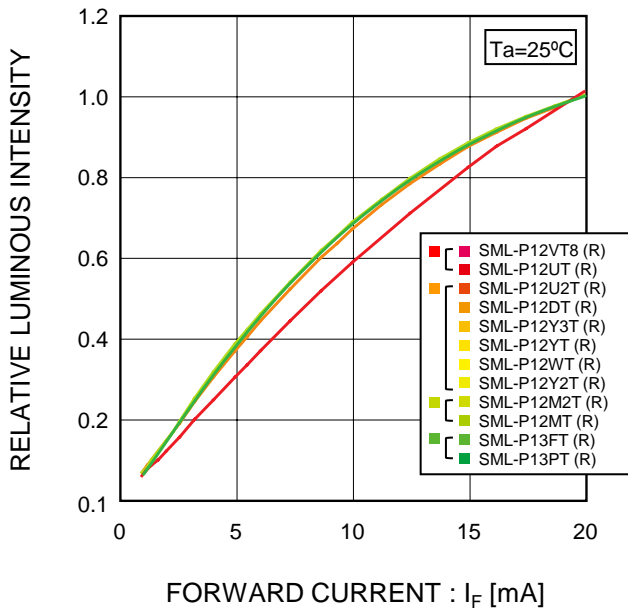
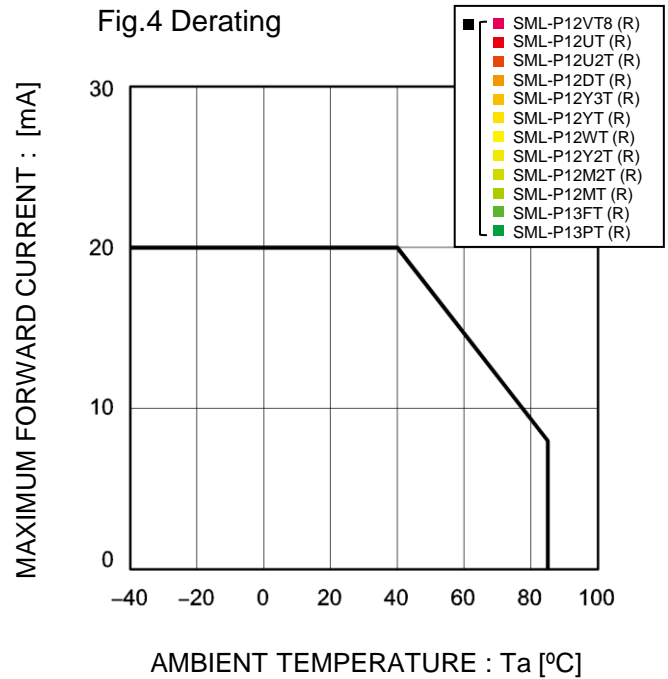

Fig.4 Derating



●Electrical Characteristics Curves

reference

Fig.1 Forward Current - Forward Voltages

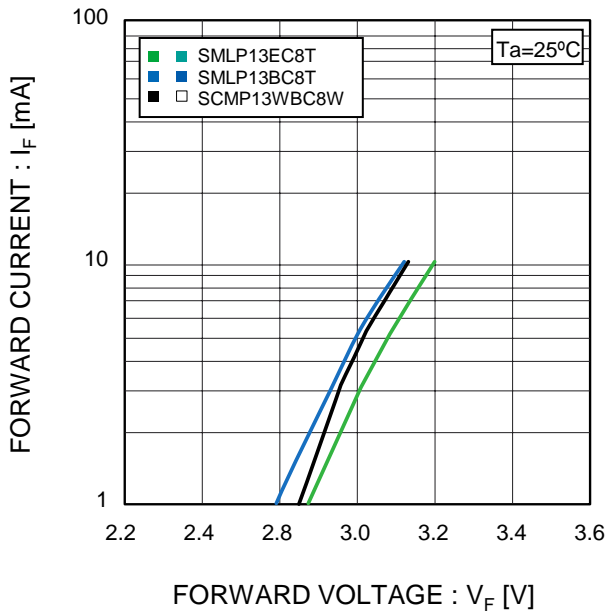
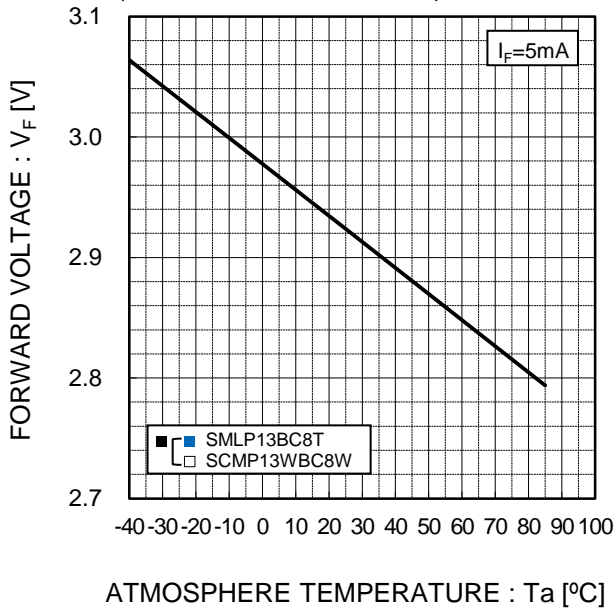
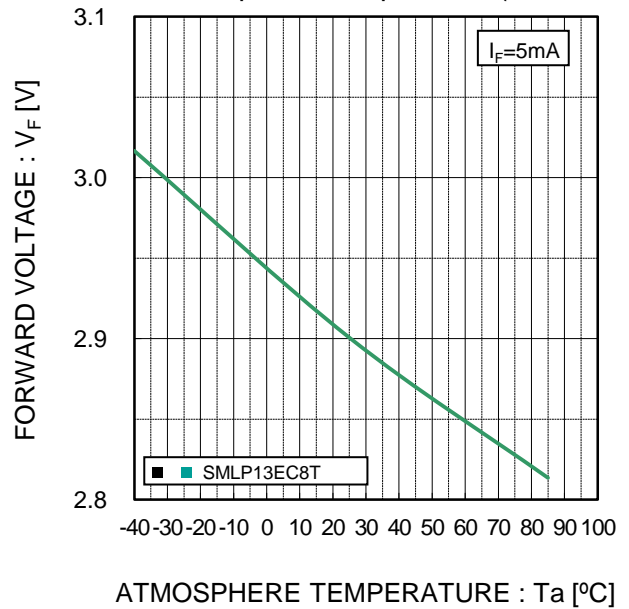

Fig.2-1 Forward Voltage - Atmosphere Temperature (P13BC8T, P13WBC8W)



* Please take this data as a reference data for the samples are measured randomly.

Fig.2-2 Forward Voltages - Atmosphere Temperature (P13EC8T)



* Please take this data as a reference data for the samples are measured randomly.

●Electrical Characteristics Curves

reference

Fig.3 Luminous Intensity - Atmosphere Temperature

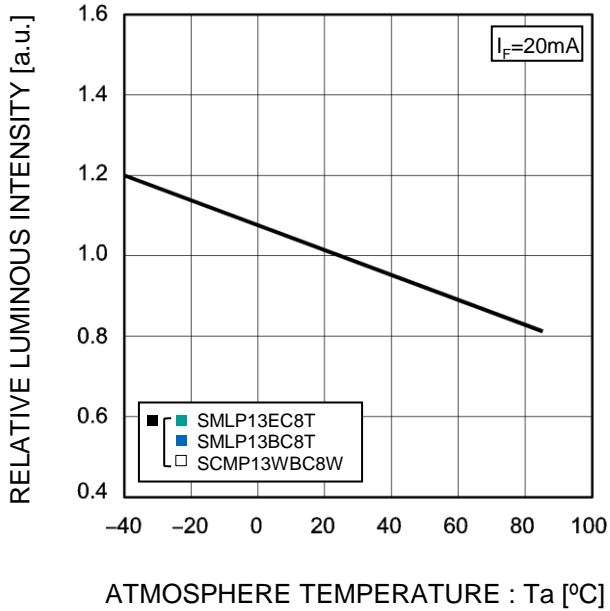

Fig.4 Luminous Intensity - Forward Current

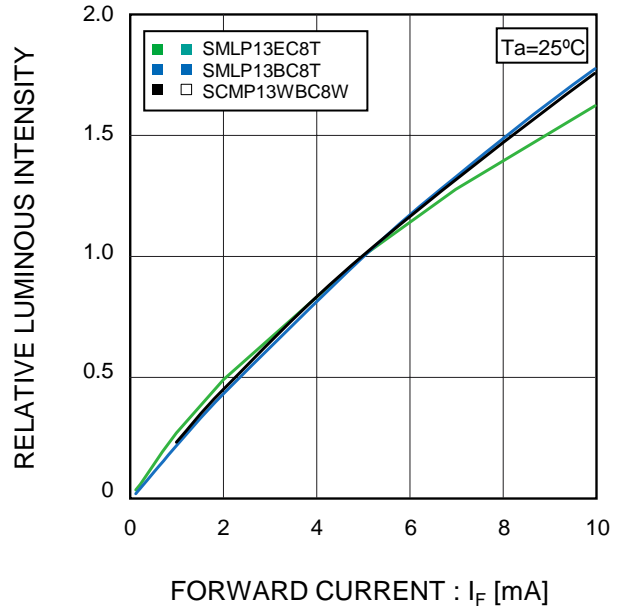
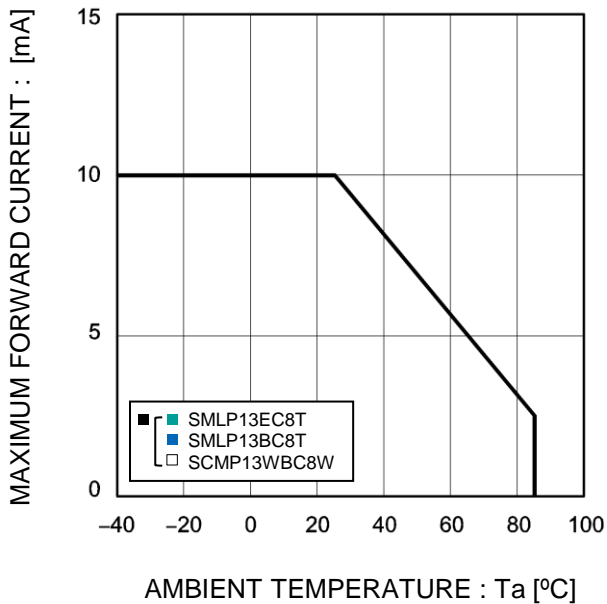
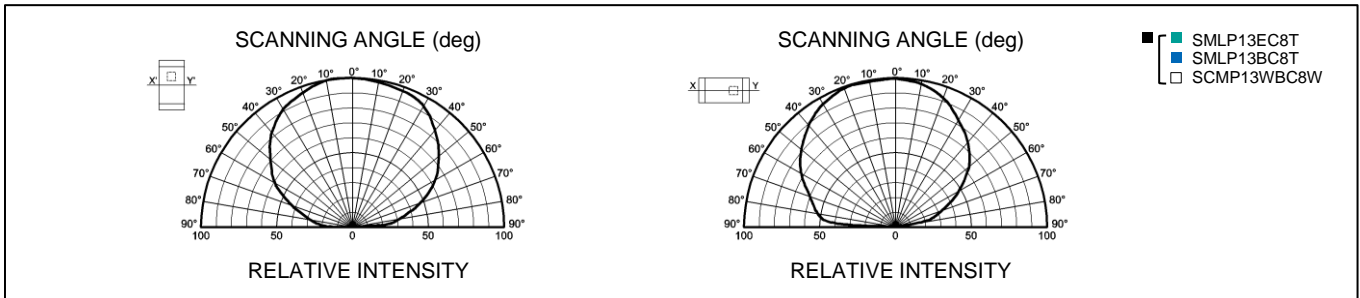
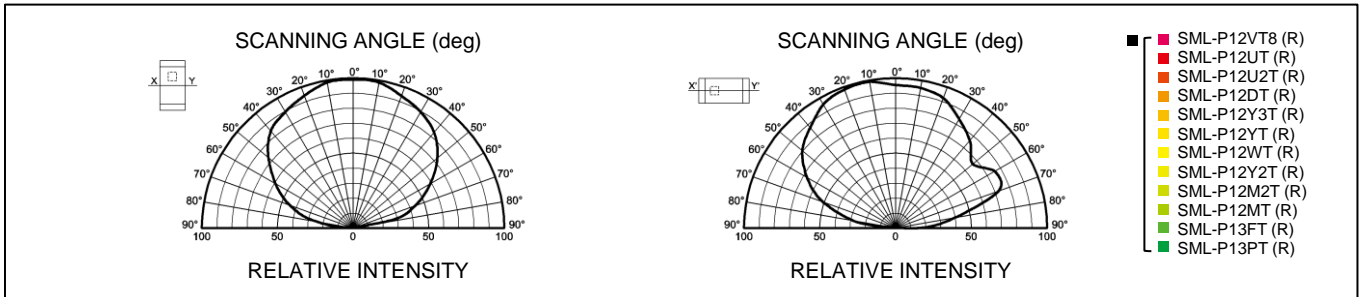

Fig.5 Derating



●Viewing Angle

reference



●Rank Reference of Brightness

Red(V,U,U2)

(Ta=25°C, If=20mA)

Rank	G	H	J	K	L	M	N	P	Q	R	S	T	U	V	W	X
Iv (mcd)	1.0 to 1.6	1.6 to 2.5	2.5 to 4.0	4.0 to 6.3	6.3 to 10	10 to 16	16 to 25	25 to 40	40 to 63	63 to 100	100 to 160	160 to 250	250 to 400	400 to 630	630 to 1000	1000 to 1600
SML-P12VT																
SML-P12UT																
SML-P12U2T																

Orange(D)

(Ta=25°C, If=20mA)

Rank	G	H	J	K	L	M	N	P	Q	R	S	T	U	V	W	X
Iv (mcd)	1.0 to 1.6	1.6 to 2.5	2.5 to 4.0	4.0 to 6.3	6.3 to 10	10 to 16	16 to 25	25 to 40	40 to 63	63 to 100	100 to 160	160 to 250	250 to 400	400 to 630	630 to 1000	1000 to 1600
SML-P12DT																

Yellow(Y3,Y,W,Y2)

(Ta=25°C, If=20mA)

Rank	G	H	J	K	L	M	N	P	Q	R	S	T	U	V	W	X
Iv (mcd)	1.0 to 1.6	1.6 to 2.5	2.5 to 4.0	4.0 to 6.3	6.3 to 10	10 to 16	16 to 25	25 to 40	40 to 63	63 to 100	100 to 160	160 to 250	250 to 400	400 to 630	630 to 1000	1000 to 1600
SML-P12Y3T																
SML-P12YT																
SML-P12WT																
SML-P12Y2T																

Green(M2,M,F,P)

(Ta=25°C, If=20mA)

Rank	G	H	J	K	L	M	N	P	Q	R	S	T	U	V	W	X
Iv (mcd)	1.0 to 1.6	1.6 to 2.5	2.5 to 4.0	4.0 to 6.3	6.3 to 10	10 to 16	16 to 25	25 to 40	40 to 63	63 to 100	100 to 160	160 to 250	250 to 400	400 to 630	630 to 1000	1000 to 1600
SML-P12M2T																
SML-P12MT																
SML-P13FT																
SML-P13PT																

Bluish Green(E)

(Ta=25°C, If=5mA)

Rank	G	H	J	K	L	M	N	P	Q	R	S	T	U	V	W
Iv (mcd)	0.9 to 1.4	1.4 to 2.2	2.2 to 3.6	3.6 to 5.6	5.6 to 9.0	9 to 14	14 to 22	22 to 36	36 to 56	56 to 90	90 to 140	140 to 220	220 to 360	360 to 560	560 to 900
SMLP13EC8T															

Blue(B)

(Ta=25°C, If=5mA)

Rank	G	H	J	K	L	M	N	P	Q	R	S	T	U	V	W
Iv (mcd)	0.9 to 1.4	1.4 to 2.2	2.2 to 3.6	3.6 to 5.6	5.6 to 9.0	9 to 14	14 to 22	22 to 36	36 to 56	56 to 90	90 to 140	140 to 220	220 to 360	360 to 560	560 to 900
SMLP13BC8T															

White(WB)

(Ta=25°C, If=5mA)

Rank	N	P	Q	R	S	T	U	V	W
Iv (mcd)	14 to 22	22 to 36	36 to 56	56 to 90	90 to 140	140 to 220	220 to 360	360 to 560	560 to 900
SCMP13WBC8W									

●Chromaticity Diagram

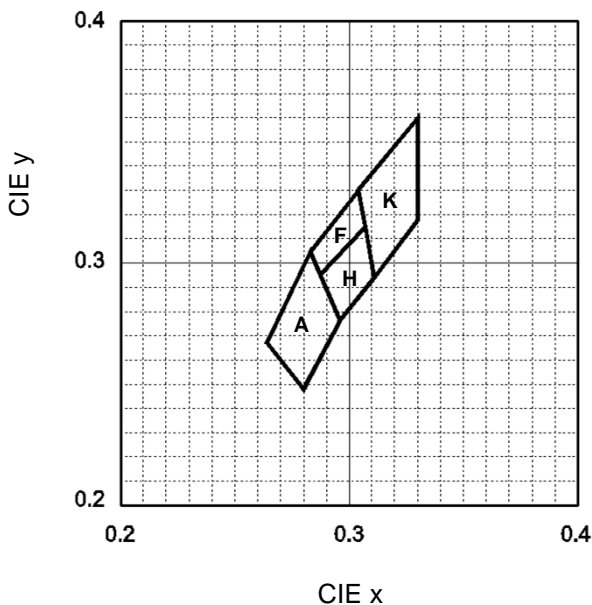

[Chromaticity Coordinates]

(Ta=25°C, If=5mA)

A		F		H		K	
x	y	x	y	x	y	x	y
0.28	0.248	0.283	0.305	0.287	0.295	0.304	0.33
0.296	0.276	0.304	0.33	0.307	0.315	0.33	0.36
0.283	0.305	0.307	0.315	0.311	0.294	0.33	0.318
0.264	0.267	0.287	0.295	0.296	0.276	0.311	0.294

Measurement tolerance : ±0.02

●Taping

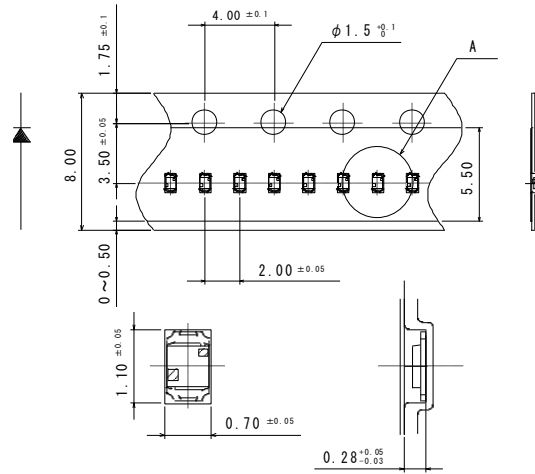

Enlarged drawing of "A"

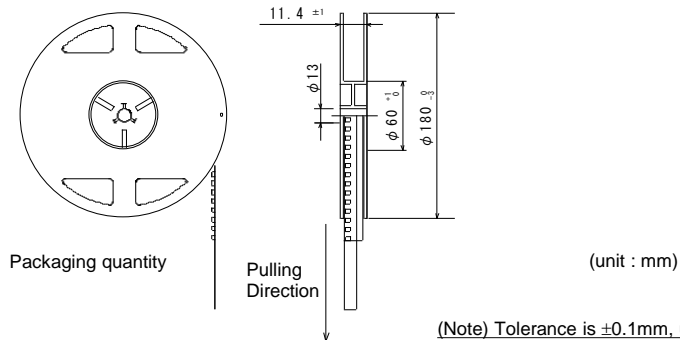

(Note) Tolerance is ±0.1mm, unless otherwise specified.

●Part No. Construction

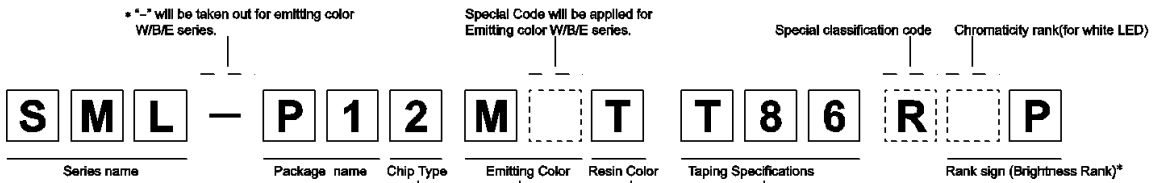

1	Low Current Type	V	Red:630nm	T	Transparent Colorless	T86	Cathode at sprocket hole side
2	High Brightness Type	U	Red:620nm	W	MilkyWhite	T87	Reverse of T86
		U2	Red:615nm			1	For white LED, cathode at sprocket hole side
		D	Orange:605nm				
		Y3	Yellow:596nm				
		Y	Yellow:590nm				
		W	Yellow:585nm				
		Y2	Yellow:580nm				
		M2	Yellowish-Green:576nm				
		M	Yellowish-Green:572nm				
		F	Green:566nm				
		P	Green:560nm				
		E	Bluish green:527nm				
		B	Blue:470nm				
		WB	White				

- Concerning the Brightness rank
- Please refer to the rank chart above for luminous intensity classification.
- Part name is individual for each rank.
- When shipped as sample, the part name will be a representative part name.
- General products are free of ranks. Please contact sales if rank appointment is needed.

●Packing Specification

ROHM LED products are being shipped with desiccant (silica gel) concluded in moisture-proof bags.

Pasting the moisture sensitive label on the outer surface of the moisture-proof bags or enclosing the humidity indication card inside the bag is available upon request.

Please contact the nearest sales office or distributor if necessary.

●Precaution (Surface Mount Device)

1.Storage

If the product is heated during the reflow under the condition of hygroscopic state, it may vaporize and expand which will influence the performance of the product. Therefore, the package is waterproof. Please use the product following the conditions:

• Using Conditions

Classification	Temperature	Humidity	Expiration Date	Remark
① Before using	5 to 30°C	30 to 70%RH	Within 1 year from Receiving	Storage with waterproof package
② After opening package	5 to 30°C	Below 70%RH	Within 168h	Please storing in the airtight container with our desiccant (silica gel)

• Baking

Bake the product in case of below:

- ① The expiration date is passed.
- ② The color of indicator (silica gel) turned from blue to colorless or from green to pink.
(Even if the product is within the expiration date.)

• Baking Conditions

Temperature	Time	Humidity
60±3°C	12 to 24h	Below 20%RH
Remark	<ul style="list-style-type: none"> • Bake products in reel. • Reel and embossed tape are easy to be deformed when baking, so please try not to apply stress on it. • Recommend bake once. 	

2.Application Methods

2-1. Precaution for Drive System and Off Mode

Design the circuit without the electric load exceeding the ABSOLUTE MAXIMUM RATING that applies on the products. If drive by constant voltage, it may cause current deviation of the LED and result in deviation of luminous intensity, so we recommend to drive by constant current. (Deviation of VF Value will cause deviation of current in LED.) Furthermore, for off mode, please do not apply voltage neither forward nor reverse. Especially, for the products with the Ag-paste used in the die bonding, there's high possibility to cause electro migration and result in function failure.

2-2. Operation Life Span

There's possibility for intensity of light drop according to working conditions and environments (applied current, surrounding temperature and humidity, corrosive gases), please call our Sales staffs for inquiries about the concerned application below.

- ① Longtime intensity of light life
- ② On mode all the time

2-3. Applied Stress on Product

The top of the LED is very soft, which the silicon resin is used as sealing resin. Therefore, please pay attention to the overstress on it which may influence its reliability.

2-4. Usage

The Product is LED. We are not responsible for the usage as the diode such as Protection Chip, Rectifier, Switching and so on.

3. Others

3-1. Surrounding Gas

Notice that if it is stored under the condition of acid gas (chlorine gas, sulfured gas) or alkali gas (ammonia), it may result in low soldering ability (caused by the change in quality of the plating surface) or optical characteristics changes (light intensity, chrominance) and change in quality of die bonding (Ag-paste) materials. All of the above will cause function failure of the products.

Therefore, please pay attention to the storage environment for mounted product (concern the generated gas of the surrounding parts of the products and the atmospheric environment).

3-2. Electrostatic Damage

The product is part of semiconductor and electrostatic sensitive, there's high possibility to be damaged by the electrostatic discharge. Please take appropriate measures to avoid the static electricity from human body and earthing of production equipment. The resistance values of electrostatic discharge (actual values) vary with products, therefore, please call our Sales staffs for inquiries.

3-3. Electromagnetic Wave

Please concern the influence on LED in case of application with strong electromagnetic wave such as IH (Induction heating).

4. Mounting

4-1. Soldering

- No resin hardening agent such as filler is used in the sealing resin of the product. Therefore, resin expansion and moisture absorption at humidity will cause heat stress during soldering process and finally has bad influence on the product's reliability.
- The product is not for flow soldering.
- Do not expose the product in the environment of high temperature (over 100°C) or rapid temperature shift (within 3°C of temperature gradient) during the flow soldering of surrounding parts.
- Please set appropriate reflow temperature based on our product usage conditions and specification.
- The max for reflowing is 2 times, please finish the second flow soldering and flow soldering with other parts within the usage limitation after open the moistureproof package.
- Compare with N2 reflow, during air reflow, because of the heat and surrounding conditions, it may cause the discoloration of the resin.
- For our product that has no solder resist, because of its solder amount and soldering conditions, one of its specific characteristics is that solder will penetrate into LED. Thus, there's high possibility that will influence its reliability. Therefore, please be informed, concerning it before using it.

4-2. Automatic Mounting

4-2-1. Silicon Resin Sealing Product

The sealing resin of LED is very soft, so please select adsorption nozzle that would not apply stress directly on the sealing section.

4-2-2. Mini Package (Smaller than 1006 size)

Vibration may result in low mounting rate since it will cause the static electricity of product and adhere to top cover tape. Therefore, the magnet should be set on parts feeder cassette of the mounter to control the product stabilization. In addition, it is recommended to set ionizer to prevent electrostatic charge.

4-3. Mounting Location

The stress like bending stress of circuit board dividing after mounting, may cause LED package crack or damage of LED internal junction, therefore, please concern the mounting direction and position to avoid bending or screwing with great stress of the circuit board.

4-4. Mechanical Stress after Mounting

The mechanical stress may damage the LED after Circuit Mounting, so please pay attention to the touch on product.

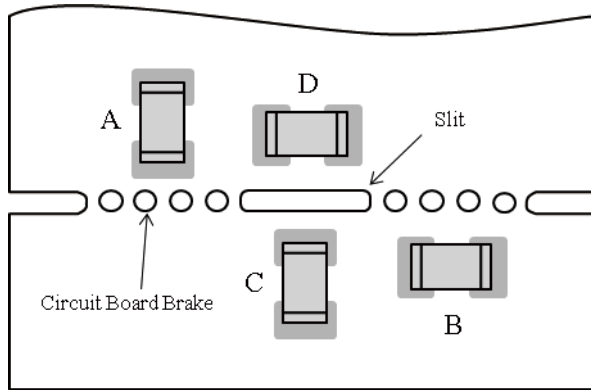

Stress strength according to the mounting position:
A>B>C>D

4-5. Soldering Pattern for Recommendation

We recommend the soldering pattern that shows on the right. It will be different according to mounting situation of circuit board, therefore, please concern before designing.

*The product has adopted the electrode structure that it should solder with back electrode of the product. Thus, please be informed that the shape of electrode pin of solder fillet formation is not guaranteed.

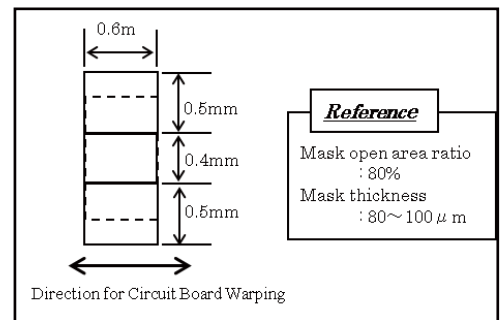

4-6. Reflow Profile

For reflow profile, please refer to the conditions below:(*)

• Meaning of marks, Conditions

Mark	Meanings	Conditions
Ts _{max}	Maximum of pre-heating temperature	180°C
Ts _{min}	Minimum of pre-heating temperature	140°C
Ts	Time from Ts _{min} to Ts _{max}	Over 60sec.
T _L	Reference temperature	230 to 260°C
t _L	Retention time for T _L	Within 40sec.
T _P	Peak temperature	260°C(Max)
t _P	Time for peak temperature	Within 10sec.
ΔT _R /Δt	Temperature rising rate	Under 3°C/sec.
ΔT _D /Δt	Temperature decreasing rate	Over -3°C/sec.

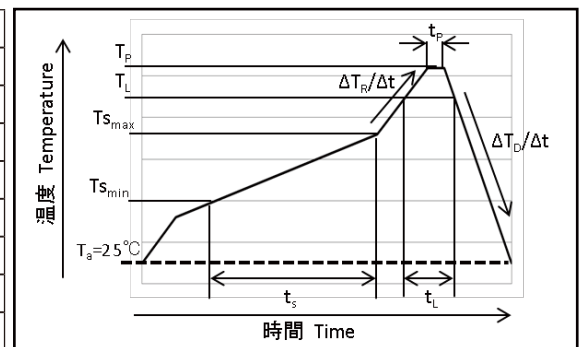

*Above conditions are for reference. Therefore, evaluate by customer's own circuit boards and reflow furnaces before using, because stress from circuit boards and temperature variations of reflow furnaces vary by customer's own conditions.

4-7. Cleaning after Soldering

Please follow the conditions below if the cleaning is necessary after soldering.

Solvent	We recommend to use alcohols solvent such as, isopropyl alcohols
Temperature	Under 30°C within 3 minutes
Ultrasonic Cleaning	15W / Below 1 liter (capacity of tank)
Drying	Under 100°C within 3 minutes

Notes

- 1) The information contained herein is subject to change without notice.
- 2) Before you use our Products, please contact our sales representative and verify the latest specifications :
- 3) Although ROHM is continuously working to improve product reliability and quality, semiconductors can break down and malfunction due to various factors.
Therefore, in order to prevent personal injury or fire arising from failure, please take safety measures such as complying with the derating characteristics, implementing redundant and fire prevention designs, and utilizing backups and fail-safe procedures. ROHM shall have no responsibility for any damages arising out of the use of our Products beyond the rating specified by ROHM.
- 4) Examples of application circuits, circuit constants and any other information contained herein are provided only to illustrate the standard usage and operations of the Products. The peripheral conditions must be taken into account when designing circuits for mass production.
- 5) The technical information specified herein is intended only to show the typical functions of and examples of application circuits for the Products. ROHM does not grant you, explicitly or implicitly, any license to use or exercise intellectual property or other rights held by ROHM or any other parties. ROHM shall have no responsibility whatsoever for any dispute arising out of the use of such technical information.
- 6) The Products are intended for use in general electronic equipment (i.e. AV/OA devices, communication, consumer systems, gaming/entertainment sets) as well as the applications indicated in this document.
- 7) The Products specified in this document are not designed to be radiation tolerant.
- 8) For use of our Products in applications requiring a high degree of reliability (as exemplified below), please contact and consult with a ROHM representative : transportation equipment (i.e. cars, ships, trains), primary communication equipment, traffic lights, fire/crime prevention, safety equipment, medical systems, servers, solar cells, and power transmission systems.
- 9) Do not use our Products in applications requiring extremely high reliability, such as aerospace equipment, nuclear power control systems, and submarine repeaters.
- 10) ROHM shall have no responsibility for any damages or injury arising from non-compliance with the recommended usage conditions and specifications contained herein.
- 11) ROHM has used reasonable care to ensure the accuracy of the information contained in this document. However, ROHM does not warrants that such information is error-free, and ROHM shall have no responsibility for any damages arising from any inaccuracy or misprint of such information.
- 12) Please use the Products in accordance with any applicable environmental laws and regulations, such as the RoHS Directive. For more details, including RoHS compatibility, please contact a ROHM sales office. ROHM shall have no responsibility for any damages or losses resulting non-compliance with any applicable laws or regulations.
- 13) When providing our Products and technologies contained in this document to other countries, you must abide by the procedures and provisions stipulated in all applicable export laws and regulations, including without limitation the US Export Administration Regulations and the Foreign Exchange and Foreign Trade Act.
- 14) This document, in part or in whole, may not be reprinted or reproduced without prior consent of ROHM.



Thank you for your accessing to ROHM product informations.
More detail product informations and catalogs are available, please contact us.

ROHM Customer Support System

<http://www.rohm.com/contact/>