

September 2016



MULTILAYER CERAMIC CAPACITORS



SAMSUNG
ELECTRO-MECHANICS



We declare that all our MLCCs are produced
in accordance with EU RoHS and REACH Directive.



RoHS Compliance and restriction of Br

The following restricted materials are not used in packaging materials as well as products in compliance with the law and restriction.

- Cd, Pb, Hg, Cr6+, As, Br and the compounds, PCB, asbestos

No use of materials breaking Ozone layer

The following ODS materials are not used in our fabrication process.

- ODS material : Freon, Haron, 1 – 1 – 1 TCE, CCl₄, HCFC

If you want more detailed Information, Please Visit Samsung Electro –mechanics Website
<http://www.semlcr.com>

In order to move to the contents directly, please click each content icon

Contents

Part Numbering System	04
Standard & High Capacitors	06
Low Profile Capacitors	34
Super Small Size Capacitors	39
High - Q Capacitors	47
Medium - High Voltage Capacitors	52
Soft - term Capacitors	62
Low Acoustic Noise Capacitors	65
High Effective Capacitance Capacitors	68
Low ESL Capacitors	71
Array Type Capacitors	76
Industrial Capacitors	79
Reliability Test Condition	128
Premium Capacitors for Automotive Applications	132
Packaging Specification	146
Application Manual for Surface Mounting	150
Certifications	154



※ Remarks : Symbols in this catalog have the following definition.

- Derating** This capacitor with derating is designed for 70% of the rated voltage or less.
- dv/dt** dv/dt means Pulse(dv/dt) Guarantee Capacitor, 10,000V/us(=10V/ns) max.10,000 cycles guarantee(@Vr, Room temp)
- Ref.** Reference means that CAP & TCC have the exceptional measurement conditions for Capacitance and Temperature Characteristics of Capacitance.
So please refer to the individual specification for CAP and the individual characteristics data for TCC on Website.

Part Numbering System

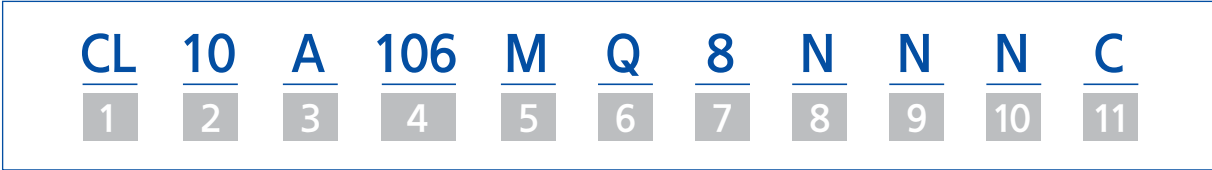

1 SERIES CODE

CL = Multilayer Ceramic Capacitors

2 SIZE CODE

Code	inch(mm)	Code	inch(mm)	Code	inch(mm)	Code	inch(mm)
02	01005(0402)	10	0603(1608)	32	1210(3225)	55	2220(5750)
03	0201(0603)	21	0805(2012)	42	1808(4520)		
05	0402(1005)	31	1206(3216)	43	1812(4532)		

3 DIELECTRIC CODE

Class I (Temperature Compensation)

Symbol	EIA Code	Operation Temperature Range(°C)	Temperature Coefficient(ppm / °C)
C	COG	-55 ~ +125	0±30

Class II (High Dielectric Constant)

Symbol	EIA Code	Operation Temperature Range(°C)	Capacitance Change(%)
A	X5R	-55 ~ +85	±15
B	X7R	-55 ~ +125	±15
X	X6S	-55 ~ +105	±22
F	Y5V	-30 ~ +85	-82 ~ +22
Y	X7S	-55 ~ +125	±22
Z	X7T	-55 ~ +125	-33 ~ +22

4 CAPACITANCE CODE

Capacitance expressed in pF. 2 significant digits plus number of zeros.
example) 106=10×10⁶=10,000,000pF

For Values <10pF, Letter R denotes decimal point
example) 1R5 =1.5pF

5 CAPACITANCE TOLERANCE CODE

Code	Tolerance	Code	Tolerance	Code	Tolerance	Code	Tolerance
N	±0.03pF	H	+0.25pF	F*	±1%	V	-5%
A	±0.05pF	L	-0.25pF	G	±2%	K	±10%
B	±0.1pF	D	±0.5pF	J	±5%	M	±20%
C	±0.25pF	F	±1pF	U	+5%	Z	-20, +80%

* For Values < 10pF, F = ±1pF / Values ≥ 10pF, F = ±1%

Series	Capacitance Step											
E-3	1.0				2.2				4.7			
E-6	1.0		1.5		2.2		3.3		4.7		6.8	
E-12	1.0	1.2	1.5	1.8	2.2	2.7	3.3	3.9	4.7	5.6	6.8	8.2
E-24	1.0	1.2	1.5	1.8	2.2	2.7	3.3	3.9	4.7	5.6	6.8	8.2
	1.1	1.3	1.6	2.0	2.4	3.0	3.6	4.3	5.1	6.2	7.5	9.1

6 RATED VOLTAGE CODE

Code	Voltage	Code	Voltage	Code	Voltage	Code	Voltage
S	2.5Vdc	O	16Vdc	C	100Vdc	H	630Vdc
R	4.0Vdc	A	25Vdc	D	200Vdc	I	1kVdc
Q	6.3Vdc	L	35Vdc	E	250Vdc	J	2kVdc
P	10Vdc	B	50Vdc	G	500Vdc	K	3kVdc

7 THICKNESS CODE

(Unit:mm)

Size inch(mm)	Code	Thickness	Tolerance	Size inch(mm)	Code	Thickness	Tolerance
01005(0402)	2	0.20	±0.02	1210(3225)	C	0.85	±0.10*
0201(0603)	3	0.30	±0.03		9	0.90	±0.10*
0402(1005)	3	0.30	±0.03*		F	1.25	±0.20
	5	0.50	±0.05		S	1.35	±0.15*
0603(1608)	5	0.50	+0.0 / -0.1*		H	1.60	±0.20
	8	0.80	±0.10		U	1.80	±0.20*
0805(2012)	A	0.65	±0.10		I	2.00	±0.20
	C	0.85	±0.10*		J	2.50	±0.20
	C	0.85	±0.10		V	2.50	±0.30
	M	1.15	±0.10		1808(4520)	F	1.25
	F	1.25	±0.10	G		1.40	±0.20
	Q	1.25	±0.15	I		2.00	±0.20
1206(3216)	Y	1.25	±0.20	1812(4532)	F	1.25	±0.20
	C	0.85	±0.15		H	1.60	±0.20
	C	0.85	±0.10*		I	2.00	±0.20
	E	1.10	±0.15		J	2.50	±0.20
	E	1.10	±0.10*	L	3.20	±0.30	
	P	1.15	±0.10*	2220(5750)	H	1.60	±0.20
	M	1.15	±0.15		I	2.00	±0.20
	F	1.25	±0.15		J	2.50	±0.20
	H	1.60	±0.20		L	3.20	±0.30

* Mark is only applicable to "L", "Y", "F", 12th code in part number.

8 INNER ELECTRODE / TERMINATION / PLATING CODE

Code	Thickness division	Inner electrode	Termination	Plating material
N	Normal	Ni	Cu	Ni / Sn _100%
G	Normal	Cu	Cu	Ni / Sn _100%
S	Normal	Ni	Soft Termination	Ni / Sn _100%
C	Normal	Ni	Control Code	Ni / Sn _100%
L	Low profile	Ni	Cu	Ni / Sn _100%
Y	Low profile	Ni	Soft Termination	Ni / Sn _100%
Z	Normal	Ni	Soft Termination	Ni / Sn _100%
F	Low profile	Ni	Soft Termination	Ni / Sn _100%

9 PRODUCT CODE OR SIZE CONTROL CODE

(Unit:mm)

N = Normal
A = Array(2 - element)
B = Array(4 - element)
L = LICC
J = SLIC

Code	01005(0402)	0201(0603)	0402(1005)	0603(1608)	0805(2012)	1206(3216)
S	±0.03	±0.05	±0.07	±0.07		±0.30
Q	±0.05	±0.07	±0.10	±0.15	±0.15	
R	±0.07	±0.09	±0.15	±0.20	±0.20	
U	±0.09		±0.20	±0.25	±0.25	
Z			±0.40	±0.30	±0.30	
9			±0.30			

10 CONTROL CODE

N = Reserved for future use

11 PACKAGING CODE

Cardboard Tape (Paper)		Embossed Tape (Plastic)	
Code	Taping Type	Code	Taping Type
8 / C / H	Normal, 7" reel (Quantity option)	E / G	Normal, 7" reel (Quantity option)
J	1mm Pitch, 7" reel	R	Chip aligned for horizontal, 7" reel
Z	Chip aligned for horizontal, 7" reel	W	Chip aligned for vertical, 7" reel
Y	Chip aligned for vertical, 7" reel	S	Normal, 10" reel
O	Normal, 10" reel	F	Normal, 13" reel (Quantity option)
3 / D / L	Normal, 13" reel (Quantity option)		
2	1mm Pitch, 13" reel		
7	Chip aligned for vertical, 13" reel		

※ If you want to learn the code or quantity in detail, please see p.148
In order to move to the page directly, please click the here. †

Standard & High Capacitors

Feature

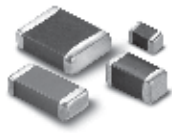

- Wide selection of size : from 0402(Inch) to 2220(Inch)
- Highly reliable tolerance and high speed automatic chip placement on PCBs
- Wide capacitance range
- Highly reliable performance
- Highly resistant termination metal
- Tape & reel for surface mount assembly

Application

- Mobile Phone
- DC-DC Converter
- Tablet devices
- PC (Laptop, Desktop)
- HDD /SSD board
- Display

Structure and Dimensions

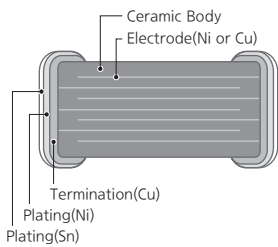
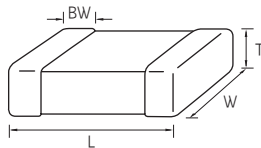

Size Code	EIA Code	Dimension(mm)				
		L	W	T	Thickness Code	BW
05	0402	1.00±0.05	0.50±0.05	0.0975±0.0125(*)	L	0.25±0.075
		1.00±0.10	0.50±0.05	0.19±0.03(*)	X	
		1.00±0.05	0.50±0.05	0.30±0.03(*)	3	
		1.00±0.05	0.50±0.05	0.50±0.05	5	
10	0603	1.60±0.10	0.80±0.10	0.50±0.0/-0.1(*)	5	0.30±0.20
		1.60±0.10	0.80±0.10	0.80±0.10	8	
21	0805	2.00±0.10	1.25±0.10	0.70±0.10(*)	7	0.50±0.20/-0.30
		2.00±0.10	1.25±0.10	0.80±0.10(*)	8	
		2.00±0.10	1.25±0.10	0.85±0.10	C	
		2.00±0.10	1.25±0.10	0.90±0.10(*)	9	
		2.00±0.10	1.25±0.10	1.15±0.10	M	
		2.00±0.10	1.25±0.10	1.25±0.10	F	
		2.00±0.20	1.25±0.20	1.25±0.20	Y	
31	1206	3.20±0.20	1.60±0.20	0.60±0.10(*)	6	0.50±0.30
		3.20±0.15	1.60±0.15	0.85±0.15	C	
		3.20±0.20	1.60±0.20	0.85±0.10(*)	C	
		3.20±0.20	1.60±0.20	0.90±0.10(*)	9	
		3.20±0.20	1.60±0.20	1.10±0.10(*)	E	
		3.20±0.20	1.60±0.20	1.15±0.10(*)	M	
		3.20±0.20	1.60±0.20	1.15±0.10(*)	P	
		3.20±0.15	1.60±0.15	1.25±0.15	F	
3.20±0.20	1.60±0.20	1.60±0.20	H			
32	1210	3.20±0.30	2.50±0.20	0.85±0.10(*)	C	0.60±0.30
		3.20±0.30	2.50±0.20	0.90±0.10(*)	9	
		3.20±0.30	2.50±0.20	1.60±0.20	H	
		3.20±0.30	2.50±0.20	1.80±0.20(*)	U	
		3.20±0.30	2.50±0.20	2.00±0.20	I	
		3.20±0.30	2.50±0.20	2.50±0.20	J	
42	1808	4.50±0.40	2.00±0.20	1.25±0.20	F	0.80±0.30
		4.50±0.40	2.00±0.20	1.40±0.20	G	
		4.50±0.40	2.00±0.20	2.00±0.20	I	
43	1812	4.50±0.40	3.20±0.30	1.25±0.20	F	0.80±0.30
		4.50±0.40	3.20±0.30	2.50±0.20	J	
		4.50±0.40	3.20±0.30	3.20±0.30	L	
55	2220	5.70±0.40	5.00±0.40	2.50±0.20	J	1.00±0.30
		5.70±0.40	5.00±0.40	3.20±0.30	L	

* Mark is only applicable to "L", "F", 12th code in part number.

Standard & High Capacitors

Standard & High Capacitance Table (X5R)

Size inch (mm)	Rated Voltage (Vdc)	Capacitance											
		nF			uF								
		100	220	470	1.0	2.2	4.7	10	22	47	100	220	
0402 (1005)	4.0												
	6.3												
	10												
	16												
	25												
	35												
0603 (1608)	4.0												
	6.3												
	10												
	16												
	25												
	35												
	50												
0805 (2012)	4.0												
	6.3												
	10												
	16												
	25												
	35												
	50												
1206 (3216)	6.3											150	
	10												
	16												
	25												
	35												
	50												
1210 (3225)	6.3												
	10												
	16												
	25												
	35												
	50												
1812(4532)	6.3												
2220(5750)	6.3												
	10												

Standard & High Capacitance Table (X6S)

Size inch (mm)	Rated Voltage (Vdc)	Capacitance										
		nF			uF							
		100	220	470	1.0	2.2	4.7	10	22	47	100	
0402 (1005)	2.5											
	4.0											
	6.3											
	10											
	25											
0603 (1608)	4.0											
	6.3											
	10											
	16											
	25											
0805 (2012)	2.5											
	4.0											
	6.3											
	10											
	16											
	25											
1206 (3216)	4.0											
	6.3											
	10											
	16											
	25											
1210 (3225)	4.0											
	6.3											
	10											
	16											
	25											

Standard & High Capacitors

Standard & High Capacitance Table (X7R)

Size inch (mm)	Rated Voltage (Vdc)	Capacitance												
		nF					uF							
		47	100	220	330	470	1.0	2.2	3.3	4.7	10	22	47	100
0402 (1005)	6.3						X7S							
	10													
	16													
	25													
	50													
0603 (1608)	6.3										X7S			
	10													
	16													
	25													
	50													
0805 (2012)	6.3													
	10													
	16													
	25													
	35													
	50													
1206 (3216)	6.3													
	10													
	16													
	25													
	35													
	50													
1210 (3225)	6.3													X7T
	10													
	16													
	25													
	35													
	50													

Product Line Up (COG)

■ Size : 1.00 X 0.50mm (inch : 0402)

Thickness Max.	Rated Voltage	Capacitance	Capacitance Tolerance	Part Number	Thickness Max.	Rated Voltage	Capacitance	Capacitance Tolerance	Part Number		
0.55mm	10Vdc	560pF	±5%	CL05C561JP5NNN □	0.55mm	50Vdc	2.2pF	±0.1pF	CL05C2R2BB5NNN □		
		16Vdc	33pF	±5%			CL05C330JO5NNN □	2.2pF	±0.25pF	CL05C2R2CB5NNN □	
	100pF		±5%	CL05C101JO5NNN □			2.4pF	±0.1pF	CL05C2R4BB5NNN □		
	150pF		±5%	CL05C151JO5NNN □			2.4pF	±0.25pF	CL05C2R4CB5NNN □		
	220pF		±5%	CL05C221JO5NNN □			2.5pF	±0.1pF	CL05C2R5BB5NNN □		
	470pF		±5%	CL05C471JO5NNN □			2.5pF	±0.25pF	CL05C2R5CB5NNN □		
	1.0nF		±5%	CL05C102JO5NNN □			2.7pF	±0.1pF	CL05C2R7BB5NNN □		
	25Vdc	10pF	±0.5pF	CL05C100DA5NNN □			2.7pF	±0.25pF	CL05C2R7CB5NNN □		
			±5%	CL05C100JA5NNN □			3.0pF	±0.1pF	CL05C030BB5NNN □		
			±5%	CL05C110JA5NNN □			3.0pF	±0.25pF	CL05C030CB5NNN □		
			±5%	CL05C120JA5NNN □			3.3pF	±0.1pF	CL05C3R3BB5NNN □		
			±5%	CL05C130JA5NNN □			3.3pF	±0.25pF	CL05C3R3CB5NNN □		
			±5%	CL05C150JA5NNN □			3.5pF	±0.25pF	CL05C3R5CB5NNN □		
			±2%	CL05C180GA5NNN □			3.6pF	±0.25pF	CL05C3R6CB5NNN □		
			±5%	CL05C200JA5NNN □			3.9pF	±0.1pF	CL05C3R9BB5NNN □		
			±5%	CL05C220JA5NNN □			3.9pF	±0.25pF	CL05C3R9CB5NNN □		
			±2%	CL05C270GA5NNN □			4.0pF	±0.1pF	CL05C040BB5NNN □		
			±5%	CL05C270JA5NNN □			4.0pF	±0.25pF	CL05C040CB5NNN □		
			±5%	CL05C330JA5NNN □			4.3pF	±0.25pF	CL05C4R3CB5NNN □		
			±5%	CL05C390JA5NNN □			4.7pF	±0.1pF	CL05C4R7BB5NNN □		
			±5%	CL05C430JA5NNN □			4.7pF	±0.25pF	CL05C4R7CB5NNN □		
			±5%	CL05C470JA5NNN □			4.7pF	±0.5pF	CL05C4R7DB5NNN □		
			±5%	CL05C680JA5NNN □			5.0pF	±0.1pF	CL05C050BB5NNN □		
			±5%	CL05C820JA5NNN □			5.0pF	±0.25pF	CL05C050CB5NNN □		
			±5%	CL05C910JA5NNN □			5.0pF	±0.5pF	CL05C050DB5NNN □		
			±5%	CL05C101JA5NNN □			5.1pF	±0.25pF	CL05C5R1CB5NNN □		
			±10%	CL05C101KA5NNN □			5.6pF	±0.1pF	CL05C5R6BB5NNN □		
			±5%	CL05C121JA5NNN □			5.6pF	±0.25pF	CL05C5R6CB5NNN □		
			±5%	CL05C151JA5NNN □			5.6pF	±0.5pF	CL05C5R6DB5NNN □		
			±5%	CL05C181JA5NNN □			6.0pF	±0.25pF	CL05C060CB5NNN □		
			±1%	CL05C221FA5NNN □			6.0pF	±0.5pF	CL05C060DB5NNN □		
			±5%	CL05C221JA5NNN □			6.2pF	±0.25pF	CL05C6R2CB5NNN □		
			±5%	CL05C271JA5NNN □			6.2pF	±0.5pF	CL05C6R2DB5NNN □		
			±5%	CL05C561JA5NNN □			6.8pF	±0.1pF	CL05C6R8BB5NNN □		
			±5%	CL05C102JA5NNN □			6.8pF	±0.25pF	CL05C6R8CB5NNN □		
			50Vdc	0.2pF			±0.1pF	CL05C0R2BB5NNN □	6.8pF	±0.5pF	CL05C6R8DB5NNN □
							±0.1pF	CL05C0R3BB5NNN □	7.0pF	±0.1pF	CL05C070BB5NNN □
	±0.25pF	CL05C0R3CB5NNN □					7.0pF	±0.25pF	CL05C070CB5NNN □		
	±0.1pF	CL05C0R5BB5NNN □					7.0pF	±0.5pF	CL05C070DB5NNN □		
	±0.25pF	CL05C0R5CB5NNN □					8.0pF	±0.25pF	CL05C080CB5NNN □		
	±0.1pF	CL05C0R7BB5NNN □					8.0pF	±0.5pF	CL05C080DB5NNN □		
	±0.1pF	CL05CR75BB5NNN □					8.2pF	±0.1pF	CL05C8R2BB5NNN □		
	±0.25pF	CL05CR75CB5NNN □					8.2pF	±0.25pF	CL05C8R2CB5NNN □		
	±0.1pF	CL05C010BB5NNN □					8.2pF	±0.5pF	CL05C8R2DB5NNN □		
	±0.25pF	CL05C010CB5NNN □					9.0pF	±0.25pF	CL05C090CB5NNN □		
	±0.1pF	CL05C1R2BB5NNN □					9.0pF	±0.5pF	CL05C090DB5NNN □		
	±0.25pF	CL05C1R2CB5NNN □					9.1pF	±0.1pF	CL05C9R1BB5NNN □		
	±0.1pF	CL05C1R3BB5NNN □					9.1pF	±0.25pF	CL05C9R1CB5NNN □		
	±0.1pF	CL05C1R5BB5NNN □					10pF	±0.25pF	CL05C100CB5NNN □		
	±0.25pF	CL05C1R5CB5NNN □					10pF	±0.5pF	CL05C100DB5NNN □		
	±0.1pF	CL05C1R8BB5NNN □					10pF	±5%	CL05C100JB5NNN □		
	±0.25pF	CL05C1R8CB5NNN □					11pF	±5%	CL05C110JB5NNN □		
	±0.1pF	CL05C020BB5NNN □					12pF	±2%	CL05C120GB5NNN □		
	±0.25pF	CL05C020CB5NNN □					12pF	±5%	CL05C120JB5NNN □		

※ □ mark means packaging code. If you want to learn the code or quantity in detail, please see p.148
In order to move to the page directly, please click the here. ↑

Standard & High Capacitors

Product Line Up (COG)

■ Size : 1.00 X 0.50mm (inch : 0402)

Thickness Max.	Rated Voltage	Capacitance	Capacitance Tolerance	Part Number
0.55mm	50Vdc	13pF	±5%	CL05C130JB5NNN□
		14pF	±5%	CL05C140JB5NNN□
		15pF	±5%	CL05C150JB5NNN□
		16pF	±5%	CL05C160JB5NNN□
		17pF	±5%	CL05C170JB5NNN□
		18pF	±2%	CL05C180GB5NNN□
		18pF	±5%	CL05C180JB5NNN□
		20pF	±2%	CL05C200GB5NNN□
		20pF	±5%	CL05C200JB5NNN□
		22pF	±1%	CL05C220FB5NNN□
		22pF	±2%	CL05C220GB5NNN□
		22pF	±5%	CL05C220JB5NNN□
		24pF	±5%	CL05C240JB5NNN□
		26pF	±5%	CL05C260JB5NNN□
		27pF	±1%	CL05C270FB5NNN□
		27pF	±5%	CL05C270JB5NNN□
		30pF	±5%	CL05C300JB5NNN□
		33pF	±1%	CL05C330FB5NNN□
		33pF	±5%	CL05C330JB5NNN□
		36pF	±5%	CL05C360JB5NNN□
		39pF	±2%	CL05C390GB5NNN□
		39pF	±5%	CL05C390JB5NNN□
		43pF	±2%	CL05C430GB5NNN□
		43pF	±5%	CL05C430JB5NNN□
		47pF	±1%	CL05C470FB5NNN□
		47pF	±5%	CL05C470JB5NNN□
		51pF	±5%	CL05C510JB5NNN□
		56pF	±1%	CL05C560FB5NNN□
		56pF	±5%	CL05C560JB5NNN□
		62pF	±2%	CL05C620GB5NNN□
		62pF	±5%	CL05C620JB5NNN□
		68pF	±5%	CL05C680JB5NNN□
		75pF	±5%	CL05C750JB5NNN□
82pF	±5%	CL05C820JB5NNN□		
91pF	±5%	CL05C910JB5NNN□		
100pF	±1%	CL05C101FB5NNN□		
100pF	±2%	CL05C101GB5NNN□		
100pF	±5%	CL05C101JB5NNN□		
100pF	±10%	CL05C101KB5NNN□		
110pF	±5%	CL05C111JB5NNN□		
120pF	±2%	CL05C121GB5NNN□		
120pF	±5%	CL05C121JB5NNN□		
130pF	±5%	CL05C131JB5NNN□		
150pF	±5%	CL05C151JB5NNN□		
160pF	±5%	CL05C161JB5NNN□		
180pF	±5%	CL05C181JB5NNN□		
200pF	±5%	CL05C201JB5NNN□		
220pF	±1%	CL05C221FB5NNN□		
220pF	±2%	CL05C221GB5NNN□		
220pF	±5%	CL05C221JB5NNN□		
240pF	±5%	CL05C241JB5NNN□		
270pF	±5%	CL05C271JB5NNN□		
300pF	±5%	CL05C301JB5NNN□		
330pF	±5%	CL05C331JB5NNN□		

Thickness Max.	Rated Voltage	Capacitance	Capacitance Tolerance	Part Number
0.55mm	50Vdc	390pF	±5%	CL05C391JB5NNN□
		470pF	±1%	CL05C471FB5NNN□
		470pF	±5%	CL05C471JB5NNN□
		560pF	±5%	CL05C561JB5NNN□
		680pF	±5%	CL05C681JB5NNN□
		820pF	±5%	CL05C821JB5NNN□
		1.0nF	±1%	CL05C102FB5NNN□
		1.0nF	±5%	CL05C102JB5NNN□

■ Size : 1.60 X 0.80mm (inch : 0603)

Thickness Max.	Rated Voltage	Capacitance	Capacitance Tolerance	Part Number	
0.90mm	16Vdc	68pF	±1%	CL10C680F08NNN□	
		68pF	±2%	CL10C680G08NNN□	
		100pF	±2%	CL10C101G08NNN□	
		820pF	±5%	CL10C821J08NNN□	
		1.0nF	±5%	CL10C102J08NNN□	
		2.2nF	±5%	CL10C222J08NNN□	
		3.9nF	±5%	CL10C392J08NNN□	
		25Vdc	10pF	±0.5pF	CL10C100DA8NNN□
			10pF	±5%	CL10C100JA8NNN□
			15pF	±5%	CL10C150JA8NNN□
			20pF	±5%	CL10C200JA8NNN□
			33pF	±5%	CL10C330JA8NNN□
			47pF	±5%	CL10C470JA8NNN□
			68pF	±5%	CL10C680JA8NNN□
			100pF	±5%	CL10C101JA8NNN□
	100pF		±10%	CL10C101KA8NNN□	
	120pF		±5%	CL10C121JA8NNN□	
	150pF		±5%	CL10C151JA8NNN□	
	180pF		±5%	CL10C181JA8NNN□	
	270pF		±10%	CL10C271KA8NNN□	
	330pF		±10%	CL10C331KA8NNN□	
	390pF		±5%	CL10C391JA8NNN□	
	470pF		±5%	CL10C471JA8NNN□	
	560pF		±5%	CL10C561JA8NNN□	
	680pF		±5%	CL10C681JA8NNN□	
	820pF	±5%	CL10C821JA8NNN□		
	1.5nF	±2%	CL10C152GA8NNN□		
	1.5nF	±5%	CL10C152JA8NNN□		
	1.8nF	±5%	CL10C182JA8NNN□		
	10nF	±5%	CL10C103JA8NNN□		
	1.0nF	±2%	CL10C102GA8NNN□		
	1.0nF	±5%	CL10C102JA8NNN□		
	2.2nF	±2%	CL10C222GA8NNN□		
2.2nF	±5%	CL10C222JA8NNN□			
3.3nF	±2%	CL10C332GA8NNN□			
3.3nF	±5%	CL10C332JA8NNN□			
3.9nF	±5%	CL10C392JA8NNN□			
50Vdc	0.2pF	±0.1pF	CL10C0R2BB8NNN□		
	0.2pF	±0.25pF	CL10C0R2CB8NNN□		
	0.3pF	±0.1pF	CL10C0R3BB8NNN□		
	0.3pF	±0.25pF	CL10C0R3CB8NNN□		

* □ mark means packaging code. If you want to learn the code or quantity in detail, please see p.148

In order to move to the page directly, please click the here. ↑

Product Line Up (COG)

■ Size : 1.60 X 0.80mm (inch : 0603)

Thickness Max.	Rated Voltage	Capacitance	Capacitance Tolerance	Part Number	Thickness Max.	Rated Voltage	Capacitance	Capacitance Tolerance	Part Number
0.90mm	50Vdc	0.47pF	±0.1pF	CL10CR47BB8NNN□	0.90mm	50Vdc	6.8pF	±0.25pF	CL10C6R8CB8NNN□
		0.5pF	±0.1pF	CL10C0R5BB8NNN□			6.8pF	±0.5pF	CL10C6R8DB8NNN□
		0.5pF	±0.25pF	CL10C0R5CB8NNN□			7.0pF	±0.1pF	CL10C070BB8NNN□
		0.56pF	±0.1pF	CL10CR56BB8NNN□			7.0pF	±0.25pF	CL10C070CB8NNN□
		0.68pF	±0.1pF	CL10CR68BB8NNN□			7.0pF	±0.5pF	CL10C070DB8NNN□
		0.75pF	±0.1pF	CL10CR75BB8NNN□			7.5pF	±0.1pF	CL10C7R5BB8NNN□
		0.75pF	±0.25pF	CL10CR75CB8NNN□			7.5pF	±0.25pF	CL10C7R5CB8NNN□
		0.8pF	±0.1pF	CL10C0R8BB8NNN□			7.5pF	±0.5pF	CL10C7R5DB8NNN□
		0.82pF	±0.1pF	CL10CR82BB8NNN□			8.0pF	±0.25pF	CL10C080CB8NNN□
		1.0pF	±0.1pF	CL10C010BB8NNN□			8.0pF	±0.5pF	CL10C080DB8NNN□
		1.0pF	±0.25pF	CL10C010CB8NNN□			8.2pF	±0.1pF	CL10C8R2BB8NNN□
		1.2pF	±0.1pF	CL10C1R2BB8NNN□			8.2pF	±0.25pF	CL10C8R2CB8NNN□
		1.2pF	±0.25pF	CL10C1R2CB8NNN□			8.2pF	±0.5pF	CL10C8R2DB8NNN□
		1.5pF	±0.1pF	CL10C1R5BB8NNN□			9.0pF	±0.25pF	CL10C090CB8NNN□
		1.5pF	±0.25pF	CL10C1R5CB8NNN□			9.0pF	±0.5pF	CL10C090DB8NNN□
		1.8pF	±0.1pF	CL10C1R8BB8NNN□			9.1pF	±0.25pF	CL10C9R1CB8NNN□
		1.8pF	±0.25pF	CL10C1R8CB8NNN□			9.1pF	±0.5pF	CL10C9R1DB8NNN□
		2.0pF	±0.1pF	CL10C020BB8NNN□			10pF	±0.1pF	CL10C100BB8NNN□
		2.0pF	±0.25pF	CL10C020CB8NNN□			10pF	±0.25pF	CL10C100CB8NNN□
		2.2pF	±0.1pF	CL10C2R2BB8NNN□			10pF	±0.5pF	CL10C100DB8NNN□
		2.2pF	±0.25pF	CL10C2R2CB8NNN□			10pF	±1%	CL10C100FB8NNN□
		2.4pF	±0.1pF	CL10C2R4BB8NNN□			10pF	±2%	CL10C100GB8NNN□
		2.4pF	±0.25pF	CL10C2R4CB8NNN□			10pF	±5%	CL10C100JB8NNN□
		2.5pF	±0.1pF	CL10C2R5BB8NNN□			10pF	±10%	CL10C100KB8NNN□
		2.5pF	±0.25pF	CL10C2R5CB8NNN□			11pF	±2%	CL10C110GB8NNN□
		2.7pF	±0.1pF	CL10C2R7BB8NNN□			11pF	±5%	CL10C110JB8NNN□
		2.7pF	±0.25pF	CL10C2R7CB8NNN□			12pF	±1%	CL10C120FB8NNN□
		3.0pF	±0.1pF	CL10C030BB8NNN□			12pF	±2%	CL10C120GB8NNN□
		3.0pF	±0.25pF	CL10C030CB8NNN□			12pF	±5%	CL10C120JB8NNN□
		3.3pF	±0.1pF	CL10C3R3BB8NNN□			13pF	±2%	CL10C130GB8NNN□
		3.3pF	±0.25pF	CL10C3R3CB8NNN□			13pF	±5%	CL10C130JB8NNN□
		3.5pF	±0.25pF	CL10C3R5CB8NNN□			14pF	±5%	CL10C140JB8NNN□
		3.6pF	±0.1pF	CL10C3R6BB8NNN□			15pF	±1%	CL10C150FB8NNN□
		3.6pF	±0.25pF	CL10C3R6CB8NNN□			15pF	±2%	CL10C150GB8NNN□
		3.9pF	±0.1pF	CL10C3R9BB8NNN□			15pF	±5%	CL10C150JB8NNN□
		3.9pF	±0.25pF	CL10C3R9CB8NNN□			15pF	±10%	CL10C150KB8NNN□
		4.0pF	±0.1pF	CL10C040BB8NNN□			16pF	±5%	CL10C160JB8NNN□
		4.0pF	±0.25pF	CL10C040CB8NNN□			17pF	±5%	CL10C170JB8NNN□
		4.3pF	±0.1pF	CL10C4R3BB8NNN□			18pF	±1%	CL10C180FB8NNN□
		4.3pF	±0.25pF	CL10C4R3CB8NNN□			18pF	±2%	CL10C180GB8NNN□
4.7pF	±0.1pF	CL10C4R7BB8NNN□	18pF	±5%	CL10C180JB8NNN□				
4.7pF	±0.25pF	CL10C4R7CB8NNN□	19pF	±5%	CL10C190JB8NNN□				
5.0pF	±0.1pF	CL10C050BB8NNN□	20pF	±1%	CL10C200FB8NNN□				
5.0pF	±0.25pF	CL10C050CB8NNN□	20pF	±2%	CL10C200GB8NNN□				
5.0pF	±0.5pF	CL10C050DB8NNN□	20pF	±5%	CL10C200JB8NNN□				
5.1pF	±0.25pF	CL10C5R1CB8NNN□	21pF	±5%	CL10C210JB8NNN□				
5.6pF	±0.1pF	CL10C5R6BB8NNN□	22pF	±1%	CL10C220FB8NNN□				
5.6pF	±0.25pF	CL10C5R6CB8NNN□	22pF	±2%	CL10C220GB8NNN□				
5.6pF	±0.5pF	CL10C5R6DB8NNN□	22pF	±5%	CL10C220JB8NNN□				
6.0pF	±0.25pF	CL10C060CB8NNN□	22pF	±10%	CL10C220KB8NNN□				
6.0pF	±0.5pF	CL10C060DB8NNN□	23pF	±5%	CL10C230JB8NNN□				
6.2pF	±0.25pF	CL10C6R2CB8NNN□	24pF	±2%	CL10C240GB8NNN□				
6.2pF	±0.5pF	CL10C6R2DB8NNN□	24pF	±5%	CL10C240JB8NNN□				
6.8pF	±0.1pF	CL10C6R8BB8NNN□	25pF	±5%	CL10C250JB8NNN□				

※ □ mark means packaging code. If you want to learn the code or quantity in detail, please see p.148
In order to move to the page directly, please click the here. ↑

Standard & High Capacitors

Product Line Up (COG)

■ Size : 1.60 X 0.80mm (inch : 0603)

Thickness Max.	Rated Voltage	Capacitance	Capacitance Tolerance	Part Number	Thickness Max.	Rated Voltage	Capacitance	Capacitance Tolerance	Part Number
0.90mm	50Vdc	26pF	±5%	CL10C260JB8NNN□	0.90mm	50Vdc	91pF	±5%	CL10C910JB8NNN□
		27pF	±1%	CL10C270FB8NNN□			95pF	±5%	CL10C950JB8NNN□
		27pF	±2%	CL10C270GB8NNN□			100pF	±1%	CL10C101FB8NNN□
		27pF	±5%	CL10C270JB8NNN□			100pF	±2%	CL10C101GB8NNN□
		28pF	±2%	CL10C280GB8NNN□			100pF	±5%	CL10C101JB8NNN□
		28pF	±5%	CL10C280JB8NNN□			100pF	±10%	CL10C101KB8NNN□
		30pF	±1%	CL10C300FB8NNN□			110pF	±5%	CL10C111JB8NNN□
		30pF	±5%	CL10C300JB8NNN□			120pF	±1%	CL10C121FB8NNN□
		32pF	±2%	CL10C320GB8NNN□			120pF	±2%	CL10C121GB8NNN□
		32pF	±5%	CL10C320JB8NNN□			120pF	±5%	CL10C121JB8NNN□
		33pF	±1%	CL10C330FB8NNN□			120pF	±10%	CL10C121KB8NNN□
		33pF	±2%	CL10C330GB8NNN□			130pF	±1%	CL10C131FB8NNN□
		33pF	±5%	CL10C330JB8NNN□			130pF	±5%	CL10C131JB8NNN□
		33pF	±10%	CL10C330KB8NNN□			140pF	±5%	CL10C141JB8NNN□
		35pF	±2%	CL10C350GB8NNN□			150pF	±2%	CL10C151GB8NNN□
		35pF	±5%	CL10C350JB8NNN□			150pF	±5%	CL10C151JB8NNN□
		36pF	±2%	CL10C360GB8NNN□			160pF	±5%	CL10C161JB8NNN□
		36pF	±5%	CL10C360JB8NNN□			170pF	±2%	CL10C171GB8NNN□
		39pF	±1%	CL10C390FB8NNN□			170pF	±5%	CL10C171JB8NNN□
		39pF	±2%	CL10C390GB8NNN□			180pF	±1%	CL10C181FB8NNN□
		39pF	±5%	CL10C390JB8NNN□			180pF	±2%	CL10C181GB8NNN□
		41pF	±2%	CL10C410GB8NNN□			180pF	±5%	CL10C181JB8NNN□
		41pF	±5%	CL10C410JB8NNN□			190pF	±5%	CL10C191JB8NNN□
		42pF	±5%	CL10C420JB8NNN□			200pF	±1%	CL10C201FB8NNN□
		43pF	±5%	CL10C430JB8NNN□			200pF	±5%	CL10C201JB8NNN□
		47pF	±1%	CL10C470FB8NNN□			220pF	±1%	CL10C221FB8NNN□
		47pF	±2%	CL10C470GB8NNN□			220pF	±2%	CL10C221GB8NNN□
		47pF	±5%	CL10C470JB8NNN□			220pF	±5%	CL10C221JB8NNN□
		47pF	±10%	CL10C470KB8NNN□			220pF	±10%	CL10C221KB8NNN□
		50pF	±5%	CL10C500JB8NNN□			240pF	±5%	CL10C241JB8NNN□
		51pF	±2%	CL10C510GB8NNN□			250pF	±5%	CL10C251JB8NNN□
		51pF	±5%	CL10C510JB8NNN□			270pF	±1%	CL10C271FB8NNN□
		56pF	±1%	CL10C560FB8NNN□			270pF	±2%	CL10C271GB8NNN□
		56pF	±2%	CL10C560GB8NNN□			270pF	±5%	CL10C271JB8NNN□
		56pF	±5%	CL10C560JB8NNN□			280pF	±5%	CL10C281JB8NNN□
		56pF	±10%	CL10C560KB8NNN□			300pF	±5%	CL10C301JB8NNN□
		60pF	±5%	CL10C600JB8NNN□			330pF	±0.25pF	CL10C331CB8NNN□
		62pF	±2%	CL10C620GB8NNN□			330pF	±1%	CL10C331FB8NNN□
		62pF	±5%	CL10C620JB8NNN□			330pF	±2%	CL10C331GB8NNN□
		68pF	±1%	CL10C680FB8NNN□			330pF	±5%	CL10C331JB8NNN□
		68pF	±2%	CL10C680GB8NNN□			350pF	±5%	CL10C351JB8NNN□
		68pF	±5%	CL10C680JB8NNN□			360pF	±5%	CL10C361JB8NNN□
68pF	±10%	CL10C680KB8NNN□	390pF	±1%	CL10C391FB8NNN□				
70pF	±2%	CL10C700GB8NNN□	390pF	±2%	CL10C391GB8NNN□				
70pF	±5%	CL10C700JB8NNN□	390pF	±5%	CL10C391JB8NNN□				
75pF	±2%	CL10C750GB8NNN□	390pF	±10%	CL10C391KB8NNN□				
75pF	±5%	CL10C750JB8NNN□	430pF	±5%	CL10C431JB8NNN□				
80pF	±2%	CL10C800GB8NNN□	470pF	±1%	CL10C471FB8NNN□				
80pF	±5%	CL10C800JB8NNN□	470pF	±2%	CL10C471GB8NNN□				
82pF	±1%	CL10C820FB8NNN□	470pF	±5%	CL10C471JB8NNN□				
82pF	±2%	CL10C820GB8NNN□	470pF	±10%	CL10C471KB8NNN□				
82pF	±5%	CL10C820JB8NNN□	500pF	±5%	CL10C501JB8NNN□				
90pF	±5%	CL10C900JB8NNN□	510pF	±5%	CL10C511JB8NNN□				
91pF	±2%	CL10C910JB8NNN□	560pF	±1%	CL10C561FB8NNN□				

※ □ mark means packaging code. If you want to learn the code or quantity in detail, please see p.148

In order to move to the page directly, please click the here. ↑

Product Line Up (COG)

■ Size : 1.60 X 0.80mm (inch : 0603)

Thickness Max.	Rated Voltage	Capacitance	Capacitance Tolerance	Part Number
0.90mm	50Vdc	560pF	±2%	CL10C561GB8NNN □
		560pF	±5%	CL10C561JB8NNN □
		560pF	±10%	CL10C561KB8NNN □
		620pF	±5%	CL10C621JB8NNN □
		680pF	±1%	CL10C681FB8NNN □
		680pF	±2%	CL10C681GB8NNN □
		680pF	±5%	CL10C681JB8NNN □
		680pF	±10%	CL10C681KB8NNN □
		720pF	±5%	CL10C721JB8NNN □
		750pF	±5%	CL10C751JB8NNN □
		820pF	±1%	CL10C821FB8NNN □
		820pF	±2%	CL10C821GB8NNN □
		820pF	±5%	CL10C821JB8NNN □
		820pF	±10%	CL10C821KB8NNN □
		910pF	±5%	CL10C911JB8NNN □
		1.0nF	±1%	CL10C102FB8NNN □
		1.0nF	±2%	CL10C102GB8NNN □
		1.0nF	±5%	CL10C102JB8NNN □
		1.2nF	±5%	CL10C122JB8NNN □
		1.5nF	±5%	CL10C152JB8NNN □
1.8nF	±5%	CL10C182JB8NNN □		
2.2nF	±5%	CL10C222JB8NNN □		
2.7nF	±5%	CL10C272JB8NNN □		
3.3nF	±5%	CL10C332JB8NNN □		
4.7nF	±5%	CL10C472JB8NNN □		
5.6nF	±5%	CL10C562JB8NNN □		

■ Size : 2.00 X 1.25mm (inch : 0805)

Thickness Max.	Rated Voltage	Capacitance	Capacitance Tolerance	Part Number	
0.75mm	25Vdc	220pF	±2%	CL21C221GAANNN □	
		220pF	±5%	CL21C221JAANNN □	
		270pF	±5%	CL21C271JAANNN □	
		680pF	±5%	CL21C681JAANNN □	
		1.5nF	±5%	CL21C152JAANNN □	
		3.9nF	±5%	CL21C392JAANNN □	
		50Vdc	0.47pF	±0.1pF	CL21CR47BBANNN □
			0.47pF	±0.25pF	CL21CR47CBANNN □
			0.5pF	±0.1pF	CL21C0R5BBANNN □
			0.5pF	±0.25pF	CL21C0R5CBANNN □
	0.68pF		±0.1pF	CL21CR68BBANNN □	
	0.75pF		±0.1pF	CL21CR75BBANNN □	
	0.82pF		±0.1pF	CL21CR82BBANNN □	
	0.82pF		±0.25pF	CL21CR82CBANNN □	
	1.0pF		±0.1pF	CL21C010BBANNN □	
	1.0pF		±0.25pF	CL21C010CBANNN □	
	1.2pF	±0.1pF	CL21C1R2BBANNN □		
	1.2pF	±0.25pF	CL21C1R2CBANNN □		
	1.5pF	±0.1pF	CL21C1R5BBANNN □		
	1.5pF	±0.25pF	CL21C1R5CBANNN □		
1.8pF	±0.1pF	CL21C1R8BBANNN □			
1.8pF	±0.25pF	CL21C1R8CBANNN □			
1.8pF	±0.5pF	CL21C1R8DBANNN □			

Thickness Max.	Rated Voltage	Capacitance	Capacitance Tolerance	Part Number
0.75mm	50Vdc	2.0pF	±0.25pF	CL21C020CBANNN □
		2.2pF	±0.1pF	CL21C2R2BBANNN □
		2.2pF	±0.25pF	CL21C2R2CBANNN □
		2.4pF	±0.25pF	CL21C2R4CBANNN □
		2.5pF	±0.25pF	CL21C2R5CBANNN □
		2.7pF	±0.1pF	CL21C2R7BBANNN □
		2.7pF	±0.25pF	CL21C2R7CBANNN □
		3.0pF	±0.1pF	CL21C030BBANNN □
		3.0pF	±0.25pF	CL21C030CBANNN □
		3.2pF	±0.25pF	CL21C3R2CBANNN □
		3.3pF	±0.1pF	CL21C3R3BBANNN □
		3.3pF	±0.25pF	CL21C3R3CBANNN □
		3.6pF	±0.1pF	CL21C3R6BBANNN □
		3.6pF	±0.25pF	CL21C3R6CBANNN □
		3.9pF	±0.1pF	CL21C3R9BBANNN □
		3.9pF	±0.25pF	CL21C3R9CBANNN □
		4.0pF	±0.1pF	CL21C040BBANNN □
		4.0pF	±0.25pF	CL21C040CBANNN □
		4.7pF	±0.1pF	CL21C4R7BBANNN □
		4.7pF	±0.25pF	CL21C4R7CBANNN □
		5.0pF	±0.1pF	CL21C050BBANNN □
		5.0pF	±0.25pF	CL21C050CBANNN □
		5.1pF	±0.25pF	CL21C5R1CBANNN □
		5.6pF	±0.25pF	CL21C5R6CBANNN □
		5.6pF	±0.5pF	CL21C5R6DBANNN □
		6.0pF	±0.25pF	CL21C060CBANNN □
		6.0pF	±0.5pF	CL21C060DBANNN □
		6.2pF	±0.25pF	CL21C6R2CBANNN □
		6.8pF	±0.25pF	CL21C6R8CBANNN □
		6.8pF	±0.5pF	CL21C6R8DBANNN □
7.0pF	±0.25pF	CL21C070CBANNN □		
7.0pF	±0.5pF	CL21C070DBANNN □		
7.5pF	±0.25pF	CL21C7R5CBANNN □		
7.5pF	±0.5pF	CL21C7R5DBANNN □		
8.0pF	±0.25pF	CL21C080CBANNN □		
8.0pF	±0.5pF	CL21C080DBANNN □		
8.2pF	±0.1pF	CL21C8R2BBANNN □		
8.2pF	±0.25pF	CL21C8R2CBANNN □		
8.2pF	±0.5pF	CL21C8R2DBANNN □		
9.0pF	±0.25pF	CL21C090CBANNN □		
9.0pF	±0.5pF	CL21C090DBANNN □		
10pF	±0.1pF	CL21C100BBANNN □		
10pF	±0.25pF	CL21C100CBANNN □		
10pF	±0.5pF	CL21C100DBANNN □		
10pF	±1%	CL21C100FBANNN □		
10pF	±2%	CL21C100GBANNN □		
10pF	±5%	CL21C100JBANNN □		
12pF	±1%	CL21C120FBANNN □		
12pF	±2%	CL21C120GBANNN □		
12pF	±5%	CL21C120JBANNN □		
13pF	±5%	CL21C130JBANNN □		
14pF	±5%	CL21C140JBANNN □		
15pF	±2%	CL21C150GBANNN □		
15pF	±5%	CL21C150JBANNN □		

※ □ mark means packaging code. If you want to learn the code or quantity in detail, please see p.148
In order to move to the page directly, please click the here. ↑

Standard & High Capacitors

Product Line Up (COG)

■ Size : 2.00 X 1.25mm (inch : 0805)

Thickness Max.	Rated Voltage	Capacitance	Capacitance Tolerance	Part Number	Thickness Max.	Rated Voltage	Capacitance	Capacitance Tolerance	Part Number
0.75mm	50Vdc	15pF	±10%	CL21C150KBANNN□	0.75mm	50Vdc	75pF	±5%	CL21C750JBANNN□
		16pF	±5%	CL21C160JBANNN□			80pF	±2%	CL21C800GBANNN□
		17pF	±5%	CL21C170JBANNN□			80pF	±5%	CL21C800JBANNN□
		18pF	±1%	CL21C180FBANNN□			82pF	±1%	CL21C820FBANNN□
		18pF	±2%	CL21C180GBANNN□			82pF	±2%	CL21C820GBANNN□
		18pF	±5%	CL21C180JBANNN□			82pF	±5%	CL21C820JBANNN□
		20pF	±2%	CL21C200GBANNN□			90pF	±5%	CL21C900JBANNN□
		20pF	±5%	CL21C200JBANNN□			91pF	±5%	CL21C910JBANNN□
		22pF	±1%	CL21C220FBANNN□			100pF	±1%	CL21C101FBANNN□
		22pF	±2%	CL21C220GBANNN□			100pF	±2%	CL21C101GBANNN□
		22pF	±5%	CL21C220JBANNN□			100pF	±5%	CL21C101JBANNN□
		22pF	±10%	CL21C220KBANNN□			100pF	±10%	CL21C101KBANNN□
		23pF	±5%	CL21C230JBANNN□			110pF	±5%	CL21C111JBANNN□
		24pF	±2%	CL21C240GBANNN□			120pF	±1%	CL21C121FBANNN□
		24pF	±5%	CL21C240JBANNN□			120pF	±2%	CL21C121GBANNN□
		25pF	±5%	CL21C250JBANNN□			120pF	±5%	CL21C121JBANNN□
		27pF	±1%	CL21C270FBANNN□			130pF	±5%	CL21C131JBANNN□
		27pF	±2%	CL21C270GBANNN□			150pF	±1%	CL21C151FBANNN□
		27pF	±5%	CL21C270JBANNN□			150pF	±2%	CL21C151GBANNN□
		28pF	±5%	CL21C280JBANNN□			150pF	±5%	CL21C151JBANNN□
		30pF	±5%	CL21C300JBANNN□			160pF	±5%	CL21C161JBANNN□
		32pF	±2%	CL21C320GBANNN□			180pF	±1%	CL21C181FBANNN□
		32pF	±5%	CL21C320JBANNN□			180pF	±2%	CL21C181GBANNN□
		33pF	±1%	CL21C330FBANNN□			180pF	±5%	CL21C181JBANNN□
		33pF	±2%	CL21C330GBANNN□			200pF	±5%	CL21C201JBANNN□
		33pF	±5%	CL21C330JBANNN□			220pF	±1%	CL21C221FBANNN□
		33pF	±10%	CL21C330KBANNN□			220pF	±2%	CL21C221GBANNN□
		36pF	±5%	CL21C360JBANNN□			220pF	±5%	CL21C221JBANNN□
		38pF	±2%	CL21C380GBANNN□			220pF	±10%	CL21C221KBANNN□
		38pF	±5%	CL21C380JBANNN□			240pF	±5%	CL21C241JBANNN□
		39pF	±2%	CL21C390GBANNN□			250pF	±5%	CL21C251JBANNN□
		39pF	±5%	CL21C390JBANNN□			260pF	±5%	CL21C261JBANNN□
		40pF	±2%	CL21C400GBANNN□			270pF	±1%	CL21C271FBANNN□
		40pF	±5%	CL21C400JBANNN□			270pF	±2%	CL21C271GBANNN□
		43pF	±5%	CL21C430JBANNN□			270pF	±5%	CL21C271JBANNN□
		47pF	±1%	CL21C470FBANNN□			300pF	±5%	CL21C301JBANNN□
		47pF	±2%	CL21C470GBANNN□			330pF	±1%	CL21C331FBANNN□
		47pF	±5%	CL21C470JBANNN□			330pF	±2%	CL21C331GBANNN□
		47pF	±10%	CL21C470KBANNN□			330pF	±5%	CL21C331JBANNN□
		50pF	±5%	CL21C500JBANNN□			360pF	±5%	CL21C361JBANNN□
		51pF	±2%	CL21C510GBANNN□			390pF	±1%	CL21C391FBANNN□
		51pF	±5%	CL21C510JBANNN□			390pF	±2%	CL21C391GBANNN□
		56pF	±1%	CL21C560FBANNN□			390pF	±5%	CL21C391JBANNN□
		56pF	±2%	CL21C560GBANNN□			430pF	±5%	CL21C431JBANNN□
		56pF	±5%	CL21C560JBANNN□			470pF	±1%	CL21C471FBANNN□
60pF	±5%	CL21C600JBANNN□	470pF	±2%	CL21C471GBANNN□				
62pF	±5%	CL21C620JBANNN□	470pF	±5%	CL21C471JBANNN□				
68pF	±1%	CL21C680FBANNN□	470pF	±10%	CL21C471KBANNN□				
68pF	±2%	CL21C680GBANNN□	510pF	±5%	CL21C511JBANNN□				
68pF	±5%	CL21C680JBANNN□	560pF	±1%	CL21C561FBANNN□				
68pF	±10%	CL21C680KBANNN□	560pF	±2%	CL21C561GBANNN□				
70pF	±5%	CL21C700JBANNN□	560pF	±5%	CL21C561JBANNN□				
70pF	±10%	CL21C700KBANNN□	680pF	±5%	CL21C681JBANNN□				
75pF	±2%	CL21C750GBANNN□	5.0pF	±0.25pF	CL21C050CBCNN□				

※ □ mark means packaging code. If you want to learn the code or quantity in detail, please see p.148
 In order to move to the page directly, please click the here. ↑

Product Line Up (COG)

■ Size : 2.00 X 1.25mm (inch : 0805)

Thickness Max.	Rated Voltage	Capacitance	Capacitance Tolerance	Part Number	Thickness Max.	Rated Voltage	Capacitance	Capacitance Tolerance	Part Number		
0.95mm	50Vdc	10pF	±0.1pF	CL21C100BCCNNN □	0.95mm	50Vdc	1.0nF	±2%	CL21C102GBCNNN □		
		10pF	±5%	CL21C100JBCNNN □			1.0nF	±5%	CL21C102JBCNNN □		
		11pF	±2%	CL21C110GBCNNN □			1.0nF	±10%	CL21C102KBCNNN □		
		11pF	±5%	CL21C110JBCNNN □			1.35mm	25Vdc	270pF	±5%	CL21C271JAFNNN □
		12pF	±2%	CL21C120GBCNNN □					2.7nF	±5%	CL21C272JAFNNN □
		12pF	±5%	CL21C120JBCNNN □					3.3nF	±5%	CL21C332JAFNNN □
		13pF	±2%	CL21C130GBCNNN □					3.9nF	±5%	CL21C392JAFNNN □
		15pF	±2%	CL21C150GBCNNN □					4.7nF	±5%	CL21C472JAFNNN □
		15pF	±5%	CL21C150JBCNNN □					4.7nF	±10%	CL21C472KAFNNN □
		16pF	±2%	CL21C160GBCNNN □					8.2nF	±5%	CL21C822JAFNNN □
		18pF	±2%	CL21C180GBCNNN □					10nF	±2%	CL21C103GAFNNN □
		18pF	±5%	CL21C180JBCNNN □					10nF	±5%	CL21C103JAFNNN □
		20pF	±2%	CL21C200GBCNNN □					50Vdc	50Vdc	1.2nF
		20pF	±5%	CL21C200JBCNNN □			1.2nF	±2%			CL21C122GBFNNN □
		22pF	±2%	CL21C220GBCNNN □			1.2nF	±5%			CL21C122JBFNNN □
		22pF	±5%	CL21C220JBCNNN □			1.3nF	±5%			CL21C132JBFNNN □
		24pF	±2%	CL21C240GBCNNN □			1.5nF	±1%			CL21C152FBFNNN □
		30pF	±2%	CL21C300GBCNNN □			1.5nF	±2%			CL21C152GBFNNN □
		30pF	±5%	CL21C300JBCNNN □			1.5nF	±5%			CL21C152JBFNNN □
		36pF	±2%	CL21C360GBCNNN □			1.6nF	±5%			CL21C162JBFNNN □
		36pF	±5%	CL21C360JBCNNN □			1.8nF	±2%			CL21C182GBFNNN □
		39pF	±5%	CL21C390JBCNNN □			1.8nF	±5%			CL21C182JBFNNN □
		43pF	±2%	CL21C430GBCNNN □			2.0nF	±5%	CL21C202JBFNNN □		
		43pF	±5%	CL21C430JBCNNN □			2.2nF	±2%	CL21C222GBFNNN □		
		47pF	±5%	CL21C470JBCNNN □			2.2nF	±5%	CL21C222JBFNNN □		
		51pF	±5%	CL21C510JBCNNN □			2.7nF	±5%	CL21C272JBFNNN □		
		51pF	±10%	CL21C510KBCNNN □			3.3nF	±5%	CL21C332JBFNNN □		
		56pF	±2%	CL21C560GBCNNN □			3.9nF	±5%	CL21C392JBFNNN □		
		56pF	±5%	CL21C560JBCNNN □			4.7nF	±5%	CL21C472JBFNNN □		
		68pF	±5%	CL21C680JBCNNN □			5.6nF	±5%	CL21C562JBFNNN □		
		82pF	±5%	CL21C820JBCNNN □			6.8nF	±5%	CL21C682JBFNNN □		
		100pF	±5%	CL21C101JBCNNN □			10nF	±5%	CL21C103JBFNNN □		
		120pF	±1%	CL21C121FBCNNN □							
		120pF	±5%	CL21C121JBCNNN □							
120pF	±10%	CL21C121KBCNNN □									
150pF	±5%	CL21C151JBCNNN □									
180pF	±5%	CL21C181JBCNNN □									
220pF	±5%	CL21C221JBCNNN □									
300pF	±5%	CL21C301JBCNNN □									
330pF	±2%	CL21C331GBCNNN □									
470pF	±5%	CL21C471JBCNNN □									
510pF	±5%	CL21C511JBCNNN □									
560pF	±5%	CL21C561JBCNNN □									
600pF	±5%	CL21C601JBCNNN □									
620pF	±5%	CL21C621JBCNNN □									
680pF	±1%	CL21C681FBCNNN □									
680pF	±2%	CL21C681GBCNNN □									
680pF	±5%	CL21C681JBCNNN □									
750pF	±5%	CL21C751JBCNNN □									
820pF	±1%	CL21C821FBCNNN □									
820pF	±2%	CL21C821GBCNNN □									
820pF	±5%	CL21C821JBCNNN □									
910pF	±5%	CL21C911JBCNNN □									
1.0nF	±1%	CL21C102FBCNNN □									

■ Size : 3.20 X 1.60mm (inch : 1206)

Thickness Max.	Rated Voltage	Capacitance	Capacitance Tolerance	Part Number
1.00mm	25Vdc	330pF	±5%	CL31C331JACNNN □
		470pF	±10%	CL31C471KACNNN □
	50Vdc	0.5pF	±0.25pF	CL31C0R5CBCNNN □
		1.0pF	±0.25pF	CL31C010CBCNNN □
		1.2pF	±0.25pF	CL31C1R2CBCNNN □
		1.8pF	±0.25pF	CL31C1R8CBCNNN □
		2.0pF	±0.25pF	CL31C020CBCNNN □
		2.2pF	±0.25pF	CL31C2R2CBCNNN □
		2.7pF	±0.1pF	CL31C2R7BCCNNN □
		2.7pF	±0.25pF	CL31C2R7CBCNNN □
		3.0pF	±0.25pF	CL31C030CBCNNN □
		3.3pF	±0.25pF	CL31C3R3CBCNNN □
		3.9pF	±0.1pF	CL31C3R9BCCNNN □
		4.3pF	±0.1pF	CL31C4R3BCCNNN □
		4.7pF	±0.25pF	CL31C4R7CBCNNN □
		5.6pF	±0.25pF	CL31C5R6CBCNNN □
		5.6pF	±0.5pF	CL31C5R6DBCNNN □

※ □ mark means packaging code. If you want to learn the code or quantity in detail, please see p.148
In order to move to the page directly, please click the here. ↑

Standard & High Capacitors

Product Line Up (COG)

■ Size : 3.20 X 1.60mm (inch : 1206)

Thickness Max.	Rated Voltage	Capacitance	Capacitance Tolerance	Part Number	Thickness Max.	Rated Voltage	Capacitance	Capacitance Tolerance	Part Number
1.00mm	50Vdc	6.0pF	±0.5pF	CL31C060DBCNNN□	1.00mm	50Vdc	200pF	±5%	CL31C201JBCNNN□
		6.8pF	±0.25pF	CL31C6R8CBCNNN□			220pF	±1%	CL31C221FBCNNN□
		8.0pF	±0.25pF	CL31C080CBCNNN□			220pF	±2%	CL31C221GBCNNN□
		8.2pF	±0.25pF	CL31C8R2CBCNNN□			220pF	±5%	CL31C221JBCNNN□
		10pF	±0.5pF	CL31C100DBCNNN□			240pF	±5%	CL31C241JBCNNN□
		10pF	±5%	CL31C100JBCNNN□			270pF	±5%	CL31C271JBCNNN□
		11pF	±5%	CL31C110JBCNNN□			300pF	±5%	CL31C301JBCNNN□
		12pF	±5%	CL31C120JBCNNN□			330pF	±1%	CL31C331FBCNNN□
		13pF	±5%	CL31C130JBCNNN□			330pF	±2%	CL31C331GBCNNN□
		15pF	±5%	CL31C150JBCNNN□			330pF	±5%	CL31C331JBCNNN□
		15pF	±10%	CL31C150KBCNNN□			360pF	±1%	CL31C361FBCNNN□
		16pF	±5%	CL31C160JBCNNN□			360pF	±5%	CL31C361JBCNNN□
		18pF	±5%	CL31C180JBCNNN□			390pF	±1%	CL31C391FBCNNN□
		20pF	±2%	CL31C200GBCNNN□			390pF	±2%	CL31C391GBCNNN□
		20pF	±5%	CL31C200JBCNNN□			390pF	±5%	CL31C391JBCNNN□
		22pF	±1%	CL31C220FBCNNN□			430pF	±5%	CL31C431JBCNNN□
		22pF	±5%	CL31C220JBCNNN□			470pF	±1%	CL31C471FBCNNN□
		24pF	±2%	CL31C240GBCNNN□			470pF	±2%	CL31C471GBCNNN□
		24pF	±5%	CL31C240JBCNNN□			470pF	±5%	CL31C471JBCNNN□
		25pF	±5%	CL31C250JBCNNN□			470pF	±10%	CL31C471KBCNNN□
		27pF	±1%	CL31C270FBCNNN□			510pF	±5%	CL31C511JBCNNN□
		27pF	±2%	CL31C270GBCNNN□			560pF	±1%	CL31C561FBCNNN□
		27pF	±5%	CL31C270JBCNNN□			560pF	±5%	CL31C561JBCNNN□
		30pF	±5%	CL31C300JBCNNN□			620pF	±5%	CL31C621JBCNNN□
		33pF	±1%	CL31C330FBCNNN□			680pF	±1%	CL31C681FBCNNN□
		33pF	±5%	CL31C330JBCNNN□			680pF	±2%	CL31C681GBCNNN□
		36pF	±5%	CL31C360JBCNNN□			680pF	±5%	CL31C681JBCNNN□
		38pF	±2%	CL31C380GBCNNN□			750pF	±5%	CL31C751JBCNNN□
		39pF	±2%	CL31C390GBCNNN□			820pF	±5%	CL31C821JBCNNN□
		39pF	±5%	CL31C390JBCNNN□			910pF	±5%	CL31C911JBCNNN□
		43pF	±2%	CL31C430GBCNNN□			1.0nF	±1%	CL31C102FBCNNN□
		43pF	±5%	CL31C430JBCNNN□			1.0nF	±2%	CL31C102GBCNNN□
		47pF	±5%	CL31C470JBCNNN□			1.0nF	±5%	CL31C102JBCNNN□
		47pF	±10%	CL31C470KBCNNN□			1.2nF	±2%	CL31C122GBCNNN□
		51pF	±5%	CL31C510JBCNNN□			1.2nF	±5%	CL31C122JBCNNN□
		56pF	±2%	CL31C560GBCNNN□			1.5nF	±2%	CL31C152GBCNNN□
		56pF	±5%	CL31C560JBCNNN□			1.5nF	±5%	CL31C152JBCNNN□
		62pF	±5%	CL31C620JBCNNN□			1.8nF	±2%	CL31C182GBCNNN□
		68pF	±2%	CL31C680GBCNNN□			1.8nF	±5%	CL31C182JBCNNN□
		68pF	±5%	CL31C680JBCNNN□			2.0nF	±5%	CL31C202JBCNNN□
82pF	±5%	CL31C820JBCNNN□	2.2nF	±1%	CL31C222FBCNNN□				
91pF	±5%	CL31C910JBCNNN□	2.2nF	±2%	CL31C222GBCNNN□				
100pF	±2%	CL31C101GBCNNN□	2.2nF	±5%	CL31C222JBCNNN□				
100pF	±5%	CL31C101JBCNNN□	1.40mm	25Vdc	4.7nF	±2%	CL31C472GAFNNN□		
100pF	±10%	CL31C101KBCNNN□			8.2nF	±2%	CL31C822GAFNNN□		
110pF	±5%	CL31C111JBCNNN□			8.2nF	±5%	CL31C822JAFNNN□		
120pF	±5%	CL31C121JBCNNN□	10nF	±2%	CL31C103GAFNNN□				
130pF	±5%	CL31C131JBCNNN□	10nF	±5%	CL31C103JAFNNN□				
150pF	±5%	CL31C151JBCNNN□	50Vdc	2.7nF	±5%	CL31C272JBFNNN□			
160pF	±5%	CL31C161JBCNNN□		3.0nF	±5%	CL31C302JBFNNN□			
160pF	±10%	CL31C161KBCNNN□		3.3nF	±1%	CL31C332JBFNNN□			
180pF	±1%	CL31C181FBCNNN□		3.3nF	±2%	CL31C332JBFNNN□			
180pF	±2%	CL31C181GBCNNN□		3.3nF	±5%	CL31C332JBFNNN□			
180pF	±5%	CL31C181JBCNNN□		3.3nF	±10%	CL31C332KBFNNN□			

※ □ mark means packaging code. If you want to learn the code or quantity in detail, please see p.148
 In order to move to the page directly, please click the here. †

Product Line Up (COG)

■ Size : 3.20 X 1.60mm (inch : 1206)

Thickness Max.	Rated Voltage	Capacitance	Capacitance Tolerance	Part Number	
1.40mm	50Vdc	3.6nF	±5%	CL31C362JBFNNN □	
		3.9nF	±5%	CL31C392JBFNNN □	
		4.7nF	±1%	CL31C472JBFNNN □	
		4.7nF	±2%	CL31C472GBFNNN □	
		4.7nF	±5%	CL31C472JBFNNN □	
1.80mm	16Vdc	120nF	±5%	CL31C124JOHNNN □	
		25Vdc	6.8nF	±2%	CL31C682GAHNNN □
			8.2nF	±5%	CL31C822JAHNNN □
			10nF	±5%	CL31C103JAHNNN □
			39nF	±5%	CL31C393JAHNNN □
			47nF	±5%	CL31C473JAHNNN □
			56nF	±5%	CL31C563JAHNNN □
	68nF		±5%	CL31C683JAHNNN □	
	50Vdc	82nF	±5%	CL31C823JAHNNN □	
		100nF	±5%	CL31C104JAHNNN □	
		5.6nF	±5%	CL31C562JBHNNN □	
		6.8nF	±5%	CL31C682JBHNNN □	
		10nF	±2%	CL31C103GBHNNN □	
		15nF	±5%	CL31C153JBHNNN □	
18nF		±5%	CL31C183JBHNNN □		
1.80mm	50Vdc	22nF	±5%	CL31C223JBHNNN □	
		27nF	±5%	CL31C273JBHNNN □	
		33nF	±5%	CL31C333JBHNNN □	
		47nF	±5%	CL31C473JBHNNN □	

■ Size : 3.20 X 2.50mm (inch : 1210)

Thickness Max.	Rated Voltage	Capacitance	Capacitance Tolerance	Part Number
1.45mm	25Vdc	10nF	±5%	CL32C103JAFNNN □
	50Vdc	1.0nF	±5%	CL32C102JBFNNN □
		1.2nF	±5%	CL32C122JBFNNN □
		1.5nF	±5%	CL32C152JBFNNN □
		1.8nF	±5%	CL32C182JBFNNN □
		2.7nF	±5%	CL32C272JBFNNN □
		3.9nF	±5%	CL32C392JBFNNN □
		4.7nF	±5%	CL32C472JBFNNN □
		5.6nF	±5%	CL32C562JBFNNN □
		6.8nF	±5%	CL32C682JBFNNN □
		8.2nF	±1%	CL32C822JBFNNN □
	8.2nF	±5%	CL32C822JBFNNN □	
	10nF	±1%	CL32C103JBFNNN □	
	10nF	±2%	CL32C103GBFNNN □	
10nF	±5%	CL32C103JBFNNN □		
1.80mm	50Vdc	11nF	±5%	CL32C113JBHNNN □

※ □ mark means packaging code. If you want to learn the code or quantity in detail, please see p.148
In order to move to the page directly, please click the here. ↑

Standard & High Capacitors

Product Line Up (X5R)

■ Size : 1.00 X 0.50mm (inch : 0402)

Thickness Max.	Rated Voltage	Capacitance	Capacitance Tolerance	Part Number	Remark	Thickness Max.	Rated Voltage	Capacitance	Capacitance Tolerance	Part Number	Remark	
0.11mm	6.3Vdc	220nF	±20%	CL05A224MQLHEC□	Derating Ref.	0.55mm	16Vdc	100nF	±5%	CL05A104J05NNN□		
0.22mm	6.3Vdc	470nF	±20%	CL05A474MQXLNN□	Derating Ref.			100nF	±10%	CL05A104K05NNN□		
		1.0uF	±20%	CL05A105MQXLNN□	Derating Ref.			100nF	±20%	CL05A104M05NNN□		
0.33mm	4.0Vdc	2.2uF	±20%	CL05A225MR3LRN□	Derating Ref.			220nF	±10%	CL05A224K05NNN□		
	6.3Vdc	1.0uF	±20%	CL05A105MQ3LNN□	Derating Ref.			470nF	±10%	CL05A474K05NNN□	Derating	
		2.2uF	±20%	CL05A225MQ3LRN□	Derating Ref.			1.0uF	±10%	CL05A105K05NNN□	Derating	
0.35mm	6.3Vdc	4.7uF	±20%	CL05A475MQ3LUN□	Derating Ref.			4.2uF	±10%	CL05A425K05LUN□	Derating Ref.	
0.55mm	4.0Vdc	100nF	±20%	CL05A104MR5NNN□				25Vdc	100nF	±10%	CL05A104KA5NNN□	
		1.0uF	±20%	CL05A105MR5NNN□	Derating				220nF	±10%	CL05A224KA5NNN□	
		1.3uF	±10%	CL05A135KR5NNN□	Derating				330nF	±10%	CL05A334KA5NNN□	
		1.4uF	±10%	CL05A145KR5NNN□	Derating	330nF	±20%		CL05A334MA5NNN□			
		1.5uF	±10%	CL05A155KR5NNN□	Derating	470nF	±10%		CL05A474KA5NNN□			
		1.7uF	±10%	CL05A175KR5NNN□	Derating	1.0uF	±10%		CL05A105KA5NNN□	Derating		
		1.8uF	±10%	CL05A185KR5NNN□	Derating							
		2.2uF	±20%	CL05A225MR5NNN□	Derating Ref.							
		3.3uF	±20%	CL05A335MR5NNN□	Derating Ref.							
	6.3Vdc	100nF	±10%	CL05A104KQ5NNN□		0.57mm	4.0Vdc	2.2uF	±20%	CL05A225MR5NSN□	Derating Ref.	
			±20%	CL05A104MQ5NNN□			6.3Vdc	2.2uF	±10%	CL05A225KQ5NSN□	Ref.	
			120nF	±10%	CL05A124KQ5NNN□			10Vdc	2.2uF	±10%	CL05A225KQ5NSN□	Derating Ref.
			150nF	±10%	CL05A154KQ5NNN□			2.2uF	±20%	CL05A225MQ5NSN□	Ref.	
			220nF	±5%	CL05A224JQ5NNN□		0.60mm	4.0Vdc	4.7uF	±20%	CL05A475MR5NQ□	Derating Ref.
			220nF	±10%	CL05A224KQ5NNN□			6.3Vdc	4.7uF	±20%	CL05A475MQ5NQ□	Derating Ref.
			220nF	±20%	CL05A224MQ5NNN□			16Vdc	2.2uF	±10%	CL05A225K05NQ□	Derating Ref.
			330nF	±10%	CL05A334KQ5NNN□				2.2uF	±20%	CL05A225M05NQ□	Derating Ref.
			330nF	±20%	CL05A334MQ5NNN□		25Vdc	1uF	±10%	CL05A105KA5NQ□	Derating	
			470nF	±10%	CL05A474KQ5NNN□			1uF	±20%	CL05A105MA5NQ□	Derating	
680nF	±10%	CL05A684KQ5NNN□		0.65mm	4.0Vdc	10uF	±20%	CL05A106MR5NR□	Derating Ref.			
1.0uF	±5%	CL05A105JQ5NNN□	Derating		6.3Vdc	4.7uF	±10%	CL05A475KQ5NR□	Derating Ref.			
1.0uF	±10%	CL05A105KQ5NNN□	Derating				4.7uF	±20%	CL05A475MQ5NR□	Derating Ref.		
1.0uF	±20%	CL05A105MQ5NNN□	Derating			10uF	±20%	CL05A106MQ5NR□	Derating Ref.			
2.2uF	±10%	CL05A225KQ5NNN□	Derating Ref.			13uF	±20%	CL05A136MQ5NR□	Derating Ref.			
2.2uF	±20%	CL05A225MQ5NNN□	Derating Ref.		10Vdc	4.7uF	±10%	CL05A475KP5NR□	Derating Ref.			
							4.7uF	±20%	CL05A475MP5NR□	Derating Ref.		
							10uF	±20%	CL05A106MP5NR□	Derating Ref.		
							10uF	±20%	CL05A106MP5NR□	Derating Ref.		
10Vdc	10nF	±10%	CL05A103KP5NNN□			35Vdc	1uF	±10%	CL05A105KL5NR□	Derating		
		±20%	CL05A103MP5NNN□									
		47nF	±10%	CL05A473KP5NNN□		0.70mm	4.0Vdc	2.2uF	±20%	CL05A225MR5NUN□	Derating	
		47nF	±20%	CL05A473MP5NNN□				10uF	±20%	CL05A106MR5NUN□	Derating Ref.	
		68nF	±10%	CL05A683KP5NNN□			6.3Vdc	10uF	±20%	CL05A106MQ5NUN□	Derating Ref.	
		82nF	±10%	CL05A823KP5NNN□					22uF	±20%	CL05A226MQ5QUN□	Derating
		100nF	±10%	CL05A104KP5NNN□			10Vdc	10uF	±20%	CL05A106MP5NUN□	Derating Ref.	
		100nF	±20%	CL05A104MP5NNN□				16Vdc	4.7uF	±20%	CL05A475M05NUN□	Derating Ref.
		150nF	±10%	CL05A154KP5NNN□			25Vdc		2.2uF	±10%	CL05A225KA5NUN□	Derating Ref.
		220nF	±10%	CL05A224KP5NNN□					2.2uF	±20%	CL05A225MA5NUN□	Derating Ref.
		220nF	±20%	CL05A224MP5NNN□								
		330nF	±10%	CL05A334KP5NNN□			0.75mm	6.3Vdc	22uF	±20%	CL05A226MQ5N6J□	Derating
		330nF	±20%	CL05A334MP5NNN□		0.80mm	6.3Vdc	22uF	±20%	CL05A226MQ6NUN□	Derating	
		470nF	±10%	CL05A474KP5NNN□				10Vdc	10uF	±20%	CL05A106MP6NUN□	Derating Ref.
		1.0uF	±5%	CL05A105JP5NNN□		0.85mm	6.3Vdc	22uF	±20%	CL05A226MQ6N6J□	Derating	
		1.0uF	±10%	CL05A105KP5NNN□			0.90mm	4.0Vdc	22uF	±20%	CL05A226MR5NZN□	Derating Ref.
		1.0uF	±20%	CL05A105MP5NNN□								
		2.2uF	±10%	CL05A225KP5NNN□	Derating Ref.							
		2.2uF	±20%	CL05A225MP5NNN□	Derating Ref.							
16Vdc	4.7nF	±10%	CL05A472K05NNN□									
		±20%	CL05A472K05NNN□									
		47nF	±10%	CL05A473K05NNN□								
		47nF	±20%	CL05A473M05NNN□								

* □ mark means packaging code. If you want to learn the code or quantity in detail, please see p.148

In order to move to the page directly, please click the here. ↑

Product Line Up (X5R)

■ Size : 1.60 X 0.80mm (inch : 0603)

Thickness Max.	Rated Voltage	Capacitance	Capacitance Tolerance	Part Number	Remark	Thickness Max.	Rated Voltage	Capacitance	Capacitance Tolerance	Part Number	Remark	
0.50mm	4.0Vdc	10uF	±20%	CL10A106MR5LQN□	Derating Ref.	0.90mm	16Vdc	1.0uF	±10%	CL10A105K08NINN□		
		2.2uF	±10%	CL10A225KQ5LNN□				1.0uF	±20%	CL10A105M08NINN□		
		4.7uF	±10%	CL10A475KQ5LNN□				2.2uF	±10%	CL10A225K08NINN□		
		4.7uF	±20%	CL10A475MQ5LNN□				4.7uF	±10%	CL10A475K08NINN□	Derating	
	10uF	±20%	CL10A106MQ5LNN□	Derating Ref.	4.7uF			±20%	CL10A475M08NINN□	Derating		
	10Vdc	1.0uF	±10%	CL10A105KP5LNN□				25Vdc	100nF	±10%	CL10A104K8NINN□	
		2.2uF	±10%	CL10A225KP5LNN□			220nF		±10%	CL10A224K8NINN□		
		4.7uF	±10%	CL10A475KP5LNN□	Derating		220nF		±20%	CL10A224MA8NINN□		
		4.7uF	±20%	CL10A475MP5LNN□	Derating		330nF		±10%	CL10A334K8NINN□		
	16Vdc	1.0uF	±10%	CL10A105K05LNN□			470nF		±10%	CL10A474K8NINN□		
		2.2uF	±10%	CL10A225K05LNN□	Derating		1.0uF		±10%	CL10A105K8NINN□		
		25Vdc	1.0uF	±10%	CL10A105K8NINN□		Derating	2.2uF	±10%	CL10A225K8NINN□	Derating	
2.2uF			±10%	CL10A225K8NINN□	Derating	35Vdc	1.0uF	±10%	CL10A105K8NINN□			
0.60mm	6.3Vdc	4.7uF	±10%	CL10A475KQ5NINN□			2.2uF	±10%	CL10A225K8NINN□	Derating		
		4.7uF	±20%	CL10A475MQ5NINN□			50Vdc	100nF	±10%	CL10A104K8NINN□		
0.80mm	6.3Vdc	22uF	±20%	CL10A226MQ7LUN□	Derating			220nF	±10%	CL10A224K8NINN□		
	10Vdc	22uF	±20%	CL10A226MP7LUN□	Derating			470nF	±10%	CL10A474K8NINN□		
	16Vdc	22uF	±20%	CL10A226M07JZN□	Derating			1.0uF	±10%	CL10A105K8NINN□		
0.90mm	4.0Vdc	2.2uF	±20%	CL10A225MR8NINN□		0.95mm	4.0Vdc	22uF	±20%	CL10A226MR8NQN□	Derating	
		4.7uF	±20%	CL10A475MR8NINN□	Derating			6.3Vdc	4.7uF	±20%	CL10A475MQ8NQN□	
		10uF	±10%	CL10A106KR8NINN□	Derating Ref.		10uF		±20%	CL10A106MQ8NQN□		
		10uF	±20%	CL10A106MR8NINN□	Derating Ref.		16Vdc	4.7uF	±10%	CL10A475K08NQN□	Derating	
	22uF	±20%	CL10A226MR8NINN□	Derating	10uF			±10%	CL10A106K08NQN□	Derating Ref.		
	6.3Vdc	470nF	±10%	CL10A474KQ8NINN□				10uF	±20%	CL10A106M08NQN□	Derating Ref.	
		470nF	±20%	CL10A474MQ8NINN□		25Vdc		4.7uF	±10%	CL10A475K8NQN□	Derating	
		680nF	±10%	CL10A684KQ8NINN□			4.7uF	±20%	CL10A475MA8NQN□	Derating		
		1.0uF	±10%	CL10A105KQ8NINN□		1.00mm	4.0Vdc	47uF	±20%	CL10A476MR8NRN□	Derating Ref.	
	1.0uF	±20%	CL10A105MQ8NINN□		6.3Vdc			10uF	±20%	CL10A106MQ8NRN□	Ref.	
	2.2uF	±10%	CL10A225KQ8NINN□				22uF	±10%	CL10A226KQ8NRN□	Derating		
	2.2uF	±20%	CL10A225MQ8NINN□				22uF	±20%	CL10A226MQ8NRN□	Derating		
	3.3uF	±10%	CL10A335KQ8NINN□				47uF	±20%	CL10A476MQ8QRN□	Derating		
	3.3uF	±20%	CL10A335MQ8NINN□		10Vdc		22uF	±20%	CL10A226MP8NRN□	Derating		
	4.7uF	±10%	CL10A475KQ8NINN□				25Vdc	10uF	±20%	CL10A106MA8NRN□	Derating Ref.	
	4.7uF	±20%	CL10A475MQ8NINN□		35Vdc			4.7uF	±10%	CL10A475K8NRN□	Derating	
	10uF	±10%	CL10A106KQ8NINN□	Ref.			1.05mm	6.3Vdc	22uF	±20%	CL10A226MQ8NUN□	Derating
	10uF	±20%	CL10A106MQ8NINN□	Ref.	10Vdc				22uF	±20%	CL10A226MP8NUN□	Derating
	22uF	±20%	CL10A226MQ7NRN□	Ref.				1.10mm	4.0Vdc	47uF	±20%	CL10A476MR8NZN□
	10Vdc	220nF	±10%	CL10A224KP8NINN□						6.3Vdc	47uF	±20%
		330nF	±10%	CL10A334KP8NINN□		16Vdc	330nF	±10%	CL10A334K08NINN□			
		470nF	±10%	CL10A474KP8NINN□			470nF	±10%	CL10A474K08NINN□			
		680nF	±10%	CL10A684KP8NINN□								
		820nF	±10%	CL10A824KP8NINN□								
		1.0uF	±10%	CL10A105KP8NINN□								
		1.0uF	±20%	CL10A105MP8NINN□								
		2.2uF	±10%	CL10A225KP8NINN□								
		2.2uF	±20%	CL10A225MP8NINN□								
		3.3uF	±10%	CL10A335KP8NINN□								
		3.3uF	±20%	CL10A335MP8NINN□								
		4.7uF	±10%	CL10A475KP8NINN□								
	4.7uF	±20%	CL10A475MP8NINN□									
	10uF	±10%	CL10A106KP8NINN□	Derating Ref.								
	10uF	±20%	CL10A106MP8NINN□	Derating Ref.								

※ □ mark means packaging code. If you want to learn the code or quantity in detail, please see p.148

In order to move to the page directly, please click the here. ↑

Standard & High Capacitors

Product Line Up (X5R)

■ Size : 2.00 X 1.25mm (inch : 0805)

Thickness Max.	Rated Voltage	Capacitance	Capacitance Tolerance	Part Number	Remark	Thickness Max.	Rated Voltage	Capacitance	Capacitance Tolerance	Part Number	Remark	
0.70mm	10Vdc	2.2uF	±10%	CL21A225KP6LNN □		1.35mm	6.3Vdc	2.2uF	±20%	CL21A225MQFNNN □		
		1.0uF	±20%	CL21A105M06LNN □				3.3uF	±10%	CL21A335KQFNNN □		
	2.2uF	±10%	CL21A225K06LNN □		3.3uF			±20%	CL21A335MQFNNN □			
0.80mm	6.3Vdc	10uF	±10%	CL21A106KQ7LQN □				4.7uF	±10%	CL21A475KQFNNN □		
		47uF	±20%	CL21A476MQ7FRN □	Derating			4.7uF	±20%	CL21A475MQFNNN □		
		47uF	±20%	CL21A476MQ7LRN □	Derating			6.8uF	±10%	CL21A685KQFNNN □		
	10Vdc	10uF	±10%	CL21A106KP7LQN □	Derating			10uF	±10%	CL21A106KQFNNN □		
0.90mm	6.3Vdc	47uF	±20%	CL21A476MQ8LRN □	Derating			10uF	±20%	CL21A106MQFNNN □		
0.95mm	4.0Vdc	22uF	±20%	CL21A226MRCLRN □	Derating			10Vdc	1.0uF	±10%	CL21A105KPFNNN □	
		47uF	±20%	CL21A476MRCLRP □	Derating				2.2uF	±10%	CL21A225KPFNNN □	
6.3Vdc	1.0uF	±10%	CL21A105KQCLNN □		2.2uF				±20%	CL21A225MPFNNN □		
	1.0uF	±10%	CL21A105KQCNNN □		2.2uF				±20%	CL21A225MPFNNN □		
	4.7uF	±10%	CL21A475KQCLNN □		3.3uF		±10%		CL21A335KPFNNN □			
	4.7uF	±20%	CL21A475MQCLNN □		4.7uF		±10%		CL21A475KPFNNN □			
	10uF	±10%	CL21A106KQCLNN □		4.7uF		±20%		CL21A475MPFNNN □			
	10uF	±10%	CL21A106KQCLRN □		10uF		±10%		CL21A106KPFNNN □			
	10uF	±20%	CL21A106MQCLNN □		10uF		±20%		CL21A106MPFNNN □			
	22uF	±10%	CL21A226KQCLRN □	Derating	22uF		±10%		CL21A684KOFNNN □			
	22uF	±20%	CL21A226MQCLQN □	Derating	1.0uF		±10%		CL21A105KOFNNN □			
	22uF	±20%	CL21A226MQCLRN □	Derating	2.2uF		±10%		CL21A225KOFNNN □			
	47uF	±20%	CL21A476MQCLRN □	Derating	2.2uF		±20%	CL21A225MOFNNN □				
	10Vdc	2.2uF	±10%	CL21A225KPLNN □			3.3uF	±10%	CL21A335KOFNNN □			
4.7uF		±10%	CL21A475KPLNN □		4.7uF		±10%	CL21A475KOFNNN □				
4.7uF		±20%	CL21A475MPCLNN □		10uF		±10%	CL21A106KOFNNN □	Derating			
10uF		±10%	CL21A106KPLNN □	Derating	25Vdc	470nF	±20%	CL21A474MAFNNN □				
10uF		±10%	CL21A106KPLQN □	Derating		1.0uF	±10%	CL21A105KAFNNN □				
10uF		±20%	CL21A106MPCLNN □	Derating		2.2uF	±10%	CL21A225KAFNNN □				
10uF		±20%	CL21A106MPCLQN □	Derating	50Vdc	1.0uF	±10%	CL21A105KBFNNN □	Derating			
22uF		±10%	CL21A226KPCLRN □	Derating		2.2uF	±10%	CL21A225KBFNNN □	Derating			
22uF		±20%	CL21A226MPCLRN □	Derating	1.40mm	4.0Vdc	22uF	±20%	CL21A226MRQNNN □			
22uF		+80/-20%	CL21A226ZPCLRN □	Derating			47uF	±20%	CL21A476MRQNNN □	Derating		
16Vdc		2.2uF	±10%	CL21A225KOCLNN □				6.3Vdc	4.7uF	±10%	CL21A475KQQNNN □	Derating
		4.7uF	±10%	CL21A475KOCLNN □			10uF	±10%	CL21A106KQQNNN □	Derating		
	4.7uF	±10%	CL21A475KOCLRN □			22uF	±10%	CL21A226KQQNNN □				
10uF	±10%	CL21A106KOCLNN □	Derating	22uF		±20%	CL21A226MQQNNN □					
10uF	±10%	CL21A106KOCLRN □	Derating	10Vdc		22uF	±20%	CL21A226MPQNNN □				
10uF	±10%	CL21A106KOCLSN □	Derating			16Vdc	10uF	±10%	CL21A106KQQNNN □	Derating		
22uF	±20%	CL21A226MOCLRN □	Derating				22uF	±10%	CL21A226KQQNNN □	Derating		
25Vdc	1.0uF	±10%	CL21A105KACLNN □				22uF	±20%	CL21A226MOQNNN □	Derating		
	1.0uF	±10%	CL21A105KACNNN □			25Vdc	4.7uF	±10%	CL21A475KAQNNN □	Derating		
	2.2uF	±10%	CL21A225KACLNN □	Derating			4.7uF	±20%	CL21A475MAQNNN □	Derating		
	4.7uF	±10%	CL21A475KACLR □	Derating	22uF	±20%	CL21A226MAQNNN □	Derating				
10uF	±10%	CL21A106KACLR □	Derating	50Vdc	2.2uF	±10%	CL21A225KBQNNN □	Derating				
10uF	±10%	CL21A106KACLR □	Derating		4.7uF	±10%	CL21A475KBQNNN □	Derating				
35Vdc	4.7uF	±10%	CL21A475KLCQLN □	Derating	1.45mm	4.0Vdc	47uF	±20%	CL21A476MRYNNN □			
50Vdc	1.0uF	±10%	CL21A105KBCFNN □				6.3Vdc	47uF	±10%	CL21A476KQYNNN □	Derating	
	1.0uF	±10%	CL21A105KBCLNN □				47uF	±20%	CL21A476MQYNNN □	Derating		
1.00mm	6.3Vdc	33uF	±20%	CL21A336MQ9LRN □	Derating	25Vdc	10uF	±10%	CL21A106KAYNNN □	Derating		
		47uF	±20%	CL21A476MQ9LRN □	Derating							
	50Vdc	2.2uF	±10%	CL21A225KB9LNN □	Derating							
1.20mm	6.3Vdc	33uF	±20%	CL21A336MQELRN □	Derating							
	10Vdc	2.2uF	±10%	CL21A225KPENNN □								
1.25mm	6.3Vdc	47uF	±20%	CL21A476MQMNRN □	Derating							
1.35mm	4.0Vdc	10uF	±20%	CL21A106MRFNNN □								
	6.3Vdc	2.2uF	±10%	CL21A225KQFNNN □								

* □ mark means packaging code. If you want to learn the code or quantity in detail, please see p.148

In order to move to the page directly, please click the here. ↑

Product Line Up (X5R)

■ Size : 3.20 X 1.60mm (inch : 1206)

Thickness Max.	Rated Voltage	Capacitance	Capacitance Tolerance	Part Number	Remark	
0.95mm	6.3Vdc	10uF	±20%	CL31A106MQCLNN □		
		22uF	±10%	CL31A226KQCLNN □	Derating	
		22uF	±20%	CL31A226MQCLNN □	Derating	
	10Vdc	10uF	±10%	CL31A106KPCLNN □		
		10uF	±20%	CL31A106MPCLNN □		
	16Vdc	2.2uF	±10%	CL31A225KQCLNN □		
		4.7uF	±10%	CL31A475KQCLNN □		
		4.7uF	±20%	CL31A475MOCLNN □		
		10uF	±10%	CL31A106KQCLNN □		
		22uF	±10%	CL31A226KQCLNN □	Derating	
	25Vdc	22uF	±20%	CL31A226MOCLNN □	Derating	
		4.7uF	±10%	CL31A475KACLNN □		
		10uF	±10%	CL31A106KACLNN □	Derating	
		10uF	±20%	CL31A106MACLNN □	Derating	
1.00mm	35Vdc	4.7uF	±10%	CL31A475KL9LNN □	Derating	
	50Vdc	1.0uF	±10%	CL31A105KB9LNN □		
		2.2uF	±10%	CL31A225KB9LNN □		
		4.7uF	±10%	CL31A475KB9LNN □	Derating	
100Vdc	2.2uF	±10%	CL31A225KC9LNN □	Derating		
1.20mm	16Vdc	4.7uF	±10%	CL31A475KOELNN □		
1.25mm	10Vdc	10uF	±10%	CL31A106KPPLNN □		
		10uF	±20%	CL31A106MPPLNN □		
	16Vdc	4.7uF	±10%	CL31A475KOPLNN □		
		4.7uF	±20%	CL31A475MOPLNN □		
	25Vdc	1.0uF	±10%	CL31A105KAPLNN □		
		2.2uF	±10%	CL31A225KAPLNN □		
4.7uF	±10%	CL31A475KAPLNN □				
1.70mm	50Vdc	2.2uF	±10%	CL31A225KBTLNN □		
1.80mm	6.3Vdc	3.3uF	±10%	CL31A335KQHNNN □		
		10uF	±10%	CL31A106KQHNNN □		
		10uF	±20%	CL31A106MQHNNN □		
		15uF	±10%	CL31A156KQHNNN □		
		15uF	±20%	CL31A156MQHNNN □		
		22uF	±10%	CL31A226KQHNNN □		
		22uF	±20%	CL31A226MQHNNN □		
		33uF	±20%	CL31A336MQHNNN □		
		47uF	±10%	CL31A476KQHNNN □		
		47uF	±20%	CL31A476MQHNNN □		
		100uF	±20%	CL31A107MQHNNN □	Derating	
		10Vdc	3.3uF	±10%	CL31A335KPHNNN □	
			4.7uF	±10%	CL31A475KPHNNN □	
	10uF		±10%	CL31A106KPHNNN □		
	10uF		±20%	CL31A106MPHNNN □		
	22uF		±10%	CL31A226KPHNNN □		
	22uF		±20%	CL31A226MPHNNN □		
	47uF		±20%	CL31A476MPHNNN □	Derating	
	100uF	±20%	CL31A107MPHNNN □	Derating		
	16Vdc	2.2uF	±10%	CL31A225KOHNNN □		
		3.3uF	±10%	CL31A335KOHNNN □		
		3.3uF	±20%	CL31A335MOHNNN □		
		4.7uF	±10%	CL31A475KOHNNN □		
4.7uF		±20%	CL31A475MOHNNN □			
10uF		±10%	CL31A106KOHNNN □			
10uF		±20%	CL31A106MOHNNN □			
22uF		±10%	CL31A226KOHNNN □	Derating		

Thickness Max.	Rated Voltage	Capacitance	Capacitance Tolerance	Part Number	Remark
1.80mm	16Vdc	22uF	±20%	CL31A226MOHNNN □	Derating
	25Vdc	2.2uF	±10%	CL31A225KAHNNN □	
		3.3uF	±10%	CL31A335KAHNNN □	
		4.7uF	±10%	CL31A475KAHNNN □	
		10uF	±10%	CL31A106KAHNNN □	
		10uF	±20%	CL31A106MAHNNN □	
		22uF	±10%	CL31A226KAHNNN □	Derating
	22uF	±20%	CL31A226MAHNNN □	Derating	
	35Vdc	2.2uF	±10%	CL31A225KLHNNN □	
		2.2uF	±10%	CL31A225KBHNNN □	
	50Vdc	4.7uF	±10%	CL31A475KBHNNN □	
		10uF	±10%	CL31A106KBHNNN □	
	10uF	±20%	CL31A106MBHNNN □		

■ Size : 3.20 X 2.50mm (inch : 1210)

Thickness Max.	Rated Voltage	Capacitance	Capacitance Tolerance	Part Number	Remark	
0.95mm	16Vdc	10uF	±10%	CL32A106KQCLNN □		
		22uF	±20%	CL32A226MOCLNN □	Derating	
1.00mm	25Vdc	10uF	±10%	CL32A106KA9LNN □		
1.25mm	16Vdc	10uF	±10%	CL32A106KOMLNN □		
		22uF	±10%	CL32A226KPSLNN □		
1.50mm	10Vdc	22uF	±10%	CL32A226MPSLNN □		
		22uF	±20%	CL32A226MPSLNN □		
25Vdc	6.8uF	±10%	CL32A685KASLNN □			
		±10%	CL32A685KASLNN □			
1.70mm	16Vdc	22uF	±10%	CL32A226KOTFNN □	Derating	
		22uF	±20%	CL32A226MOTLNN □	Derating	
	25Vdc	10uF	±10%	CL32A106KATLNN □		
		10uF	±20%	CL32A106MATLNN □		
2.00mm	25Vdc	4.7uF	±10%	CL32A475KAULNN □		
		10uF	±10%	CL32A106KAULNN □		
		10uF	±20%	CL32A106MLLULNN □		
	35Vdc	4.7uF	±10%	CL32A475KLULNN □		
		10uF	±10%	CL32A106KLULNN □		
		10uF	±20%	CL32A106MLLULNN □		
2.20mm	10Vdc	10uF	±10%	CL32A106KPINNN □		
		10uF	±10%	CL32A106KOILNN □		
	25Vdc	2.2uF	±20%	CL32A225MAINNN □		
		4.7uF	±10%	CL32A475KAINNN □		
		10uF	±10%	CL32A106KAILNN □		
		10uF	±20%	CL32A106MAILNN □		
2.70mm	6.3Vdc	22uF	±10%	CL32A226KQJNNN □		
		22uF	±20%	CL32A226MQJNNN □		
		33uF	±20%	CL32A336MQJNNN □		
		47uF	±10%	CL32A476KQJNNN □		
		47uF	±20%	CL32A476MQJNNN □		
		47uF	±20%	CL32A476KQJNNN □		
	10Vdc	22uF	±10%	CL32A226KPJNNN □		
		22uF	±20%	CL32A226MPJNNN □	Derating	
		47uF	±10%	CL32A476KPJNNN □	Derating	
		47uF	±20%	CL32A476MPJNNN □		
		16Vdc	10uF	±10%	CL32A106KOJNNN □	
			10uF	±20%	CL32A106MOJNNN □	
22uF	±10%		CL32A226KOJNNN □			
22uF	±20%		CL32A226MOJNNN □			
47uF	±10%		CL32A476KOJNNN □			
47uF	±10%		CL32A476MOJNNN □			

※ □ mark means packaging code. If you want to learn the code or quantity in detail, please see p.148

In order to move to the page directly, please click the here. ↑

Standard & High Capacitors

Product Line Up (X5R)

■ Size : 3.20 X 2.50mm (inch : 1210)

Thickness Max.	Rated Voltage	Capacitance	Capacitance Tolerance	Part Number	Remark	
2.70mm	16Vdc	47uF	±20%	CL32A476MOJNNN□		
		25Vdc	10uF	±10%	CL32A106KAJNNN□	
			10uF	±20%	CL32A106MAJNNN□	
			22uF	±10%	CL32A226KAJNNN□	
	35Vdc	22uF	±20%	CL32A226MAJNNN□		
		50Vdc	10uF	±10%	CL32A106KJNNN□	
			10uF	±10%	CL32A106BJNNN□	
			10uF	±20%	CL32A106MJNNN□	
2.80mm	6.3Vdc	100uF	±20%	CL32A107MQVNNN□	Derating	
		150uF	±20%	CL32A157MQVNNN□	Derating	
		220uF	±20%	CL32A227MQVNNN□	Derating	
	10Vdc	100uF	±20%	CL32A107MPVNNN□	Derating	

■ Size : 4.50 X 3.20mm (inch : 1812)

Thickness Max.	Rated Voltage	Capacitance	Capacitance Tolerance	Part Number	Remark
2.70mm	6.3Vdc	33uF	±20%	CL43A336MQJNNN□	
		47uF	±10%	CL43A476KQJNNN□	
		47uF	±20%	CL43A476MQJNNN□	
3.50mm	6.3Vdc	100uF	±20%	CL43A107MLNNN□	

■ Size : 5.70 X 5.00mm (inch : 2220)

Thickness Max.	Rated Voltage	Capacitance	Capacitance Tolerance	Part Number	Remark
2.70mm	6.3Vdc	47uF	±20%	CL55A476MQJNNN□	
		68uF	±20%	CL55A686MQJNNN□	
		100uF	±20%	CL55A107MQJNNN□	
		10Vdc	47uF	±10%	CL55A476KPJNNN□

※ □ mark means packaging code. If you want to learn the code or quantity in detail, please see p.148
 In order to move to the page directly, please click the here. ↑

Product Line Up (X6S)

■ Size : 1.00 X 0.50mm (inch : 0402)

Thickness Max.	Rated Voltage	Capacitance	Capacitance Tolerance	Part Number	Remark
0.33mm	6.3Vdc	1.0uF	±20%	CL05X105MQ3LNN □	Derating
0.55mm	4.0Vdc	2.2nF	±20%	CL05X222MR5NNN □	
		15nF	±20%	CL05X153MR5NNN □	
		47nF	±20%	CL05X473MR5NNN □	
		220nF	±20%	CL05X224MR5NNN □	
		2.2uF	±20%	CL05X225MR5NNN □	Derating
	6.3Vdc	680nF	±5%	CL05X684JQ5NNN □	
			1.0uF	±10%	CL05X105KQ5NNN □
	10Vdc	1.0uF	±10%	CL05X105KP5NNN □	Derating
0.57mm	2.5Vdc	2.2uF	±20%	CL05X225MS5NSN □	Derating Ref.
0.60mm	25Vdc	1.0uF	±10%	CL05X105KA5NQN □	Derating
0.70mm	4.0Vdc	4.7uF	±20%	CL05X475MR5NUN □	Derating Ref.
		10uF	±20%	CL05X106MR5NUN □	Derating Ref.

■ Size : 1.60 X 0.80mm (inch : 0603)

Thickness Max.	Rated Voltage	Capacitance	Capacitance Tolerance	Part Number	Remark
0.90mm	4.0Vdc	1.0uF	±20%	CL10X105MR8NNN □	
		4.7uF	±20%	CL10X475MR8NNN □	Derating
		10uF	±10%	CL10X106KR8NNN □	Derating Ref.
		10uF	±20%	CL10X106MR8NNN □	Derating Ref.
	6.3Vdc	1.0uF	±20%	CL10X105MQ8NNN □	
		2.2uF	±10%	CL10X225KQ8NNN □	
		2.2uF	±20%	CL10X225MQ8NNN □	
		4.7uF	±10%	CL10X475KQ8NNN □	Derating
		4.7uF	±20%	CL10X475MQ8NNN □	Derating
		10uF	±10%	CL10X106KQ8NNN □	Derating Ref.
		10uF	±20%	CL10X106MQ8NNN □	Derating Ref.
10Vdc	2.2uF	±10%	CL10X225KP8NNN □		
25Vdc	1.0uF	±10%	CL10X105KA8NNN □		
0.95mm	25Vdc	4.7uF	±10%	CL10X475KA8NQN □	Derating
1.00mm	10Vdc	10uF	±20%	CL10X106MP8NRR □	Derating Ref.
		4.7uF	±10%	CL10X475KO8NRR □	Derating
	16Vdc	10uF	±20%	CL10X106MO8NRR □	Derating Ref.

■ Size : 2.00 X 1.25mm (inch : 0805)

Thickness Max.	Rated Voltage	Capacitance	Capacitance Tolerance	Part Number	Remark
0.95mm	2.5Vdc	22uF	±20%	CL21X226MSCLRN □	Derating
	4.0Vdc	10uF	±10%	CL21X106KRCLRN □	Derating
	10Vdc	10uF	±10%	CL21X106KPCLRN □	Derating
1.35mm	4.0Vdc	4.7uF	±10%	CL21X475KRFNNN □	
		10uF	±10%	CL21X106KRFNNN □	
		10uF	±20%	CL21X106MRFNNN □	
	16Vdc	2.2uF	±10%	CL21X225KOFNNN □	
1.40mm	4.0Vdc	22uF	±20%	CL21X226MRQNNN □	Derating
	6.3Vdc	10uF	±10%	CL21X106KQNNN □	Derating
		22uF	±20%	CL21X226MQNNN □	Derating
	16Vdc	10uF	±10%	CL21X106KOQNNN □	
		10uF	±20%	CL21X106MOQNNN □	
		4.7uF	±10%	CL21X475KAQNNN □	Derating
			4.7uF	±20%	CL21X475MAQNNN □
1.45mm	2.5Vdc	47uF	±20%	CL21X476MSYNNN □	Derating
	4.0Vdc	47uF	±20%	CL21X476MRYNNN □	Derating
	10Vdc	10uF	±10%	CL21X106KPYNNN □	
	25Vdc	10uF	±10%	CL21X106KAYNNN □	Derating
		10uF	±20%	CL21X106MAYNNN □	Derating

■ Size : 3.20 X 1.60mm (inch : 1206)

Thickness Max.	Rated Voltage	Capacitance	Capacitance Tolerance	Part Number	Remark
0.95mm	25Vdc	4.7uF	±10%	CL31X475KACLNN □	
1.80mm	4.0Vdc	10uF	±10%	CL31X106KRHNNN □	
		10uF	±20%	CL31X106MRHNNN □	
		22uF	±10%	CL31X226KRHNNN □	
		22uF	±20%	CL31X226MRHNNN □	
		47uF	±20%	CL31X476MRHNNN □	Derating
	6.3Vdc	10uF	±10%	CL31X106QHNNN □	
		10uF	±20%	CL31X106MQHNNN □	
		22uF	±10%	CL31X226KQHNNN □	
		47uF	±10%	CL31X476KQHNNN □	Derating
		47uF	±20%	CL31X476MQHNNN □	Derating
16Vdc	22uF	±10%	CL31X226KOHNNN □	Derating	
25Vdc	10uF	±10%	CL31X106KAHNNN □		

■ Size : 3.20 X 2.50mm (inch : 1210)

Thickness Max.	Rated Voltage	Capacitance	Capacitance Tolerance	Part Number	Remark
2.70mm	6.3Vdc	22uF	±20%	CL32X226MQJNNN □	
	10Vdc	47uF	±10%	CL32X476KJNNN □	
	16Vdc	10uF	±10%	CL32X106KJNNN □	
2.80mm	4.0Vdc	100uF	±10%	CL32X107KRVNNN □	
	6.3Vdc	100uF	±20%	CL32X107MQVNNN □	

※ □ mark means packaging code. If you want to learn the code or quantity in detail, please see p.148
In order to move to the page directly, please click the here. ↑

Standard & High Capacitors

Product Line Up (X7R)

■ Size : 1.60 X 0.80mm (inch : 0603)

Thickness Max.	Rated Voltage	Capacitance	Capacitance Tolerance	Part Number	Remark	Thickness Max.	Rated Voltage	Capacitance	Capacitance Tolerance	Part Number	Remark
0.90mm	25Vdc	15nF	±5%	CL10B153JA8NNN□		0.90mm	50Vdc	1.4nF	±5%	CL10B142JB8NNN□	
		15nF	±10%	CL10B153KA8NNN□				1.5nF	±5%	CL10B152JB8NNN□	
		18nF	±10%	CL10B183KA8NNN□				1.5nF	±10%	CL10B152KB8NNN□	
		18nF	±20%	CL10B183MA8NNN□				1.8nF	±5%	CL10B182JB8NNN□	
		22nF	±5%	CL10B223JA8NNN□				1.8nF	±10%	CL10B182KB8NNN□	
		22nF	±10%	CL10B223KA8NNN□				2.0nF	±10%	CL10B202KB8NNN□	
		27nF	±10%	CL10B273KA8NNN□				2.2nF	±5%	CL10B222JB8NNN□	
		33nF	±5%	CL10B333JA8NNN□				2.2nF	±10%	CL10B222KB8NNN□	
		33nF	±10%	CL10B333KA8NNN□				2.2nF	±20%	CL10B222MB8NNN□	
		39nF	±10%	CL10B393KA8NNN□				2.4nF	±10%	CL10B242KB8NNN□	
		47nF	±10%	CL10B473KA8NNN□				2.7nF	±5%	CL10B272JB8NNN□	
		56nF	±5%	CL10B563JA8NNN□				2.7nF	±10%	CL10B272KB8NNN□	
		56nF	±10%	CL10B563KA8NNN□				2.9nF	±10%	CL10B292KB8NNN□	
		68nF	±10%	CL10B683KA8NNN□				3.0nF	±10%	CL10B302KB8NNN□	
		82nF	±10%	CL10B823KA8NNN□				3.0nF	±20%	CL10B302MB8NNN□	
		100nF	±5%	CL10B104JA8NNN□				3.3nF	±5%	CL10B332JB8NNN□	
		100nF	±10%	CL10B104KA8NNN□				3.3nF	±10%	CL10B332KB8NNN□	
		100nF	±20%	CL10B104MA8NNN□				3.3nF	±20%	CL10B332MB8NNN□	
		150nF	±10%	CL10B154KA8NNN□				3.6nF	±5%	CL10B362JB8NNN□	
		220nF	±10%	CL10B224KA8NNN□				3.6nF	±10%	CL10B362KB8NNN□	
470nF	±10%	CL10B474KA8NNN□		3.9nF	±10%	CL10B392KB8NNN□					
1.0uF	±10%	CL10B105KA8NNN□		4.7nF	±5%	CL10B472JB8NNN□					
50Vdc	50Vdc	100pF	±10%	CL10B101KB8NNN□		4.7nF	±10%	CL10B472KB8NNN□			
		120pF	±10%	CL10B121KB8NNN□		4.7nF	±20%	CL10B472MB8NNN□			
		150pF	±10%	CL10B151KB8NNN□		5.1nF	±10%	CL10B512KB8NNN□			
		180pF	±10%	CL10B181KB8NNN□		5.6nF	±5%	CL10B562JB8NNN□			
		200pF	±10%	CL10B201KB8NNN□		5.6nF	±10%	CL10B562KB8NNN□			
		220pF	±5%	CL10B221JB8NNN□		5.6nF	±20%	CL10B562MB8NNN□			
		220pF	±10%	CL10B221KB8NNN□		6.2nF	±5%	CL10B622JB8NNN□			
		270pF	±5%	CL10B271JB8NNN□		6.2nF	±10%	CL10B622KB8NNN□			
		270pF	±10%	CL10B271KB8NNN□		6.8nF	±5%	CL10B682JB8NNN□			
		300pF	±10%	CL10B301KB8NNN□		6.8nF	±10%	CL10B682KB8NNN□			
		330pF	±5%	CL10B331JB8NNN□		6.8nF	±20%	CL10B682MB8NNN□			
		330pF	±10%	CL10B331KB8NNN□		7.5nF	±5%	CL10B752JB8NNN□			
		360pF	±10%	CL10B361KB8NNN□		8.2nF	±5%	CL10B822JB8NNN□			
		390pF	±10%	CL10B391KB8NNN□		8.2nF	±10%	CL10B822KB8NNN□			
		430pF	±10%	CL10B431KB8NNN□		9.1nF	±5%	CL10B912JB8NNN□			
		470pF	±5%	CL10B471JB8NNN□		10nF	±5%	CL10B103JB8NNN□			
		470pF	±10%	CL10B471KB8NNN□		10nF	±10%	CL10B103KB8NNN□			
		500pF	±10%	CL10B501KB8NNN□		10nF	±20%	CL10B103MB8NNN□			
		510pF	±10%	CL10B511KB8NNN□		12nF	±5%	CL10B123JB8NNN□			
		560pF	±5%	CL10B561JB8NNN□		12nF	±10%	CL10B123KB8NNN□			
		560pF	±10%	CL10B561KB8NNN□		15nF	±5%	CL10B153JB8NNN□			
		620pF	±5%	CL10B621JB8NNN□		15nF	±10%	CL10B153KB8NNN□			
		680pF	±5%	CL10B681JB8NNN□		15nF	±20%	CL10B153MB8NNN□			
		680pF	±10%	CL10B681KB8NNN□		18nF	±5%	CL10B183JB8NNN□			
		750pF	±10%	CL10B751KB8NNN□		18nF	±10%	CL10B183KB8NNN□			
		820pF	±5%	CL10B821JB8NNN□		20nF	±10%	CL10B203KB8NNN□			
		820pF	±10%	CL10B821KB8NNN□		22nF	±5%	CL10B223JB8NNN□			
		910pF	±5%	CL10B911JB8NNN□		22nF	±10%	CL10B223KB8NNN□			
		1.0nF	±10%	CL10B102KB8NNN□		22nF	±20%	CL10B223MB8NNN□			
		1.0nF	±20%	CL10B102MB8NNN□		27nF	±10%	CL10B273KB8NNN□			
		1.2nF	±5%	CL10B122JB8NNN□		33nF	±5%	CL10B333JB8NNN□			
		1.2nF	±10%	CL10B122KB8NNN□		33nF	±10%	CL10B333KB8NNN□			

※ □ mark means packaging code. If you want to learn the code or quantity in detail, please see p.148
 In order to move to the page directly, please click the here. ↑

Product Line Up (X7R)

■ Size : 1.60 X 0.80mm (inch : 0603)

Thickness Max.	Rated Voltage	Capacitance	Capacitance Tolerance	Part Number	Remark	Thickness Max.	Rated Voltage	Capacitance	Capacitance Tolerance	Part Number	Remark
0.90mm	50Vdc	39nF	±5%	CL10B393JB8NNN□		0.75mm	25Vdc	68nF	±10%	CL21B683KAANNN□	
		39nF	±10%	CL10B393KB8NNN□			50Vdc	18pF	±5%	CL21B180JBANNN□	
		47nF	±5%	CL10B473JB8NNN□				22pF	±5%	CL21B220JBANNN□	
		47nF	±10%	CL10B473KB8NNN□				56pF	±5%	CL21B560JBANNN□	
		47nF	±20%	CL10B473MB8NNN□				100pF	±5%	CL21B101JBANNN□	
		56nF	±5%	CL10B563JB8NNN□				100pF	±10%	CL21B101KBANNN□	
		56nF	±10%	CL10B563KB8NNN□				150pF	±10%	CL21B151KBANNN□	
		68nF	±5%	CL10B683JB8NNN□				180pF	±10%	CL21B181KBANNN□	
		68nF	±10%	CL10B683KB8NNN□				200pF	±10%	CL21B201KBANNN□	
		82nF	±5%	CL10B823JB8NNN□				220pF	±5%	CL21B221JBANNN□	
		82nF	±10%	CL10B823KB8NNN□				220pF	±10%	CL21B221KBANNN□	
		100nF	±5%	CL10B104JB8NNN□				270pF	±10%	CL21B271KBANNN□	
		100nF	±10%	CL10B104KB8NNN□				300pF	±10%	CL21B301KBANNN□	
		100nF	±20%	CL10B104MB8NNN□				330pF	±5%	CL21B331JBANNN□	
		220nF	±10%	CL10B224KB8NNN□				330pF	±10%	CL21B331KBANNN□	
		330nF	±10%	CL10B334KB8NNN□				360pF	±10%	CL21B361KBANNN□	
					390pF			±5%	CL21B391JBANNN□		
					390pF			±10%	CL21B391KBANNN□		
					470pF			±5%	CL21B471JBANNN□		
					470pF			±10%	CL21B471KBANNN□		
					500pF			±10%	CL21B501KBANNN□		
					510pF			±10%	CL21B511KBANNN□		
					560pF			±5%	CL21B561JBANNN□		
					560pF			±10%	CL21B561KBANNN□		
					620pF			±10%	CL21B621KBANNN□		
					680pF			±5%	CL21B681JBANNN□		
					680pF			±10%	CL21B681KBANNN□		
					750pF			±10%	CL21B751KBANNN□		
					820pF			±10%	CL21B821KBANNN□		
					910pF			±10%	CL21B911KBANNN□		
					1.0nF			±5%	CL21B102JBANNN□		
					1.0nF			±10%	CL21B102KBANNN□		
					1.0nF			±20%	CL21B102MBANNN□		
					1.2nF			±10%	CL21B122KBANNN□		
					1.3nF	±5%		CL21B132JBANNN□			
					1.5nF	±5%	CL21B152JBANNN□				
					1.5nF	±10%	CL21B152KBANNN□				
					1.8nF	±5%	CL21B182JBANNN□				
					1.8nF	±10%	CL21B182KBANNN□				
					2.0nF	±5%	CL21B202JBANNN□				
					2.0nF	±10%	CL21B202KBANNN□				
					2.2nF	±5%	CL21B222JBANNN□				
					2.2nF	±10%	CL21B222KBANNN□				
					2.2nF	±20%	CL21B222MBANNN□				
					2.4nF	±10%	CL21B242KBANNN□				
					2.4nF	±20%	CL21B242MBANNN□				
					2.7nF	±5%	CL21B272JBANNN□				
					2.7nF	±10%	CL21B272KBANNN□				
					3.0nF	±5%	CL21B302JBANNN□				
					3.0nF	±20%	CL21B302MBANNN□				
					3.3nF	±5%	CL21B332JBANNN□				
					3.3nF	±10%	CL21B332KBANNN□				
					3.6nF	±10%	CL21B362KBANNN□				
					3.9nF	±5%	CL21B392JBANNN□				

■ Size : 2.00 X 1.25mm (inch : 0805)

Thickness Max.	Rated Voltage	Capacitance	Capacitance Tolerance	Part Number	Remark	
0.75mm	16Vdc	15nF	±10%	CL21B153KOANNN□		
		22nF	±10%	CL21B223KOANNN□		
		33nF	±10%	CL21B333KOANNN□		
		39nF	±10%	CL21B393KOANNN□		
		47nF	±10%	CL21B473KOANNN□		
		56nF	±10%	CL21B563KOANNN□		
		68nF	±10%	CL21B683KOANNN□		
		100nF	±5%	CL21B104JOANNN□		
		100nF	±10%	CL21B104KOANNN□		
		100nF	±20%	CL21B104MOANNN□		
		120nF	±5%	CL21B124JOANNN□		
		150nF	±10%	CL21B154KOANNN□		
		180nF	±10%	CL21B184KOANNN□		
		25Vdc	220pF	±20%	CL21B221MAANNN□	
			1.0nF	±10%	CL21B102KAANNN□	
			1.0nF	±20%	CL21B102MAANNN□	
			2.2nF	±10%	CL21B222KAANNN□	
			2.2nF	±20%	CL21B222MAANNN□	
	4.7nF		±10%	CL21B472KAANNN□		
	5.6nF		±10%	CL21B562KAANNN□		
	6.8nF		±10%	CL21B682KAANNN□		
	6.8nF		±20%	CL21B682MAANNN□		
	10nF		±10%	CL21B103KAANNN□		
	12nF		±10%	CL21B123KAANNN□		
	15nF		±5%	CL21B153JAANNN□		
	15nF		±10%	CL21B153KAANNN□		
	18nF		±10%	CL21B183KAANNN□		
	22nF		±10%	CL21B223KAANNN□		
	27nF		±10%	CL21B273KAANNN□		
	33nF		±10%	CL21B333KAANNN□		
	39nF		±10%	CL21B393KAANNN□		
	47nF		±10%	CL21B473KAANNN□		
	56nF		±10%	CL21B563KAANNN□		

※ □ mark means packaging code. If you want to learn the code or quantity in detail, please see p.148

In order to move to the page directly, please click the here. ↑

Standard & High Capacitors

Product Line Up (X7R)

■ Size : 2.00 X 1.25mm (inch : 0805)

Thickness Max.	Rated Voltage	Capacitance	Capacitance Tolerance	Part Number	Remark	Thickness Max.	Rated Voltage	Capacitance	Capacitance Tolerance	Part Number	Remark			
0.75mm	50Vdc	3.9nF	±10%	CL21B392KBANNN□		0.95mm	50Vdc	2.7nF	±10%	CL21B272KBCNNN□				
		4.7nF	±5%	CL21B472JBANNN□				3.3nF	±10%	CL21B332KBCNNN□				
		4.7nF	±10%	CL21B472KBANNN□				4.7nF	±5%	CL21B472JBCNNN□				
		5.0nF	±10%	CL21B502KBANNN□				6.8nF	±10%	CL21B682KBCNNN□				
		5.1nF	±10%	CL21B512KBANNN□				10nF	±5%	CL21B103JBCNNN□				
		5.6nF	±5%	CL21B562JBANNN□				10nF	±10%	CL21B103KBCNNN□				
		5.6nF	±10%	CL21B562KBANNN□				18nF	±5%	CL21B183JBCNNN□				
		6.8nF	±5%	CL21B682JBANNN□				22nF	±10%	CL21B223KBCNNN□				
		6.8nF	±10%	CL21B682KBANNN□				24nF	±5%	CL21B243JBCNNN□				
		7.5nF	±10%	CL21B752KBANNN□				33nF	±5%	CL21B333JBCNNN□				
		8.2nF	±5%	CL21B822JBANNN□				39nF	±5%	CL21B393JBCNNN□				
		8.2nF	±10%	CL21B822KBANNN□				39nF	±10%	CL21B393KBCNNN□				
		9.1nF	±10%	CL21B912KBANNN□				47nF	±5%	CL21B473JBCNNN□				
		10nF	±5%	CL21B103JBANNN□				47nF	±10%	CL21B473KBCNNN□				
		10nF	±10%	CL21B103KBANNN□				47nF	±20%	CL21B473MBCNNN□				
		10nF	±20%	CL21B103MBANNN□				51nF	±10%	CL21B513KBCNNN□				
		12nF	±5%	CL21B123JBANNN□				56nF	±5%	CL21B563JBCNNN□				
		12nF	±10%	CL21B123KBANNN□				56nF	±10%	CL21B563KBCNNN□				
		12nF	±20%	CL21B123MBANNN□				68nF	±5%	CL21B683JBCNNN□				
		15nF	±5%	CL21B153JBANNN□				68nF	±10%	CL21B683KBCNNN□				
		15nF	±10%	CL21B153KBANNN□				82nF	±5%	CL21B823JBCNNN□				
		15nF	±20%	CL21B153MBANNN□				82nF	±10%	CL21B823KBCNNN□				
		18nF	±10%	CL21B183KBANNN□				100nF	±5%	CL21B104JBCNNN□				
		20nF	±10%	CL21B203KBANNN□				100nF	±10%	CL21B104KBCNNN□				
		22nF	±5%	CL21B223JBANNN□				100nF	±20%	CL21B104MBCNNN□				
		22nF	±10%	CL21B223KBANNN□				1.35mm	6.3Vdc	1.0uF	±10%	CL21B105KQFNNN□		
		27nF	±5%	CL21B273JBANNN□						2.2uF	±5%	CL21B225JQFNNN□		
		27nF	±10%	CL21B273KBANNN□						2.2uF	±10%	CL21B225KQFNNN□		
		33nF	±5%	CL21B333JBANNN□						3.3uF	±10%	CL21B335KQFNNN□		
		33nF	±10%	CL21B333KBANNN□						3.3uF	±20%	CL21B335MQFNNN□		
		33nF	±20%	CL21B333MBANNN□						4.7uF	±10%	CL21B475KQFNNN□	Ref.	
		39nF	±5%	CL21B393JBANNN□						10Vdc	470nF	±10%	CL21B474KPFNNN□	
		39nF	±10%	CL21B393KBANNN□							680nF	±10%	CL21B684KPFNNN□	
47nF	±10%	CL21B473KBANNN□		820nF	±10%	CL21B824KPFNNN□								
0.95mm	16Vdc	150nF	±10%	CL21B154KOCNNN□		1.0uF	±5%				CL21B105JPFNNN□			
		220nF	±5%	CL21B224JOCNNN□		1.0uF	±10%				CL21B105KPFNNN□			
		220nF	±10%	CL21B224KOCNNN□		1.0uF	±20%				CL21B105MPFNNN□			
		220nF	±20%	CL21B224MOCNNN□		2.2uF	±10%			CL21B225KPFNNN□				
		270nF	±5%	CL21B274JOCNNN□		2.2uF	±20%			CL21B225MPFNNN□				
		270nF	±10%	CL21B274KOCNNN□		3.3uF	±10%			CL21B335KPFNNN□				
		330nF	±5%	CL21B334JOCNNN□		4.7uF	±10%	CL21B475KPFNNN□	Ref.					
		330nF	±10%	CL21B334KOCNNN□		16Vdc	150nF	±10%	CL21B154KOFNNN□					
		1.0uF	±10%	CL21B105KOCNNN□			220nF	±10%	CL21B224KOFNNN□					
		25Vdc	47nF	±10%	CL21B473KACNNN□			330nF	±10%	CL21B334KOFNNN□				
			68nF	±10%	CL21B683KACNNN□			390nF	±10%	CL21B394KOFNNN□				
			82nF	±10%	CL21B823KACNNN□			470nF	±5%	CL21B474JOFNNN□				
			100nF	±5%	CL21B104JACNNN□			470nF	±10%	CL21B474KOFNNN□				
			100nF	±10%	CL21B104KACNNN□			470nF	±20%	CL21B474MOFNNN□				
			100nF	±20%	CL21B104MACNNN□			680nF	±5%	CL21B684JOFNNN□				
50Vdc	120nF	±5%	CL21B124JACNNN□		680nF		±10%	CL21B684KOFNNN□						
	120nF	±10%	CL21B124KACNNN□		1.0uF		±10%	CL21B105KOFNNN□						
	150nF	±10%	CL21B154KACNNN□		2.2uF		±10%	CL21B225KOFNNN□						
	1.0nF	±10%	CL21B102KBCNNN□		2.2uF		±20%	CL21B225MOFNNN□						
	2.2nF	±10%	CL21B222KBCNNN□		4.7uF	±10%	CL21B475KOFNNN□	Ref.						

※ □ mark means packaging code. If you want to learn the code or quantity in detail, please see p.148

In order to move to the page directly, please click the here. ↑

Product Line Up (X7R)

■ Size : 2.00 X 1.25mm (inch : 0805)

Thickness Max.	Rated Voltage	Capacitance	Capacitance Tolerance	Part Number	Remark	Thickness Max.	Rated Voltage	Capacitance	Capacitance Tolerance	Part Number	Remark		
1.35mm	25Vdc	18nF	±10%	CL21B183KAFNNN□		1.00mm	16Vdc	270nF	±20%	CL31B274MOCNNN□			
		47nF	±10%	CL21B473KAFNNN□				330nF	±10%	CL31B334KOCNNN□			
		100nF	±10%	CL21B104KAFNNN□				330nF	±20%	CL31B334MOCNNN□			
		150nF	±10%	CL21B154KAFNNN□				390nF	±10%	CL31B394KOCNNN□			
		180nF	±10%	CL21B184KAFNNN□				470nF	±10%	CL31B474KOCNNN□			
		220nF	±5%	CL21B224JAFNNN□				560nF	±10%	CL31B564KOCNNN□			
		220nF	±10%	CL21B224KAFNNN□				680nF	±10%	CL31B684KOCNNN□			
		220nF	±20%	CL21B224MAFNNN□				25Vdc	4.7nF	±10%	CL31B472KACNNN□		
		270nF	±10%	CL21B274KAFNNN□					22nF	±10%	CL31B223KACNNN□		
		330nF	±10%	CL21B334KAFNNN□					47nF	±10%	CL31B473KACNNN□		
		390nF	±10%	CL21B394KAFNNN□					68nF	±10%	CL31B683KACNNN□		
		470nF	±5%	CL21B474JAFNNN□					100nF	±10%	CL31B104KACNNN□		
		470nF	±10%	CL21B474KAFNNN□					120nF	±10%	CL31B124KACNNN□		
		1.0uF	±10%	CL21B105KAFNNN□					150nF	±10%	CL31B154KACNNN□		
		1.5uF	±10%	CL21B155KAFNNN□					180nF	±10%	CL31B184KACNNN□		
		2.2uF	±10%	CL21B225KAFNNN□					220nF	±5%	CL31B224JACNNN□		
		4.7uF	±10%	CL21B475KAFNNN□	Ref.				220nF	±10%	CL31B224KACNNN□		
		35Vdc	1.0uF	±10%	CL21B105KLFNNN□					270nF	±10%	CL31B274KACNNN□	
	50Vdc		560pF	±10%	CL21B561KBFNNN□				330nF	±10%	CL31B334KACNNN□		
			47nF	±10%	CL21B473KBFNNN□				390nF	±10%	CL31B394KACNNN□		
			68nF	±5%	CL21B683JBFNNN□				50Vdc	120pF	±10%	CL31B121KBCNNN□	
			68nF	±10%	CL21B683KBFNNN□					180pF	±10%	CL31B181KBCNNN□	
			75nF	±10%	CL21B753KBFNNN□					220pF	±10%	CL31B221KBCNNN□	
			82nF	±10%	CL21B823KBFNNN□					270pF	±10%	CL31B271KBCNNN□	
			100nF	±5%	CL21B104JBFNNN□					330pF	±10%	CL31B331KBCNNN□	
			100nF	±10%	CL21B104KBFNNN□			390pF		±5%	CL31B391JBCNNN□		
			100nF	±20%	CL21B104MBFNNN□			390pF		±10%	CL31B391KBCNNN□		
			120nF	±10%	CL21B124KBFNNN□			470pF		±10%	CL31B471KBCNNN□		
			150nF	±10%	CL21B154KBFNNN□			560pF		±10%	CL31B561KBCNNN□		
			220nF	±5%	CL21B224JBFNNN□			680pF		±10%	CL31B681KBCNNN□		
			220nF	±10%	CL21B224KBFNNN□			820pF		±10%	CL31B821KBCNNN□		
			270nF	±10%	CL21B274KBFNNN□			1.0nF		±5%	CL31B102KBCNNN□		
			330nF	±10%	CL21B334KBFNNN□			1.0nF		±10%	CL31B102KBCNNN□		
			470nF	±10%	CL21B474KBFNNN□			1.0nF		±20%	CL31B102MBCNNN□		
			680nF	±10%	CL21B684KBFNNN□			1.2nF		±10%	CL31B122KBCNNN□		
			1.0uF	±10%	CL21B105KBFNNN□			1.5nF		±5%	CL31B152JBCNNN□		
			1.0uF	±20%	CL21B105MBFNNN□		1.5nF	±10%		CL31B152KBCNNN□			
			1.40mm	6.3Vdc	4.7uF	±10%	CL21B475KQNNN□	Ref.		1.8nF	±10%	CL31B182KBCNNN□	
					10uF	±10%	CL21B106KQNNN□		2.0nF	±10%	CL31B202KBCNNN□		
				10Vdc	4.7uF	±10%	CL21B475KPQNNN□	Ref.	2.2nF	±10%	CL31B222KBCNNN□		
					10uF	±10%	CL21B106KPQNNN□		2.4nF	±10%	CL31B242KBCNNN□		
		16Vdc			10uF	±10%	CL21B106KQNNN□		3.0nF	±10%	CL31B302KBCNNN□		
10uF	±10%				CL21B106KQNNN□		3.3nF	±5%	CL31B332JBCNNN□				

■ Size : 3.20 X 1.60mm (inch : 1206)

Thickness Max.	Rated Voltage	Capacitance	Capacitance Tolerance	Part Number	Remark
1.00mm	10Vdc	1.0uF	±10%	CL31B105KPCNNN□	
		1.2uF	±10%	CL31B125KPCNNN□	
	16Vdc	22nF	±5%	CL31B223JOCNNN□	
		100nF	±10%	CL31B104KOCNNN□	
		220nF	±10%	CL31B224KOCNNN□	
		270nF	±10%	CL31B274KOCNNN□	

* □ mark means packaging code. If you want to learn the code or quantity in detail, please see p.148
 In order to move to the page directly, please click the here. ↑

Standard & High Capacitors

Product Line Up (X7R)

■ Size : 3.20 X 1.60mm (inch : 1206)

Thickness Max.	Rated Voltage	Capacitance	Capacitance Tolerance	Part Number	Remark	Thickness Max.	Rated Voltage	Capacitance	Capacitance Tolerance	Part Number	Remark	
1.00mm	50Vdc	10nF	±5%	CL31B103JBCNNN □		1.80mm	6.3Vdc	10uF	±10%	CL31B106KQHNNN □		
		10nF	±10%	CL31B103KBCNNN □				10uF	±20%	CL31B106MQHNNN □		
		10nF	±20%	CL31B103MBCNNN □				10Vdc	22uF	±10%	CL31B226KQHNNN □	
		15nF	±5%	CL31B153JBCNNN □					4.7uF	±10%	CL31B475KPHNNN □	
		15nF	±10%	CL31B153KBCNNN □					6.8uF	+80/-20%	CL31B685ZPHNNN □	
		18nF	±10%	CL31B183KBCNNN □					10uF	±10%	CL31B106KPHNNN □	
		22nF	±5%	CL31B223JBCNNN □			22uF		±10%	CL31B226KPHNNN □		
		22nF	±10%	CL31B223KBCNNN □			22uF		±20%	CL31B226MPHNNN □		
		27nF	±5%	CL31B273JBCNNN □			16Vdc	1.0uF	±20%	CL31B105MOHNNN □		
		27nF	±10%	CL31B273KBCNNN □				2.2uF	±10%	CL31B225KOHNNN □		
		33nF	±5%	CL31B333JBCNNN □				2.2uF	±20%	CL31B225MOHNNN □		
		33nF	±10%	CL31B333KBCNNN □				3.3uF	±10%	CL31B335KOHNNN □		
		39nF	±5%	CL31B393JBCNNN □				4.7uF	±10%	CL31B475KOHNNN □		
		39nF	±10%	CL31B393KBCNNN □				10uF	±10%	CL31B106KOHNNN □		
		47nF	±5%	CL31B473JBCNNN □			25Vdc	10uF	±20%	CL31B106MOHNNN □		
		47nF	±10%	CL31B473KBCNNN □				680nF	±10%	CL31B684KAHNNN □		
		56nF	±5%	CL31B563JBCNNN □				1.0uF	±5%	CL31B105JAHNNN □		
		56nF	±10%	CL31B563KBCNNN □				1.0uF	±10%	CL31B105KAHNNN □		
		68nF	±10%	CL31B683KBCNNN □				1.0uF	±20%	CL31B105MAHNNN □		
		82nF	±10%	CL31B823KBCNNN □				1.2uF	±20%	CL31B125MAHNNN □		
		100nF	±5%	CL31B104JBCNNN □				2.2uF	±10%	CL31B225KAHNNN □		
		100nF	±10%	CL31B104KBCNNN □				2.2uF	±20%	CL31B225MAHNNN □		
		100nF	±20%	CL31B104MBCNNN □				4.7uF	±10%	CL31B475KAHNNN □		
		120nF	±10%	CL31B124KBCNNN □				4.7uF	±20%	CL31B475MAHNNN □		
150nF	±10%	CL31B154KBCNNN □		10uF	±10%	CL31B106KAHNNN □						
220nF	±10%	CL31B224KBCNNN □		35Vdc	10uF	±10%		CL31B106KLHNNN □	Ref.			
4.7uF	±10%	CL31B475KOELENN □			50Vdc	4.7nF	±10%	CL31B472KBHNNN □				
2.2uF	±10%	CL31B225KPENNN □		390nF		±10%	CL31B394KBHNNN □					
2.2uF	±20%	CL31B225MPENNN □		470nF		±5%	CL31B474JBHNNN □					
1.0uF	±10%	CL31B105KAPLNN □		470nF		±10%	CL31B474KBHNNN □					
1.5uF	±10%	CL31B155KPFNNN □		680nF		±10%	CL31B684KBHNNN □					
2.2uF	±10%	CL31B225KPFNNN □		1.0uF		±10%	CL31B105KBHNNN □					
2.2uF	±20%	CL31B225MPFNNN □		2.2uF		±10%	CL31B225KBHNNN □					
820nF	±10%	CL31B824KOFNNN □		4.7uF		±10%	CL31B475KBHNNN □					
1.0uF	±5%	CL31B105JOFNNN □		10uF		±10%	CL31B106KBHNNN □	Ref.				
1.0uF	±10%	CL31B105KOFNNN □										
1.0uF	±20%	CL31B105MOFNNN □										
1.5uF	±10%	CL31B155KOFNNN □										
1.40mm	10Vdc	1.5uF	±10%	CL31B155KPFNNN □								
		2.2uF	±10%	CL31B225KPFNNN □								
		2.2uF	±20%	CL31B225MPFNNN □								
	16Vdc	820nF	±10%	CL31B824KOFNNN □								
		1.0uF	±5%	CL31B105JOFNNN □								
		1.0uF	±10%	CL31B105KOFNNN □								
		1.0uF	±20%	CL31B105MOFNNN □								
		1.5uF	±10%	CL31B155KOFNNN □								
		10nF	±2%	CL31B103GAFNNN □								
	25Vdc	470nF	±5%	CL31B474JAFNNN □								
		470nF	±10%	CL31B474KAFNNN □								
		470nF	±20%	CL31B474MAFNNN □								
560nF		±10%	CL31B564KAFNNN □									
100nF		±10%	CL31B104KBFNNN □									
180nF		±10%	CL31B184KBFNNN □									
50Vdc	200nF	±10%	CL31B204KBFNNN □									
	220nF	±5%	CL31B224JBFNNN □									
	220nF	±10%	CL31B224KBFNNN □									
	220nF	±20%	CL31B224MBFNNN □									
	270nF	±10%	CL31B274KBFNNN □									
	330nF	±5%	CL31B334JBFNNN □									
	330nF	±10%	CL31B334KBFNNN □									
	330nF	±20%	CL31B334MBFNNN □									
1.80mm	6.3Vdc	3.3uF	±10%	CL31B335KQHNNN □								
		6.8uF	±10%	CL31B685KQHNNN □								

※ □ mark means packaging code. If you want to learn the code or quantity in detail, please see p.148

In order to move to the page directly, please click the here. ↑

Product Line Up (X7R)

■ Size : 3.20 X 2.50mm (inch : 1210)

Thickness Max.	Rated Voltage	Capacitance	Capacitance Tolerance	Part Number	Remark	Thickness Max.	Rated Voltage	Capacitance	Capacitance Tolerance	Part Number	Remark
1.45mm	16Vdc	100nF	± 10%	CL32B104KOFNNN□		2.70mm	50Vdc	4.7uF	± 10%	CL32B475KBJNNN□	
		220nF	± 10%	CL32B224KOFNNN□				10uF	± 10%	CL32B106KBJNNN□	
		470nF	± 10%	CL32B474KOFNNN□							
		680nF	± 10%	CL32B684KOFNNN□							
		1.0uF	± 10%	CL32B105KOFNNN□							
		2.2uF	± 10%	CL32B225KOFNNN□							
	25Vdc	220nF	± 5%	CL32B224JAFNNN□							
		220nF	± 10%	CL32B224KAFNNN□							
		470nF	± 20%	CL32B474MAFNNN□							
		560nF	± 5%	CL32B564JAFNNN□							
		1.0uF	± 10%	CL32B105KAFNNN□							
	50Vdc	47nF	± 10%	CL32B473KBFNNN□							
		100nF	± 5%	CL32B104JBFNNN□							
		100nF	± 10%	CL32B104KBFNNN□							
		100nF	± 20%	CL32B104MBFNNN□							
		120nF	± 5%	CL32B124JBFNNN□							
		120nF	± 10%	CL32B124KBFNNN□							
		120nF	± 20%	CL32B124MBFNNN□							
		150nF	± 5%	CL32B154JBFNNN□							
		150nF	± 10%	CL32B154KBFNNN□							
		220nF	± 5%	CL32B224JBFNNN□							
		220nF	± 10%	CL32B224KBFNNN□							
		270nF	± 10%	CL32B274KBFNNN□							
		330nF	± 5%	CL32B334JBFNNN□							
		330nF	± 10%	CL32B334KBFNNN□							
		390nF	± 10%	CL32B394KBFNNN□							
		470nF	± 5%	CL32B474JBFNNN□							
		470nF	± 10%	CL32B474KBFNNN□							
1.80mm	16Vdc	3.3uF	± 10%	CL32B335KOHNNN□							
	25Vdc	330nF	± 10%	CL32B334KAHNNN□							
		2.2uF	± 10%	CL32B225KAHNNN□							
	50Vdc	820nF	± 10%	CL32B824KBHNNN□							
		1.0uF	± 10%	CL32B105KBHNNN□							
		1.0uF	± 20%	CL32B105MBHNNN□							
2.00mm	16Vdc	10uF	± 10%	CL32B106KOLN□							
	25Vdc	10uF	± 10%	CL32B106KAULN□							
	35Vdc	4.7uF	± 10%	CL32B475KLULN□							
		10uF	± 10%	CL32B106KLULN□							
2.20mm	10Vdc	4.7uF	± 10%	CL32B475KPINN□							
		10uF	± 10%	CL32B106KPINN□							
	16Vdc	4.7uF	± 10%	CL32B475KONN□							
	25Vdc	2.2uF	± 10%	CL32B225KAINN□							
2.70mm	6.3Vdc	22uF	± 20%	CL32B226MQJNN□							
		47uF	± 20%	CL32B476MQJNN□	Ref.						
	10Vdc	22uF	± 10%	CL32B226KPJNN□							
		47uF	± 20%	CL32B476MPJNN□	Ref.						
	16Vdc	10uF	± 10%	CL32B106KONN□							
		22uF	± 10%	CL32B226KONN□							
		22uF	± 20%	CL32B226MOJNN□							
	25Vdc	3.3uF	± 10%	CL32B335KAJNN□							
		10uF	± 10%	CL32B106KAJNN□							
		22uF	± 10%	CL32B226KAJNN□							
	35Vdc	10uF	± 10%	CL32B106KLJNN□							
50Vdc	2.2uF	± 10%	CL32B225KBJNN□								

※ □ mark means packaging code. If you want to learn the code or quantity in detail, please see p.148
In order to move to the page directly, please click the here. ↑

Low Profile Capacitors

Feature

- Decoupling and filtering application where the thickness is limited
- A range of low - profile products as thin as 0.11mm in 1005mm



Application

- Mobile phone
- Smart watch
- IC Package

Structure and Dimensions

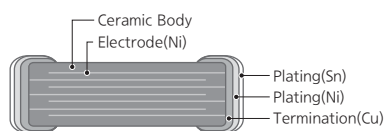
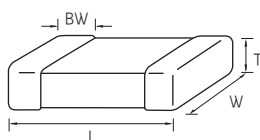

Size Code	EIA Code	Dimension(mm)				
		L	W	T	Thickness Code	BW
05	0402	1.00±0.05	0.50±0.05	0.0975±0.0125	L	0.25±0.075
		1.00±0.10	0.50±0.05	0.19±0.03	X	0.25±0.10
		1.00±0.05	0.50±0.05	0.30±0.03	3	
10	0603	1.60±0.10	0.80±0.10	0.50+0.0/-0.10	5	0.30±0.20
		1.60±0.10	0.80±0.10	0.60±0.10	6	
		1.60±0.10	0.80±0.10	0.70±0.10	7	
21	0805	2.00±0.10	1.25±0.10	0.60±0.10	6	0.50+0.20/-0.30
		2.00±0.10	1.25±0.10	0.70±0.10	7	
		2.00±0.10	1.25±0.10	0.80±0.10	8	
		2.00±0.10	1.25±0.10	0.85±0.10	9	
		2.00±0.10	1.25±0.10	1.10±0.10	E	
31	1206	3.20±0.20	1.60±0.20	0.85±0.10	C	0.50±0.30
		3.20±0.20	1.60±0.20	0.90±0.10	9	
		3.20±0.20	1.60±0.20	1.10±0.10	E	
		3.20±0.20	1.60±0.20	1.15±0.10	M	
32	1210	3.20±0.30	2.50±0.20	0.85±0.10	C	0.60±0.30
		3.20±0.30	2.50±0.20	0.90±0.10	9	
		3.20±0.30	2.50±0.20	1.15±0.10	M	
		3.20±0.30	2.50±0.20	1.35±0.15	S	
		3.20±0.30	2.50±0.20	1.60±0.10	T	
		3.20±0.30	2.50±0.20	1.80±0.20	U	
		3.20±0.30	2.50±0.20	2.00±0.20	I	

Low Profile Capacitance Table (X5R)

Size inch (mm)	T max. (mm)	Rated Voltage (Vdc)	Capacitance(uF)												
			0.22	0.47	1.0	2.2	4.7	10	22	47	68	100			
0402 (1005)	0.11	6.3	█												
	0.22	6.3		█											
	0.33	4.0			█										
		6.3				█									
0603 (1608)	0.50	4.0							█						
		6.3				█									
		10			█										
		16			█										
		25			█										
	0.60	6.3					█								
		0.80	6.3								█				
			10									█			
			16									█			
0805 (2012)	0.70	10				█									
		16			█										
	0.80	6.3							█						
		10							█						
	0.90	6.3									█				
	0.95	4.0									█				
		6.3			█										
		10			█										
		16			█										
		25			█										
		35						█							
	1.00	50			█										
		6.3										█			
50					█										
1.20	6.3									█					
1206 (3216)	0.95	6.3								█					
		10								█					
		16				█									
		25					█								
	1.00	35						█							
		50			█										
		100				█									
	1.20	16							█						
		1.25	10								█				
16											█				
25			█												

Low Profile Capacitors

Low Profile Capacitance Table (X5R)

Size inch (mm)	T max. (mm)	Rated Voltage (Vdc)	Capacitance(uF)												
			0.22	0.47	1.0	2.2	4.7	10	22	47	68	100			
1210 (3225)	0.95	16													
	1.00	25													
	1.25	16													
	1.50	10													
		25						6.8uF							
	1.70	16													
		25													
	2.00	25													
		35													
	2.20	10													
16															
25															

Low Profile Capacitance Table (X6S)

Size inch (mm)	T max. (mm)	Rated Voltage (Vdc)	Capacitance(uF)											
			0.22	0.47	1.0	2.2	4.7	10	22	47	68	100		
0402(1005)	0.33	6.3			X6S									
0805 (2012)	0.95	2.5								X6S				
		4.0							X6S					
		10							X6S					
1206(3216)	0.95	25					X6S							

Product Line Up (X5R)

■ Size : 1.00 X 0.50mm (inch : 0402)

Thickness Max.	Rated Voltage	Capacitance	Capacitance Tolerance	Part Number	Remark
0.11mm	6.3Vdc	220nF	±20%	CL05A224MQLHEC □	Derating Ref.
0.22mm	6.3Vdc	470nF	±20%	CL05A474MQXLNN □	Derating Ref.
		1.0uF	±20%	CL05A105MQXLNN □	Derating Ref.
0.33mm	4.0Vdc	2.2uF	±20%	CL05A225MR3LRN □	Derating Ref.
	6.3Vdc	1.0uF	±20%	CL05A105MQ3LNN □	Derating Ref.
		2.2uF	±20%	CL05A225MQ3LRN □	Derating Ref.
0.35mm	6.3Vdc	4.7uF	±20%	CL05A475MQ3LUN □	Derating Ref.

■ Size: 1.60 X 0.80mm (inch : 0603)

Thickness Max.	Rated Voltage	Capacitance	Capacitance Tolerance	Part Number	Remark
0.50mm	4.0Vdc	10uF	±20%	CL10A106MR5LQN □	Derating Ref.
		6.3Vdc	2.2uF	±10%	CL10A225KQ5LNN □
	4.7uF		±10%	CL10A475KQ5LNN □	
	4.7uF		±20%	CL10A475MQ5LNN □	
	10uF		±20%	CL10A106MQ5LRN □	Derating Ref.
	10Vdc	1.0uF	±10%	CL10A105KP5LNN □	
		2.2uF	±10%	CL10A225KP5LNN □	
		4.7uF	±10%	CL10A475KP5LNN □	Derating
		4.7uF	±20%	CL10A475MP5LNN □	Derating
	16Vdc	1.0uF	±10%	CL10A105KQ5LNN □	
		2.2uF	±10%	CL10A225KQ5LNN □	Derating
		2.2uF	±10%	CL10A225KA5LNN □	Derating
0.60mm	6.3Vdc	4.7uF	±10%	CL10A475KQ5NNN □	
		4.7uF	±20%	CL10A475MQ5NNN □	
0.80mm	6.3Vdc	22uF	±20%	CL10A226MP7LUN □	Derating
	10Vdc	22uF	±20%	CL10A226MP7LUN □	Derating
	16Vdc	22uF	±20%	CL10A226M07JZN □	Derating

■ Size : 2.00 X 1.25mm (inch : 0805)

Thickness Max.	Rated Voltage	Capacitance	Capacitance Tolerance	Part Number	Remark	
0.70mm	10Vdc	2.2uF	±10%	CL21A225KP6LNN □		
	16Vdc	1.0uF	±20%	CL21A105M06LNN □		
		2.2uF	±10%	CL21A225K06LNN □		
0.80mm	6.3Vdc	10uF	±10%	CL21A106KQ7LQN □		
		47uF	±20%	CL21A476MQ7FRN □	Derating	
		47uF	±20%	CL21A476MQ7LRN □	Derating	
	10Vdc	10uF	±10%	CL21A106KP7LQN □	Derating	
0.90mm	6.3Vdc	47uF	±20%	CL21A476MQ8LRN □	Derating	
0.95mm	4.0Vdc	22uF	±20%	CL21A226MRCLRN □	Derating	
		47uF	±20%	CL21A476MRCLRP □	Derating	
	6.3Vdc	1.0uF	±10%	CL21A105KQCLNN □		
		1.0uF	±10%	CL21A105KQCNNN □		
		4.7uF	±10%	CL21A475KQCLNN □		
		4.7uF	±20%	CL21A475MQCLNN □		
		10uF	±10%	CL21A106KQCLRN □		
		10uF	±20%	CL21A106MQCLNN □		
		22uF	±10%	CL21A226KQCLRN □	Derating	
		22uF	±20%	CL21A226MQCLQN □	Derating	
		22uF	±20%	CL21A226MQCLRN □	Derating	
		47uF	±20%	CL21A476MQCLRN □	Derating	
		10Vdc	2.2uF	±10%	CL21A225KPCLNN □	
			4.7uF	±10%	CL21A475KPCLNN □	
	4.7uF		±20%	CL21A475MPCLNN □		
	10uF		±10%	CL21A106KPCLNN □	Derating	
	10uF		±10%	CL21A106KPCLQN □	Derating	
	10uF		±20%	CL21A106MPCLNN □	Derating	
	10uF		±20%	CL21A106MPCLQN □	Derating	
	22uF		±10%	CL21A226KPCLRN □	Derating	
	22uF		±20%	CL21A226MPCLRN □	Derating	
	22uF		+80/-20%	CL21A226ZPCLRN □	Derating	
	16Vdc		2.2uF	±10%	CL21A225KQCLNN □	
			4.7uF	±10%	CL21A475KQCLNN □	
		4.7uF	±10%	CL21A475KQCLRN □		
		10uF	±10%	CL21A106KQCLNN □	Derating	
		10uF	±10%	CL21A106KQCLRN □	Derating	
10uF		±10%	CL21A106KQCLSN □	Derating		
22uF		±20%	CL21A226MOCLRN □	Derating		
25Vdc		1.0uF	±10%	CL21A105KACLNN □		
		1.0uF	±10%	CL21A105KACNNN □		
		2.2uF	±10%	CL21A225KACLNN □	Derating	
		4.7uF	±10%	CL21A475KACLNN □	Derating	
35Vdc		10uF	±10%	CL21A106KACLRN □	Derating	
	50Vdc	4.7uF	±10%	CL21A475KLCLQN □	Derating	
		1.0uF	±10%	CL21A105KBCFNN □		
1.00mm	6.3Vdc	33uF	±20%	CL21A336MQ9LRN □	Derating	
		47uF	±20%	CL21A476MQ9LRN □	Derating	
1.20mm	6.3Vdc	2.2uF	±10%	CL21A225KB9LNN □	Derating	
		33uF	±20%	CL21A336MQELRN □	Derating	

※ □ mark means packaging code. If you want to learn the code or quantity in detail, please see p.148
In order to move to the page directly, please click the here. ↑

Low Profile Capacitors

Product Line Up (X5R)

■ Size : 3.20 X 1.60mm (inch : 1206)

Thickness Max.	Rated Voltage	Capacitance	Capacitance Tolerance	Part Number	Remark
0.95mm	6.3Vdc	10uF	±20%	CL31A106MQCLNN□	
		22uF	±10%	CL31A226KQCLNN□	Derating
		22uF	±20%	CL31A226MQCLNN□	Derating
	10Vdc	10uF	±10%	CL31A106KPCLNN□	
		10uF	±20%	CL31A106MPCLNN□	
	16Vdc	2.2uF	±10%	CL31A225KOCLNN□	
		4.7uF	±10%	CL31A475KOCLNN□	
		4.7uF	±20%	CL31A475MOCLNN□	
		10uF	±10%	CL31A106KOCLNN□	
		22uF	±10%	CL31A226KOCLNN□	Derating
		22uF	±20%	CL31A226MOCLNN□	Derating
	25Vdc	4.7uF	±10%	CL31A475KACLNN□	
10uF		±10%	CL31A106KACLNN□	Derating	
1.00mm	35Vdc	4.7uF	±10%	CL31A475KL9LNN□	Derating
	50Vdc	1.0uF	±10%	CL31A105KB9LNN□	
		2.2uF	±10%	CL31A225KB9LNN□	
	4.7uF	±10%	CL31A475KB9LNN□	Derating	
100Vdc	2.2uF	±10%	CL31A225KC9LNN□	Derating	
1.20mm	16Vdc	4.7uF	±10%	CL31A475KOELNN□	
1.25mm	10Vdc	10uF	±10%	CL31A106KPPLNN□	
		10uF	±20%	CL31A106MPPLNN□	
	16Vdc	4.7uF	±10%	CL31A475KOPLNN□	
		4.7uF	±20%	CL31A475MOPLNN□	
	25Vdc	1.0uF	±10%	CL31A105KAPLNN□	
		2.2uF	±10%	CL31A225KAPLNN□	
4.7uF	±10%	CL31A475KAPLNN□			

■ Size : 3.20 X 2.50mm (inch : 1210)

Thickness Max.	Rated Voltage	Capacitance	Capacitance Tolerance	Part Number	Remark
0.95mm	16Vdc	10uF	±10%	CL32A106KOCLNN□	
		22uF	±20%	CL32A226MOCLNN□	Derating
1.00mm	25Vdc	10uF	±10%	CL32A106KA9LNN□	
1.25mm	16Vdc	10uF	±10%	CL32A106KOMLNN□	
1.50mm	10Vdc	22uF	±10%	CL32A226KPSLNN□	
		22uF	±20%	CL32A226MPSLNN□	
	25Vdc	6.8uF	±10%	CL32A685KASLNN□	
1.70mm	16Vdc	22uF	±10%	CL32A226KOTFNN□	Derating
		22uF	±20%	CL32A226MOTLNN□	Derating
	25Vdc	10uF	±10%	CL32A106KATLNN□	
		10uF	±20%	CL32A106MATLNN□	
2.00mm	25Vdc	4.7uF	±10%	CL32A475KAULNN□	
		10uF	±10%	CL32A106KAULNN□	
	35Vdc	4.7uF	±10%	CL32A475KLULNN□	
		10uF	±10%	CL32A106KLULNN□	
2.20mm	10Vdc	10uF	±10%	CL32A106KPINNN□	
		10uF	±10%	CL32A106KOILNN□	
	25Vdc	2.2uF	±20%	CL32A225MAINNN□	
		4.7uF	±10%	CL32A475KAINNN□	
		10uF	±10%	CL32A106KAILNN□	
		10uF	±20%	CL32A106MAILNN□	

Product Line Up (X6S)

■ Size : 1.00 X 0.50mm (inch : 0402)

Thickness Max.	Rated Voltage	Capacitance	Capacitance Tolerance	Part Number	Remark
0.33mm	6.3Vdc	1.0uF	±20%	CL05X105MQ3LNN□	Derating

■ Size : 2.00 X 1.25mm (inch : 0805)

Thickness Max.	Rated Voltage	Capacitance	Capacitance Tolerance	Part Number	Remark
0.95mm	2.5Vdc	22uF	±20%	CL21X226MSCLRNN□	Derating
	4.0Vdc	10uF	±10%	CL21X106KRCLRNN□	Derating
	10Vdc	10uF	±10%	CL21X106KPCLRNN□	Derating

■ Size : 3.20 X 1.60mm (inch : 1206)

Thickness Max.	Rated Voltage	Capacitance	Capacitance Tolerance	Part Number	Remark
0.95mm	25Vdc	4.7uF	±10%	CL31X475KACLNN□	

※ □ mark means packaging code. If you want to learn the code or quantity in detail, please see p.148

In order to move to the page directly, please click the here. ↑

Super Small Size Capacitors

Feature



- Small size chip
- 02 and 03 Series (High-Q) MLCC shows very low ESR value
- 02 and 03 Series are suited to only reflow soldering
- 02 and 03 Series are suited to miniature RF module, portable equipment and high frequency circuit

Application

- DC-DC Converter
- Mobile phone, Tablet devices
- PC (Laptop, Desktop)
- HDD/SSD Board

Structure and Dimensions

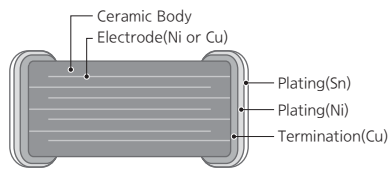
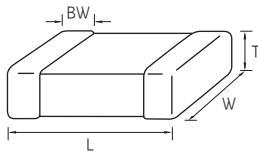

Size Code	EIA Code	Dimension(mm)				
		L	W	T	Thickness Code	BW
02	01005	0.40±0.02	0.20±0.02	0.20±0.02	2	0.10±0.03
03	0201	0.60±0.03	0.30±0.03	0.30±0.03	3	0.15±0.05

Super Small Size Capacitors

Super Small Size Capacitance Table (C0G)

Size inch (mm)	Rated Voltage (Vdc)	Capacitance(pF)						
		0.2	0.5	1.0	10	22	47	100
01005 (0402)	6.3							
	16							
	25					27pF		
0201 (0603)	6.3							
	25							
	50							

Super Small Size Capacitance Table (X5R)

Size inch (mm)	Rated Voltage (Vdc)	Capacitance																			
		pF				nF										uF					
		220	330	470	680	1.0	2.2	3.3	4.7	10	15	22	33	47	68	100	220	470	1.0	2.2	
01005 (0402)	4.0																				
	6.3																				
	10																				
0201 (0603)	4.0																				
	6.3																				
	10																				
	16																				
	25																				

Super Small Size Capacitance Table (X7R)

Size inch (mm)	Rated Voltage (Vdc)	Capacitance																			
		pF					nF														
		100	220	330	470	680	1.0	2.2	3.3	4.7	6.8	10									
01005(0402)	10																				
0201 (0603)	6.3																				
	10																				
	16																				
	25																				
	50																				

Super Small Size Capacitance Table (X6S)

Size inch (mm)	Rated Voltage (Vdc)	Capacitance(nF)											
		2.2	3.3	4.7	6.8	10	22	47	100				
01005(0402)	2.5												
0201 (0603)	4.0												
	6.3												

Product Line Up (COG)

■ Size : 0.40 X 0.20mm (inch : 01005)

Thickness Max.	Rated Voltage	Capacitance	Capacitance Tolerance	Part Number	Thickness Max.	Rated Voltage	Capacitance	Capacitance Tolerance	Part Number
0.22mm	16Vdc	0.2pF	±0.1pF	CL02C0R2B02GNN □	0.22mm	16Vdc	5.1pF	±0.25pF	CL02C5R1C02GNN □
		0.3pF	±0.1pF	CL02C0R3B02GNN □			5.2pF	±0.1pF	CL02C5R2B02GNN □
		0.4pF	±0.1pF	CL02C0R4B02GNN □			5.3pF	±0.1pF	CL02C5R3B02GNN □
		0.5pF	±0.1pF	CL02C0R5B02GNN □			5.4pF	±0.1pF	CL02C5R4B02GNN □
		0.6pF	±0.1pF	CL02C0R6B02GNN □			5.5pF	±0.1pF	CL02C5R5B02GNN □
		0.7pF	±0.1pF	CL02C0R7B02GNN □			5.6pF	±0.1pF	CL02C5R6B02GNN □
		0.8pF	±0.1pF	CL02C0R8B02GNN □			5.6pF	±0.25pF	CL02C5R6C02GNN □
		0.9pF	±0.1pF	CL02C0R9B02GNN □			5.7pF	±0.1pF	CL02C5R7B02GNN □
		1.0pF	±0.1pF	CL02C0I0B02GNN □			5.7pF	±0.25pF	CL02C5R7C02GNN □
		1.1pF	±0.1pF	CL02C1R1B02GNN □			5.8pF	±0.1pF	CL02C5R8B02GNN □
		1.2pF	±0.1pF	CL02C1R2B02GNN □			5.9pF	±0.1pF	CL02C5R9B02GNN □
		1.3pF	±0.1pF	CL02C1R3B02GNN □			6.0pF	±0.1pF	CL02C060B02GNN □
		1.4pF	±0.1pF	CL02C1R4B02GNN □			6.1pF	±0.1pF	CL02C6R1B02GNN □
		1.5pF	±0.1pF	CL02C1R5B02GNN □			6.2pF	±0.1pF	CL02C6R2B02GNN □
		1.6pF	±0.1pF	CL02C1R6B02GNN □			6.3pF	±0.1pF	CL02C6R3B02GNN □
		1.7pF	±0.1pF	CL02C1R7B02GNN □			6.4pF	±0.1pF	CL02C6R4B02GNN □
		1.8pF	±0.1pF	CL02C1R8B02GNN □			6.5pF	±0.1pF	CL02C6R5B02GNN □
		1.9pF	±0.1pF	CL02C1R9B02GNN □			6.6pF	±0.1pF	CL02C6R6B02GNN □
		2.0pF	±0.1pF	CL02C020B02GNN □			6.7pF	±0.1pF	CL02C6R7B02GNN □
		2.1pF	±0.1pF	CL02C2R1B02GNN □			6.8pF	±0.1pF	CL02C6R8B02GNN □
		2.2pF	±0.1pF	CL02C2R2B02GNN □			6.9pF	±0.1pF	CL02C6R9B02GNN □
		2.3pF	±0.1pF	CL02C2R3B02GNN □			7.0pF	±0.1pF	CL02C070B02GNN □
		2.4pF	±0.1pF	CL02C2R4B02GNN □			7.1pF	±0.1pF	CL02C7R1B02GNN □
		2.5pF	±0.1pF	CL02C2R5B02GNN □			7.2pF	±0.1pF	CL02C7R2B02GNN □
		2.6pF	±0.1pF	CL02C2R6B02GNN □			7.3pF	±0.1pF	CL02C7R3B02GNN □
		2.7pF	±0.1pF	CL02C2R7B02GNN □			7.4pF	±0.1pF	CL02C7R4B02GNN □
		2.8pF	±0.1pF	CL02C2R8B02GNN □			7.5pF	±0.1pF	CL02C7R5B02GNN □
		2.9pF	±0.1pF	CL02C2R9B02GNN □			7.6pF	±0.1pF	CL02C7R6B02GNN □
		3.0pF	±0.1pF	CL02C030B02GNN □			7.7pF	±0.1pF	CL02C7R7B02GNN □
		3.1pF	±0.1pF	CL02C3R1B02GNN □			7.8pF	±0.1pF	CL02C7R8B02GNN □
		3.2pF	±0.1pF	CL02C3R2B02GNN □			7.9pF	±0.1pF	CL02C7R9B02GNN □
3.3pF	±0.1pF	CL02C3R3B02GNN □	8.0pF	±0.1pF	CL02C080B02GNN □				
3.3pF	±0.25pF	CL02C3R3C02GNN □	8.0pF	±0.25pF	CL02C080C02GNN □				
3.4pF	±0.1pF	CL02C3R4B02GNN □	8.1pF	±0.1pF	CL02C8R1B02GNN □				
3.5pF	±0.1pF	CL02C3R5B02GNN □	8.2pF	±0.1pF	CL02C8R2B02GNN □				
3.5pF	±0.25pF	CL02C3R5C02GNN □	8.2pF	±0.25pF	CL02C8R2C02GNN □				
3.6pF	±0.1pF	CL02C3R6B02GNN □	8.3pF	±0.1pF	CL02C8R3B02GNN □				
3.7pF	±0.1pF	CL02C3R7B02GNN □	8.4pF	±0.1pF	CL02C8R4B02GNN □				
3.7pF	±0.25pF	CL02C3R7C02GNN □	8.4pF	±0.25pF	CL02C8R4C02GNN □				
3.8pF	±0.1pF	CL02C3R8B02GNN □	8.5pF	±0.1pF	CL02C8R5B02GNN □				
3.9pF	±0.1pF	CL02C3R9B02GNN □	8.6pF	±0.1pF	CL02C8R6B02GNN □				
4.0pF	±0.1pF	CL02C040B02GNN □	8.7pF	±0.1pF	CL02C8R7B02GNN □				
4.1pF	±0.1pF	CL02C4R1B02GNN □	8.8pF	±0.1pF	CL02C8R8B02GNN □				
4.2pF	±0.1pF	CL02C4R2B02GNN □	8.9pF	±0.1pF	CL02C8R9B02GNN □				
4.3pF	±0.1pF	CL02C4R3B02GNN □	9.0pF	±0.1pF	CL02C090B02GNN □				
4.4pF	±0.1pF	CL02C4R4B02GNN □	9.1pF	±0.1pF	CL02C9R1B02GNN □				
4.5pF	±0.1pF	CL02C4R5B02GNN □	9.2pF	±0.1pF	CL02C9R2B02GNN □				
4.6pF	±0.1pF	CL02C4R6B02GNN □	9.3pF	±0.1pF	CL02C9R3B02GNN □				
4.7pF	±0.1pF	CL02C4R7B02GNN □	9.4pF	±0.1pF	CL02C9R4B02GNN □				
4.8pF	±0.1pF	CL02C4R8B02GNN □	9.5pF	±0.1pF	CL02C9R5B02GNN □				
4.9pF	±0.1pF	CL02C4R9B02GNN □	9.5pF	±0.25pF	CL02C9R5C02GNN □				
5.0pF	±0.1pF	CL02C050B02GNN □	9.6pF	±0.1pF	CL02C9R6B02GNN □				
5.0pF	±0.25pF	CL02C050C02GNN □	9.7pF	±0.1pF	CL02C9R7B02GNN □				
5.1pF	±0.1pF	CL02C5R1B02GNN □	9.8pF	±0.1pF	CL02C9R8B02GNN □				

※ □ mark means packaging code. If you want to learn the code or quantity in detail, please see p.148

In order to move to the page directly, please click the here. ↑

Super Small Size Capacitors

Product Line Up (COG)

■ Size : 0.40 X 0.20mm (inch : 01005)

Thickness Max.	Rated Voltage	Capacitance	Capacitance Tolerance	Part Number
0.22mm	16Vdc	9.9pF	±0.1pF	CL02C9R9B02GNN□
		10pF	±5%	CL02C100J02GNN□
		18pF	±2%	CL02C180G02GNN□
		22pF	±2%	CL02C220G02GNN□

■ Size : 0.60 X 0.30mm (inch : 0201)

Thickness Max.	Rated Voltage	Capacitance	Capacitance Tolerance	Part Number
0.33mm	16Vdc	33pF	±5%	CL03C330J03GNN□
		33pF	±5%	CL03C330J03NNN□
	25Vdc	0.2pF	±0.1pF	CL03C0R2BA3GNN□
		0.2pF	±0.25pF	CL03C0R2CA3GNN□
		0.2pF	±0.03pF	CL03C0R2NA3GNN□
		0.3pF	±0.1pF	CL03C0R3BA3GNN□
		0.3pF	±0.25pF	CL03C0R3CA3GNN□
		0.3pF	±0.03pF	CL03C0R3NA3GNN□
		0.4pF	±0.1pF	CL03C0R4BA3GNN□
		0.4pF	±0.25pF	CL03C0R4CA3GNN□
		0.4pF	±0.03pF	CL03C0R4NA3GNN□
		0.5pF	±0.1pF	CL03C0R5BA3GNN□
		0.5pF	±0.25pF	CL03C0R5CA3GNN□
		0.5pF	±0.03pF	CL03C0R5NA3GNN□
		0.6pF	±0.1pF	CL03C0R6BA3GNN□
		0.6pF	±0.25pF	CL03C0R6CA3GNN□
		0.6pF	±0.03pF	CL03C0R6NA3GNN□
		0.7pF	±0.1pF	CL03C0R7BA3GNN□
		0.7pF	±0.03pF	CL03C0R7NA3GNN□
		0.75pF	±0.1pF	CL03CR75BA3GNN□
		0.8pF	±0.1pF	CL03C0R8BA3GNN□
		0.8pF	±0.25pF	CL03C0R8CA3GNN□
		0.8pF	±0.03pF	CL03C0R8NA3GNN□
		0.9pF	±0.1pF	CL03C0R9BA3GNN□
		0.9pF	±0.25pF	CL03C0R9CA3GNN□
		0.9pF	±0.03pF	CL03C0R9NA3GNN□
		1.0pF	±0.1pF	CL03C010BA3GNN□
		1.0pF	±0.25pF	CL03C010CA3GNN□
		1.0pF	±0.03pF	CL03C010NA3GNN□
		1.1pF	±0.1pF	CL03C1R1BA3GNN□
		1.1pF	±0.03pF	CL03C1R1NA3GNN□
		1.2pF	±0.1pF	CL03C1R2BA3GNN□
		1.2pF	±0.25pF	CL03C1R2CA3GNN□
		1.2pF	±0.03pF	CL03C1R2NA3GNN□
	1.3pF	±0.1pF	CL03C1R3BA3GNN□	
	1.3pF	±0.25pF	CL03C1R3CA3GNN□	
	1.3pF	±0.03pF	CL03C1R3NA3GNN□	
	1.4pF	±0.03pF	CL03C1R4NA3GNN□	
	1.5pF	±0.1pF	CL03C1R5BA3GNN□	
	1.5pF	±0.25pF	CL03C1R5CA3GNN□	
	1.5pF	±0.03pF	CL03C1R5NA3GNN□	
	1.6pF	±0.05pF	CL03C1R6AA3GNN□	
	1.6pF	±0.1pF	CL03C1R6BA3GNN□	
	1.6pF	±0.25pF	CL03C1R6CA3GNN□	
	1.7pF	±0.05pF	CL03C1R7AA3GNN□	

Thickness Max.	Rated Voltage	Capacitance	Capacitance Tolerance	Part Number
0.33mm	25Vdc	1.7pF	±0.1pF	CL03C1R7BA3GNN□
		1.7pF	±0.25pF	CL03C1R7CA3GNN□
		1.8pF	±0.05pF	CL03C1R8AA3GNN□
		1.8pF	±0.1pF	CL03C1R8BA3GNN□
		1.8pF	±0.25pF	CL03C1R8CA3GNN□
		1.9pF	±0.05pF	CL03C1R9AA3GNN□
		1.9pF	±0.1pF	CL03C1R9BA3GNN□
		1.9pF	±0.25pF	CL03C1R9CA3GNN□
		2.0pF	±0.05pF	CL03C020AA3GNN□
		2.0pF	±0.1pF	CL03C020BA3GNN□
		2.0pF	±0.25pF	CL03C020CA3GNN□
		2.0pF	±0.1pF	CL03C2R0BA3GNN□
		2.1pF	±0.05pF	CL03C2R1AA3GNN□
		2.1pF	±0.1pF	CL03C2R1BA3GNN□
		2.2pF	±0.05pF	CL03C2R2AA3GNN□
		2.2pF	±0.1pF	CL03C2R2BA3GNN□
		2.2pF	±0.25pF	CL03C2R2CA3GNN□
		2.3pF	±0.05pF	CL03C2R3AA3GNN□
		2.3pF	±0.1pF	CL03C2R3BA3GNN□
		2.4pF	±0.05pF	CL03C2R4AA3GNN□
		2.4pF	±0.1pF	CL03C2R4BA3GNN□
		2.4pF	±0.25pF	CL03C2R4CA3GNN□
		2.5pF	±0.05pF	CL03C2R5AA3GNN□
		2.5pF	±0.1pF	CL03C2R5BA3GNN□
		2.6pF	±0.05pF	CL03C2R6AA3GNN□
		2.6pF	±0.1pF	CL03C2R6BA3GNN□
		2.7pF	±0.05pF	CL03C2R7AA3GNN□
		2.7pF	±0.1pF	CL03C2R7BA3GNN□
		2.7pF	±0.25pF	CL03C2R7CA3GNN□
		2.8pF	±0.05pF	CL03C2R8AA3GNN□
		2.8pF	±0.1pF	CL03C2R8BA3GNN□
		2.9pF	±0.05pF	CL03C2R9AA3GNN□
2.9pF	±0.1pF	CL03C2R9BA3GNN□		
3.0pF	±0.05pF	CL03C030AA3GNN□		
3.0pF	±0.1pF	CL03C030BA3GNN□		
3.0pF	±0.25pF	CL03C030CA3GNN□		
3.1pF	±0.05pF	CL03C3R1AA3GNN□		
3.1pF	±0.1pF	CL03C3R1BA3GNN□		
3.2pF	±0.05pF	CL03C3R2AA3GNN□		
3.2pF	±0.1pF	CL03C3R2BA3GNN□		
3.2pF	±0.25pF	CL03C3R2CA3GNN□		
3.3pF	±0.05pF	CL03C3R3AA3GNN□		
3.3pF	±0.1pF	CL03C3R3BA3GNN□		
3.3pF	±0.25pF	CL03C3R3CA3GNN□		
3.4pF	±0.05pF	CL03C3R4AA3GNN□		
3.4pF	±0.1pF	CL03C3R4BA3GNN□		
3.4pF	±0.25pF	CL03C3R4CA3GNN□		
3.5pF	±0.05pF	CL03C3R5AA3GNN□		
3.6pF	±0.05pF	CL03C3R6AA3GNN□		
3.6pF	±0.1pF	CL03C3R6BA3GNN□		
3.6pF	±0.25pF	CL03C3R6CA3GNN□		
3.7pF	±0.05pF	CL03C3R7AA3GNN□		
3.8pF	±0.05pF	CL03C3R8AA3GNN□		
3.8pF	±0.1pF	CL03C3R8BA3GNN□		

※ □ mark means packaging code. If you want to learn the code or quantity in detail, please see p.148

In order to move to the page directly, please click the here. ↑

Product Line Up (COG)

■ Size : 0.60 X 0.30mm (inch : 0201)

Thickness Max.	Rated Voltage	Capacitance	Capacitance Tolerance	Part Number	Thickness Max.	Rated Voltage	Capacitance	Capacitance Tolerance	Part Number
0.33mm	25Vdc	3.8pF	±0.25pF	CL03C3R8CA3GNN □	0.33mm	25Vdc	6.8pF	±0.25pF	CL03C6R8CA3GNN □
		3.9pF	±0.05pF	CL03C3R9AA3GNN □			6.9pF	±0.05pF	CL03C6R9AA3GNN □
		3.9pF	±0.1pF	CL03C3R9BA3GNN □			7.0pF	±0.05pF	CL03C070AA3GNN □
		3.9pF	±0.25pF	CL03C3R9CA3GNN □			7.0pF	±0.1pF	CL03C070BA3GNN □
		4.0pF	±0.05pF	CL03C040AA3GNN □			7.0pF	±0.25pF	CL03C070CA3GNN □
		4.0pF	±0.1pF	CL03C040BA3GNN □			7.1pF	±0.05pF	CL03C7R1AA3GNN □
		4.0pF	±0.25pF	CL03C040CA3GNN □			7.2pF	±0.05pF	CL03C7R2AA3GNN □
		4.1pF	±0.05pF	CL03C4R1AA3GNN □			7.2pF	±0.1pF	CL03C7R2BA3GNN □
		4.2pF	±0.05pF	CL03C4R2AA3GNN □			7.3pF	±0.05pF	CL03C7R3AA3GNN □
		4.3pF	±0.05pF	CL03C4R3AA3GNN □			7.4pF	±0.05pF	CL03C7R4AA3GNN □
		4.3pF	±0.1pF	CL03C4R3BA3GNN □			7.5pF	±0.05pF	CL03C7R5AA3GNN □
		4.3pF	±0.25pF	CL03C4R3CA3GNN □			7.5pF	±0.1pF	CL03C7R5BA3GNN □
		4.4pF	±0.05pF	CL03C4R4AA3GNN □			7.5pF	±0.25pF	CL03C7R5CA3GNN □
		4.5pF	±0.05pF	CL03C4R5AA3GNN □			7.6pF	±0.05pF	CL03C7R6AA3GNN □
		4.6pF	±0.05pF	CL03C4R6AA3GNN □			7.6pF	±0.05pF	CL03C7R6AA3GNN □
		4.6pF	±0.05pF	CL03C4R6AA3GNN □			7.7pF	±0.05pF	CL03C7R7AA3GNN □
		4.7pF	±0.05pF	CL03C4R7AA3GNN □			7.8pF	±0.05pF	CL03C7R8AA3GNN □
		4.7pF	±0.1pF	CL03C4R7BA3GNN □			7.9pF	±0.05pF	CL03C7R9AA3GNN □
		4.7pF	±0.25pF	CL03C4R7CA3GNN □			8.0pF	±0.05pF	CL03C080AA3GNN □
		4.8pF	±0.05pF	CL03C4R8AA3GNN □			8.0pF	±0.25pF	CL03C080CA3GNN □
		4.9pF	±0.05pF	CL03C4R9AA3GNN □			8.0pF	±0.5pF	CL03C080DA3GNN □
		5.0pF	±0.05pF	CL03C050AA3GNN □			8.1pF	±0.05pF	CL03C8R1AA3GNN □
		5.0pF	±0.1pF	CL03C050BA3GNN □			8.2pF	±0.05pF	CL03C8R2AA3GNN □
		5.0pF	±0.25pF	CL03C050CA3GNN □			8.2pF	±0.1pF	CL03C8R2BA3GNN □
		5.1pF	±0.05pF	CL03C5R1AA3GNN □			8.2pF	±0.25pF	CL03C8R2CA3GNN □
		5.1pF	±0.1pF	CL03C5R1BA3GNN □			8.2pF	±0.5pF	CL03C8R2DA3GNN □
		5.1pF	±0.25pF	CL03C5R1CA3GNN □			8.3pF	±0.05pF	CL03C8R3AA3GNN □
		5.1pF	±0.25pF	CL03C5R1CA3GNN □			8.4pF	±0.05pF	CL03C8R4AA3GNN □
		5.2pF	±0.05pF	CL03C5R2AA3GNN □			8.5pF	±0.05pF	CL03C8R5AA3GNN □
		5.3pF	±0.05pF	CL03C5R3AA3GNN □			8.5pF	±0.25pF	CL03C8R5CA3GNN □
		5.4pF	±0.05pF	CL03C5R4AA3GNN □			8.6pF	±0.05pF	CL03C8R6AA3GNN □
		5.5pF	±0.05pF	CL03C5R5AA3GNN □			8.7pF	±0.05pF	CL03C8R7AA3GNN □
		5.6pF	±0.05pF	CL03C5R6AA3GNN □			8.8pF	±0.05pF	CL03C8R8AA3GNN □
		5.6pF	±0.1pF	CL03C5R6BA3GNN □			8.9pF	±0.05pF	CL03C8R9AA3GNN □
		5.6pF	±0.25pF	CL03C5R6CA3GNN □			9.0pF	±0.05pF	CL03C090AA3GNN □
		5.7pF	±0.05pF	CL03C5R7AA3GNN □			9.0pF	±0.1pF	CL03C090BA3GNN □
		5.8pF	±0.05pF	CL03C5R8AA3GNN □			9.0pF	±0.25pF	CL03C090CA3GNN □
		5.9pF	±0.05pF	CL03C5R9AA3GNN □			9.0pF	±0.5pF	CL03C090DA3GNN □
		6.0pF	±0.05pF	CL03C060AA3GNN □			9.1pF	±0.05pF	CL03C9R1AA3GNN □
		6.0pF	±0.1pF	CL03C060BA3GNN □			9.1pF	±0.1pF	CL03C9R1BA3GNN □
6.0pF	±0.25pF	CL03C060CA3GNN □	9.1pF	±0.25pF	CL03C9R1CA3GNN □				
6.0pF	±0.5pF	CL03C060DA3GNN □	9.1pF	±0.5pF	CL03C9R1DA3GNN □				
6.1pF	±0.05pF	CL03C6R1AA3GNN □	9.2pF	±0.05pF	CL03C9R2AA3GNN □				
6.2pF	±0.05pF	CL03C6R2AA3GNN □	9.3pF	±0.05pF	CL03C9R3AA3GNN □				
6.2pF	±0.1pF	CL03C6R2BA3GNN □	9.4pF	±0.05pF	CL03C9R4AA3GNN □				
6.2pF	±0.25pF	CL03C6R2CA3GNN □	9.5pF	±0.05pF	CL03C9R5AA3GNN □				
6.3pF	±0.05pF	CL03C6R3AA3GNN □	9.6pF	±0.05pF	CL03C9R6AA3GNN □				
6.4pF	±0.05pF	CL03C6R4AA3GNN □	9.7pF	±0.05pF	CL03C9R7AA3GNN □				
6.4pF	±0.25pF	CL03C6R4CA3GNN □	9.8pF	±0.05pF	CL03C9R8AA3GNN □				
6.5pF	±0.05pF	CL03C6R5AA3GNN □	9.9pF	±0.05pF	CL03C9R9AA3GNN □				
6.6pF	±0.05pF	CL03C6R6AA3GNN □	10pF	±0.05pF	CL03C100AA3GNN □				
6.7pF	±0.05pF	CL03C6R7AA3GNN □	10pF	±0.25pF	CL03C100CA3GNN □				
6.8pF	±0.05pF	CL03C6R8AA3GNN □	10pF	±0.5pF	CL03C100DA3GNN □				
6.8pF	±0.1pF	CL03C6R8BA3GNN □	10pF	±2%	CL03C100GA3GNN □				
6.8pF	±0.1pF	CL03C6R8BA3GNN □	10pF	±5%	CL03C100JA3GNN □				

※ □ mark means packaging code. If you want to learn the code or quantity in detail, please see p.148

In order to move to the page directly, please click the here. ↑

Super Small Size Capacitors

Product Line Up (COG)

■ Size : 0.60 X 0.30mm (inch : 0201)

Thickness Max.	Rated Voltage	Capacitance	Capacitance Tolerance	Part Number	Thickness Max.	Rated Voltage	Capacitance	Capacitance Tolerance	Part Number
0.33mm	25Vdc	11pF	±2%	CL03C110GA3GNN□	0.33mm	50Vdc	6.0pF	±0.5pF	CL03C060DB3GNN□
		11pF	±5%	CL03C110JA3GNN□			6.2pF	±0.1pF	CL03C6R2BB3GNN□
		12pF	±2%	CL03C120GA3GNN□			6.5pF	±0.1pF	CL03C6R5BB3GNN□
		12pF	±5%	CL03C120JA3GNN□			7.0pF	±0.1pF	CL03C070BB3GNN□
		12pF	±5%	CL03C120JA3NNN□			7.0pF	±0.5pF	CL03C070DB3GNN□
		13pF	±2%	CL03C130GA3GNN□			7.5pF	±0.1pF	CL03C7R5BB3GNN□
		13pF	±5%	CL03C130JA3GNN□			8.0pF	±0.1pF	CL03C080BB3GNN□
		15pF	±2%	CL03C150GA3GNN□			8.0pF	±0.5pF	CL03C080DB3GNN□
		15pF	±5%	CL03C150JA3GNN□			8.2pF	±0.1pF	CL03C8R2BB3GNN□
		15pF	±5%	CL03C150JA3NNN□			8.2pF	±0.5pF	CL03C8R2DB3GNN□
		16pF	±2%	CL03C160GA3GNN□			10pF	±5%	CL03C100JB3GNN□
		16pF	±5%	CL03C160JA3GNN□			10pF	±5%	CL03C100JB3NNN□
		16pF	+5%	CL03C160JA3GNN□			12pF	±5%	CL03C120JB3NNN□
		18pF	±2%	CL03C180GA3GNN□			15pF	±5%	CL03C150JB3NNN□
		18pF	±5%	CL03C180JA3GNN□			33pF	±5%	CL03C330JB3NNN□
		18pF	±5%	CL03C180JA3NNN□			100pF	±5%	CL03C101JB3NNN□
		20pF	±2%	CL03C200GA3GNN□					
		20pF	±5%	CL03C200JA3GNN□					
		22pF	±2%	CL03C220GA3GNN□					
		22pF	±5%	CL03C220JA3GNN□					
	22pF	±5%	CL03C220JA3NNN□						
	24pF	±5%	CL03C240JA3GNN□						
	27pF	±5%	CL03C270JA3GNN□						
	27pF	±5%	CL03C270JA3NNN□						
	30pF	±5%	CL03C300JA3GNN□						
	33pF	±5%	CL03C330JA3GNN□						
	33pF	±5%	CL03C330JA3NNN□						
	39pF	±5%	CL03C390JA3NNN□						
	47pF	±5%	CL03C470JA3NNN□						
	56pF	±5%	CL03C560JA3NNN□						
	68pF	±5%	CL03C680JA3NNN□						
	82pF	±5%	CL03C820JA3NNN□						
	100pF	±5%	CL03C101JA3NNN□						
	50Vdc	0.5pF	±0.25pF	CL03C0R5CB3GNN□					
		0.75pF	±0.1pF	CL03CR75BB3GNN□					
		0.8pF	±0.25pF	CL03C0R8CB3GNN□					
		1.0pF	±0.1pF	CL03C010BB3GNN□					
		1.2pF	±0.1pF	CL03C1R2BB3GNN□					
		1.2pF	±0.25pF	CL03C1R2CB3GNN□					
		1.5pF	±0.1pF	CL03C1R5BB3GNN□					
1.5pF		±0.25pF	CL03C1R5CB3GNN□						
1.8pF		±0.1pF	CL03C1R8BB3GNN□						
2.0pF		±0.1pF	CL03C020BB3GNN□						
2.0pF		±0.25pF	CL03C020CB3GNN□						
2.2pF		±0.05pF	CL03C2R2AB3GNN□						
2.7pF		±0.1pF	CL03C2R7BB3GNN□						
3.0pF		±0.1pF	CL03C030BB3GNN□						
3.0pF		±0.25pF	CL03C030CB3GNN□						
3.3pF		±0.1pF	CL03C3R3BB3GNN□						
4.0pF	±0.1pF	CL03C040BB3GNN□							
4.7pF	±0.1pF	CL03C4R7BB3GNN□							
5.0pF	±0.1pF	CL03C050BB3GNN□							
5.6pF	±0.1pF	CL03C5R6BB3GNN□							
6.0pF	±0.1pF	CL03C060BB3GNN□							

※ □ mark means packaging code. If you want to learn the code or quantity in detail, please see p.148

In order to move to the page directly, please click the here. ↑

Product Line Up (X5R)

■ Size : 0.40 X 0.20mm (inch : 01005)

Thickness Max.	Rated Voltage	Capacitance	Capacitance Tolerance	Part Number	Remark
0.22mm	4.0Vdc	15nF	±10%	CL02A153KR2NNN □	
		33nF	±10%	CL02A333KR2NNN □	
		47nF	±10%	CL02A473KR2NNN □	
		100nF	±10%	CL02A104KR2NNN □	Derating
		100nF	±20%	CL02A104MR2NNN □	Derating
	6.3Vdc	680pF	±10%	CL02A681KQ2NNN □	
		820pF	±10%	CL02A821KQ2NNN □	
		1.0nF	±10%	CL02A102KQ2NNN □	
		1.2nF	±10%	CL02A122KQ2NNN □	
		1.8nF	±10%	CL02A182KQ2NNN □	
		2.2nF	±10%	CL02A222KQ2NNN □	
		2.7nF	±10%	CL02A272KQ2NNN □	
		3.9nF	±10%	CL02A392KQ2NNN □	
		5.6nF	±10%	CL02A562KQ2NNN □	
		10nF	±10%	CL02A103KQ2NNN □	
		15nF	±10%	CL02A153KQ2NNN □	Derating
		33nF	±10%	CL02A333KQ2NNN □	Derating
		47nF	±10%	CL02A473KQ2NNN □	Derating
		68nF	±10%	CL02A683KQ2NNN □	Derating
		100nF	±10%	CL02A104KQ2NNN □	Derating
	100nF	±20%	CL02A104MQ2NNN □	Derating	
	10Vdc	470pF	±10%	CL02A471KP2NNN □	
		820pF	±10%	CL02A821KP2NNN □	
		1.0nF	±10%	CL02A102KP2NNN □	
		2.2nF	±10%	CL02A222KP2NNN □	
		5.6nF	±10%	CL02A562KP2NNN □	
		10nF	±10%	CL02A103KP2NNN □	

■ Size : 0.60 X 0.30mm (inch : 0201)

Thickness Max.	Rated Voltage	Capacitance	Capacitance Tolerance	Part Number	Remark
0.33mm	4.0Vdc	100nF	±10%	CL03A104KR3NNN □	
		470nF	±10%	CL03A474KR3NNN □	Ref.
		470nF	±20%	CL03A474MR3NNN □	Ref.
	6.3Vdc	330pF	±10%	CL03A331KQ3NNN □	
		10nF	±10%	CL03A103KQ3NNN □	
		12nF	±10%	CL03A123KQ3NNN □	
		15nF	±10%	CL03A153KQ3NNN □	
		22nF	±5%	CL03A223JQ3NNN □	
		22nF	±10%	CL03A223KQ3NNN □	
		33nF	±10%	CL03A333KQ3NNN □	
		47nF	±10%	CL03A473KQ3NNN □	
		82nF	±10%	CL03A823KQ3NNN □	
		100nF	±5%	CL03A104JQ3NNN □	Derating
		100nF	±10%	CL03A104KQ3NNN □	Derating
		100nF	±20%	CL03A104MQ3NNN □	Derating
		220nF	±10%	CL03A224KQ3NNN □	Derating Ref.
		220nF	±20%	CL03A224MQ3NNN □	Derating Ref.
		470nF	±5%	CL03A474JQ3NNN □	Derating Ref.
	470nF	±10%	CL03A474KQ3NNN □	Derating Ref.	
	470nF	±20%	CL03A474MQ3NNN □	Derating Ref.	
	1.5uF	±20%	CL03A155MQ3NNN □	Derating Ref.	

Thickness Max.	Rated Voltage	Capacitance	Capacitance Tolerance	Part Number	Remark	
0.33mm	6.3Vdc	1.0uF	±10%	CL03A105KQ3CNN □	Derating Ref.	
		1.0uF	±10%	CL03A105MQ3CNN □	Derating Ref.	
	10Vdc	330pF	±20%	CL03A331KP3NNN □		
		1.5nF	±10%	CL03A152KP3NNN □		
		2.2nF	±20%	CL03A222KP3NNN □		
		3.3nF	±5%	CL03A332KP3NNN □		
		4.7nF	±10%	CL03A472KP3NNN □		
		8.2nF	±20%	CL03A822KP3NNN □		
		10nF	±10%	CL03A103KP3NNN □		
		15nF	±10%	CL03A153KP3NNN □		
		22nF	±10%	CL03A223KP3NNN □	Derating	
		33nF	±10%	CL03A333KP3NNN □	Derating	
		47nF	±20%	CL03A473KP3NNN □	Derating	
		100nF	±5%	CL03A104KP3NNN □	Derating	
		100nF	±10%	CL03A104MP3NNN □	Derating	
		220nF	±10%	CL03A224KP3NNN □	Derating Ref.	
		220nF	±5%	CL03A224MP3NNN □	Derating Ref.	
	470nF	±10%	CL03A474KP3NNN □	Derating Ref.		
	470nF	±20%	CL03A474MP3NNN □	Derating Ref.		
	16Vdc	220pF	±10%	CL03A221KO3NNN □	Derating	
		330pF	±10%	CL03A331KO3NNN □	Derating	
		470pF	±10%	CL03A471KO3NNN □	Derating	
		10nF	±10%	CL03A103KO3NNN □	Derating	
		22nF	±10%	CL03A223KO3NNN □	Derating	
		47nF	±20%	CL03A473KO3NNN □	Derating	
		100nF	±10%	CL03A104KO3NNN □	Derating	
		100nF	±10%	CL03A104MO3NNN □	Derating	
		25Vdc	1.0nF	±10%	CL03A102KA3NNN □	Derating
			4.7nF	±10%	CL03A472KA3NNN □	Derating
			10nF	±20%	CL03A103KA3NNN □	Derating
			22nF	±10%	CL03A223KA3NNN □	Derating
			100nF	±10%	CL03A104KA3NNN □	Derating
			100nF	±10%	CL03A104MA3NNN □	Derating

※ □ mark means packaging code. If you want to learn the code or quantity in detail, please see p.148

In order to move to the page directly, please click the here. ↑

Super Small Size Capacitors

Product Line Up (X6S)

■ Size : 0.60 X 0.30mm (inch : 0201)

Thickness Max.	Rated Voltage	Capacitance	Capacitance Tolerance	Part Number	Remark
0.33mm	4.0Vdc	2.2nF	±20%	CL03X222MR3NNN□	
		4.7nF	±20%	CL03X472MR3NNN□	
		6.8nF	±20%	CL03X682MR3NNN□	
		15nF	±20%	CL03X153MR3NNN□	
		22nF	±20%	CL03X223MR3NNN□	
		47nF	±20%	CL03X473MR3NNN□	
		100nF	±10%	CL03X104KR3NNN□	Derating
0.39mm	6.3Vdc	100nF	±10%	CL03X104KQ3NNN□	Derating
0.39mm	4.0Vdc	1.0uF	±20%	CL03X105MR3NRR□	Derating Ref

Thickness Max.	Rated Voltage	Capacitance	Capacitance Tolerance	Part Number	Remark	
0.33mm	16Vdc	390pF	±10%	CL03B391K03NNN□		
		470pF	±10%	CL03B471K03NNN□		
		560pF	±10%	CL03B561K03NNN□		
		820pF	±10%	CL03B821K03NNN□		
		1.0nF	±10%	CL03B102K03NNN□		
		3.3nF	±10%	CL03B332K03NNN□		
		10nF	±10%	CL03B103K03NNN□		
		25Vdc	120pF	±10%	CL03B121KA3NNN□	
			150pF	±10%	CL03B151KA3NNN□	
			180pF	±10%	CL03B181KA3NNN□	
	200pF		±10%	CL03B201KA3NNN□		
	220pF		±10%	CL03B221KA3NNN□		
	270pF		±10%	CL03B271KA3NNN□		
	330pF		±10%	CL03B331KA3NNN□		
	390pF		±10%	CL03B391KA3NNN□		
	470pF		±10%	CL03B471KA3NNN□		
	680pF		±5%	CL03B681JA3NNN□		
	50Vdc	680pF	±10%	CL03B681KA3NNN□		
		1.0nF	±5%	CL03B102JA3NNN□		
		1.0nF	±10%	CL03B102KA3NNN□		
220pF		±10%	CL03B221KB3NNN□			
		330pF	±10%	CL03B331KB3NNN□		

Product Line Up (X7R)

■ Size : 0.40 X 0.20mm (inch : 01005)

Thickness Max.	Rated Voltage	Capacitance	Capacitance Tolerance	Part Number	Remark
0.22mm	6.3Vdc	1.0nF	±10%	CL02B102KQ2NNN□	
	10Vdc	100pF	±10%	CL02B101KP2NNN□	
		120pF	±10%	CL02B121KP2NNN□	
		180pF	±10%	CL02B181KP2NNN□	
		220pF	±10%	CL02B221KP2NNN□	
		330pF	±10%	CL02B331KP2NNN□	
		390pF	±10%	CL02B391KP2NNN□	
		1.0nF	±10%	CL02B102KP2NNN□	

■ Size : 0.60 X 0.30mm (inch : 0201)

Thickness Max.	Rated Voltage	Capacitance	Capacitance Tolerance	Part Number	Remark
0.33mm	6.3Vdc	2.2nF	±10%	CL03B222KQ3NNN□	
		3.3nF	±10%	CL03B332KQ3NNN□	
		4.7nF	±10%	CL03B472KQ3NNN□	
		6.8nF	±10%	CL03B682KQ3NNN□	
		10nF	±10%	CL03B103KQ3NNN□	
	10Vdc	470pF	±10%	CL03B471KP3NNN□	
		1.5nF	±10%	CL03B152KP3NNN□	
		2.2nF	±10%	CL03B222KP3NNN□	
		3.3nF	±10%	CL03B332KP3NNN□	
		4.7nF	±10%	CL03B472KP3NNN□	
		6.8nF	±10%	CL03B682KP3NNN□	
		10nF	±10%	CL03B103KP3NNN□	
	16Vdc	10nF	±20%	CL03B103MP3NNN□	
		100pF	±10%	CL03B101K03NNN□	
		120pF	±10%	CL03B121K03NNN□	
		150pF	±10%	CL03B151K03NNN□	
		180pF	±10%	CL03B181K03NNN□	
		220pF	±10%	CL03B221K03NNN□	
		270pF	±10%	CL03B271K03NNN□	
		330pF	±10%	CL03B331K03NNN□	

※ □ mark means packaging code. If you want to learn the code or quantity in detail, please see p.148

In order to move to the page directly, please click the here. ↑

High Q Capacitors

Feature



- High Q and low ESR in high frequency range
- Tight tolerance available
- High efficiency and low power consumption in RF circuit

Application

- Mobile Phone
- Set Top Box
- Wireless Equipment
- GPS, Bluetooth

Structure and Dimensions

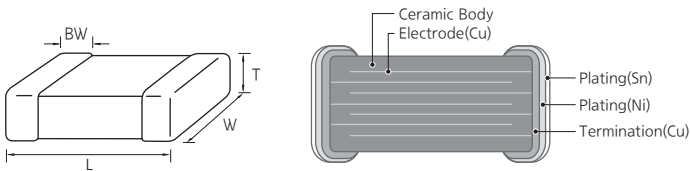

Size Code	EIA Code	Rated Voltage (Vdc)	Dimension(mm)			
			L	W	T	BW
02	01005	16	0.40±0.02	0.20±0.02	0.20±0.02	0.10±0.03
03	0201	25 / 50	0.60±0.03	0.30±0.03	0.30±0.03	0.15±0.05

High Q Capacitance Table (C0G)

Size inch (mm)	Rated Voltage (Vdc)	Capacitance(pF)																			
		0.2	0.4	0.6	0.8	1.0	1.2	1.4	1.6	1.8	2.0	2.2	2.4	2.6	2.8	3.0	3.2	3.4	3.6	3.8	4.0
01005(0402)	16																				
0201 (0603)	25																				
	50																				

Size inch (mm)	Rated Voltage (Vdc)	Capacitance(pF)																			
		4.2	4.4	4.6	4.8	5.0	5.2	5.4	5.6	5.8	6.0	6.2	6.4	6.6	6.8	7.0	7.2	7.4	7.6	7.8	8.0
01005(0402)	16																				
0201 (0603)	25																				
	50																				

Size inch (mm)	Rated Voltage (Vdc)	Capacitance(pF)																			
		8.2	8.4	8.6	8.8	9.0	9.2	9.4	9.7	10	11	12	14	16	18	20	22	24	27	30	33
01005(0402)	16																				
0201 (0603)	25																				
	50																				

High Q Capacitors

Product Line Up (COG)

■ Size : 0.40 X 0.20mm (inch : 01005)

Thickness Max.	Rated Voltage	Capacitance	Capacitance Tolerance	Part Number	Thickness Max.	Rated Voltage	Capacitance	Capacitance Tolerance	Part Number
0.22mm	16Vdc	0.2pF	±0.1pF	CL02C0R2B02GNN□	0.22mm	16Vdc	5.1pF	±0.25pF	CL02C5R1C02GNN□
		0.3pF	±0.1pF	CL02C0R3B02GNN□			5.2pF	±0.1pF	CL02C5R2B02GNN□
		0.4pF	±0.1pF	CL02C0R4B02GNN□			5.3pF	±0.1pF	CL02C5R3B02GNN□
		0.5pF	±0.1pF	CL02C0R5B02GNN□			5.4pF	±0.1pF	CL02C5R4B02GNN□
		0.6pF	±0.1pF	CL02C0R6B02GNN□			5.5pF	±0.1pF	CL02C5R5B02GNN□
		0.7pF	±0.1pF	CL02C0R7B02GNN□			5.6pF	±0.1pF	CL02C5R6B02GNN□
		0.8pF	±0.1pF	CL02C0R8B02GNN□			5.6pF	±0.25pF	CL02C5R6C02GNN□
		0.9pF	±0.1pF	CL02C0R9B02GNN□			5.7pF	±0.1pF	CL02C5R7B02GNN□
		1.0pF	±0.1pF	CL02C0I0B02GNN□			5.7pF	±0.25pF	CL02C5R7C02GNN□
		1.1pF	±0.1pF	CL02C1R1B02GNN□			5.8pF	±0.1pF	CL02C5R8B02GNN□
		1.2pF	±0.1pF	CL02C1R2B02GNN□			5.9pF	±0.1pF	CL02C5R9B02GNN□
		1.3pF	±0.1pF	CL02C1R3B02GNN□			6.0pF	±0.1pF	CL02C060B02GNN□
		1.4pF	±0.1pF	CL02C1R4B02GNN□			6.1pF	±0.1pF	CL02C6R1B02GNN□
		1.5pF	±0.1pF	CL02C1R5B02GNN□			6.2pF	±0.1pF	CL02C6R2B02GNN□
		1.6pF	±0.1pF	CL02C1R6B02GNN□			6.3pF	±0.1pF	CL02C6R3B02GNN□
		1.7pF	±0.1pF	CL02C1R7B02GNN□			6.4pF	±0.1pF	CL02C6R4B02GNN□
		1.8pF	±0.1pF	CL02C1R8B02GNN□			6.5pF	±0.1pF	CL02C6R5B02GNN□
		1.9pF	±0.1pF	CL02C1R9B02GNN□			6.6pF	±0.1pF	CL02C6R6B02GNN□
		2.0pF	±0.1pF	CL02C020B02GNN□			6.7pF	±0.1pF	CL02C6R7B02GNN□
		2.1pF	±0.1pF	CL02C2R1B02GNN□			6.8pF	±0.1pF	CL02C6R8B02GNN□
		2.2pF	±0.1pF	CL02C2R2B02GNN□			6.9pF	±0.1pF	CL02C6R9B02GNN□
		2.3pF	±0.1pF	CL02C2R3B02GNN□			7.0pF	±0.1pF	CL02C070B02GNN□
		2.4pF	±0.1pF	CL02C2R4B02GNN□			7.1pF	±0.1pF	CL02C7R1B02GNN□
		2.5pF	±0.1pF	CL02C2R5B02GNN□			7.2pF	±0.1pF	CL02C7R2B02GNN□
		2.6pF	±0.1pF	CL02C2R6B02GNN□			7.3pF	±0.1pF	CL02C7R3B02GNN□
		2.7pF	±0.1pF	CL02C2R7B02GNN□			7.4pF	±0.1pF	CL02C7R4B02GNN□
		2.8pF	±0.1pF	CL02C2R8B02GNN□			7.5pF	±0.1pF	CL02C7R5B02GNN□
		2.9pF	±0.1pF	CL02C2R9B02GNN□			7.6pF	±0.1pF	CL02C7R6B02GNN□
		3.0pF	±0.1pF	CL02C030B02GNN□			7.7pF	±0.1pF	CL02C7R7B02GNN□
		3.1pF	±0.1pF	CL02C3R1B02GNN□			7.8pF	±0.1pF	CL02C7R8B02GNN□
		3.2pF	±0.1pF	CL02C3R2B02GNN□			7.9pF	±0.1pF	CL02C7R9B02GNN□
3.3pF	±0.1pF	CL02C3R3B02GNN□	8.0pF	±0.1pF	CL02C080B02GNN□				
3.3pF	±0.25pF	CL02C3R3C02GNN□	8.0pF	±0.25pF	CL02C080C02GNN□				
3.4pF	±0.1pF	CL02C3R4B02GNN□	8.1pF	±0.1pF	CL02C8R1B02GNN□				
3.5pF	±0.1pF	CL02C3R5B02GNN□	8.2pF	±0.1pF	CL02C8R2B02GNN□				
3.5pF	±0.25pF	CL02C3R5C02GNN□	8.2pF	±0.25pF	CL02C8R2C02GNN□				
3.6pF	±0.1pF	CL02C3R6B02GNN□	8.3pF	±0.1pF	CL02C8R3B02GNN□				
3.7pF	±0.1pF	CL02C3R7B02GNN□	8.4pF	±0.1pF	CL02C8R4B02GNN□				
3.7pF	±0.25pF	CL02C3R7C02GNN□	8.4pF	±0.25pF	CL02C8R4C02GNN□				
3.8pF	±0.1pF	CL02C3R8B02GNN□	8.5pF	±0.1pF	CL02C8R5B02GNN□				
3.9pF	±0.1pF	CL02C3R9B02GNN□	8.6pF	±0.1pF	CL02C8R6B02GNN□				
4.0pF	±0.1pF	CL02C040B02GNN□	8.7pF	±0.1pF	CL02C8R7B02GNN□				
4.1pF	±0.1pF	CL02C4R1B02GNN□	8.8pF	±0.1pF	CL02C8R8B02GNN□				
4.2pF	±0.1pF	CL02C4R2B02GNN□	8.9pF	±0.1pF	CL02C8R9B02GNN□				
4.3pF	±0.1pF	CL02C4R3B02GNN□	9.0pF	±0.1pF	CL02C090B02GNN□				
4.4pF	±0.1pF	CL02C4R4B02GNN□	9.1pF	±0.1pF	CL02C9R1B02GNN□				
4.5pF	±0.1pF	CL02C4R5B02GNN□	9.2pF	±0.1pF	CL02C9R2B02GNN□				
4.6pF	±0.1pF	CL02C4R6B02GNN□	9.3pF	±0.1pF	CL02C9R3B02GNN□				
4.7pF	±0.1pF	CL02C4R7B02GNN□	9.4pF	±0.1pF	CL02C9R4B02GNN□				
4.8pF	±0.1pF	CL02C4R8B02GNN□	9.5pF	±0.1pF	CL02C9R5B02GNN□				
4.9pF	±0.1pF	CL02C4R9B02GNN□	9.5pF	±0.25pF	CL02C9R5C02GNN□				
5.0pF	±0.1pF	CL02C050B02GNN□	9.6pF	±0.1pF	CL02C9R6B02GNN□				
5.0pF	±0.25pF	CL02C050C02GNN□	9.7pF	±0.1pF	CL02C9R7B02GNN□				
5.1pF	±0.1pF	CL02C5R1B02GNN□	9.8pF	±0.1pF	CL02C9R8B02GNN□				

* □ mark means packaging code. If you want to learn the code or quantity in detail, please see p.148

In order to move to the page directly, please click the here. †

Product Line Up (COG)

■ Size : 0.40 X 0.20mm (inch : 01005)

Thickness Max.	Rated Voltage	Capacitance	Capacitance Tolerance	Part Number
0.22mm	16Vdc	9.9pF	±0.1pF	CL02C9R9B02GNN □
		10pF	±5%	CL02C100J02GNN □
		18pF	±2%	CL02C180G02GNN □
		22pF	±2%	CL02C220G02GNN □

■ Size : 0.60 X 0.30mm (inch : 0201)

Thickness Max.	Rated Voltage	Capacitance	Capacitance Tolerance	Part Number
0.33mm	25Vdc	0.2pF	±0.1pF	CL03C0R2BA3GNN □
		0.2pF	±0.25pF	CL03C0R2CA3GNN □
		0.2pF	±0.03pF	CL03C0R2NA3GNN □
		0.3pF	±0.1pF	CL03C0R3BA3GNN □
		0.3pF	±0.25pF	CL03C0R3CA3GNN □
		0.3pF	±0.03pF	CL03C0R3NA3GNN □
		0.4pF	±0.1pF	CL03C0R4BA3GNN □
		0.4pF	±0.25pF	CL03C0R4CA3GNN □
		0.4pF	±0.03pF	CL03C0R4NA3GNN □
		0.5pF	±0.1pF	CL03C0R5BA3GNN □
		0.5pF	±0.25pF	CL03C0R5CA3GNN □
		0.5pF	±0.03pF	CL03C0R5NA3GNN □
		0.6pF	±0.1pF	CL03C0R6BA3GNN □
		0.6pF	±0.25pF	CL03C0R6CA3GNN □
		0.6pF	±0.03pF	CL03C0R6NA3GNN □
		0.7pF	±0.1pF	CL03C0R7BA3GNN □
		0.7pF	±0.03pF	CL03C0R7NA3GNN □
		0.75pF	±0.1pF	CL03CR75BA3GNN □
		0.8pF	±0.1pF	CL03C0R8BA3GNN □
		0.8pF	±0.25pF	CL03C0R8CA3GNN □
		0.8pF	±0.03pF	CL03C0R8NA3GNN □
		0.9pF	±0.1pF	CL03C0R9BA3GNN □
		0.9pF	±0.25pF	CL03C0R9CA3GNN □
		0.9pF	±0.03pF	CL03C0R9NA3GNN □
		1.0pF	±0.1pF	CL03C010BA3GNN □
		1.0pF	±0.25pF	CL03C010CA3GNN □
		1.0pF	±0.03pF	CL03C010NA3GNN □
		1.1pF	±0.1pF	CL03C1R1BA3GNN □
		1.1pF	±0.03pF	CL03C1R1NA3GNN □
		1.2pF	±0.1pF	CL03C1R2BA3GNN □
		1.2pF	±0.25pF	CL03C1R2CA3GNN □
		1.2pF	±0.03pF	CL03C1R2NA3GNN □
		1.3pF	±0.1pF	CL03C1R3BA3GNN □
		1.3pF	±0.25pF	CL03C1R3CA3GNN □
		1.3pF	±0.03pF	CL03C1R3NA3GNN □
		1.4pF	±0.03pF	CL03C1R4NA3GNN □
		1.5pF	±0.1pF	CL03C1R5BA3GNN □
		1.5pF	±0.25pF	CL03C1R5CA3GNN □
		1.5pF	±0.03pF	CL03C1R5NA3GNN □
		1.6pF	±0.05pF	CL03C1R6AA3GNN □
1.6pF	±0.1pF	CL03C1R6BA3GNN □		
1.6pF	±0.25pF	CL03C1R6CA3GNN □		
1.7pF	±0.05pF	CL03C1R7AA3GNN □		
1.7pF	±0.1pF	CL03C1R7BA3GNN □		
1.7pF	±0.25pF	CL03C1R7CA3GNN □		

Thickness Max.	Rated Voltage	Capacitance	Capacitance Tolerance	Part Number
0.33mm	25Vdc	1.8pF	±0.05pF	CL03C1R8AA3GNN □
		1.8pF	±0.1pF	CL03C1R8BA3GNN □
		1.8pF	±0.25pF	CL03C1R8CA3GNN □
		1.9pF	±0.05pF	CL03C1R9AA3GNN □
		1.9pF	±0.1pF	CL03C1R9BA3GNN □
		1.9pF	±0.25pF	CL03C1R9CA3GNN □
		2.0pF	±0.05pF	CL03C020AA3GNN □
		2.0pF	±0.1pF	CL03C020BA3GNN □
		2.0pF	±0.25pF	CL03C020CA3GNN □
		2.0pF	±0.1pF	CL03C2R0BA3GNN □
		2.1pF	±0.05pF	CL03C2R1AA3GNN □
		2.1pF	±0.1pF	CL03C2R1BA3GNN □
		2.2pF	±0.05pF	CL03C2R2AA3GNN □
		2.2pF	±0.1pF	CL03C2R2BA3GNN □
		2.2pF	±0.25pF	CL03C2R2CA3GNN □
		2.3pF	±0.05pF	CL03C2R3AA3GNN □
		2.3pF	±0.1pF	CL03C2R3BA3GNN □
		2.4pF	±0.05pF	CL03C2R4AA3GNN □
		2.4pF	±0.1pF	CL03C2R4BA3GNN □
		2.4pF	±0.25pF	CL03C2R4CA3GNN □
		2.5pF	±0.05pF	CL03C2R5AA3GNN □
		2.5pF	±0.1pF	CL03C2R5BA3GNN □
		2.6pF	±0.05pF	CL03C2R6AA3GNN □
		2.6pF	±0.1pF	CL03C2R6BA3GNN □
		2.7pF	±0.05pF	CL03C2R7AA3GNN □
		2.7pF	±0.1pF	CL03C2R7BA3GNN □
		2.7pF	±0.25pF	CL03C2R7CA3GNN □
		2.8pF	±0.05pF	CL03C2R8AA3GNN □
		2.8pF	±0.1pF	CL03C2R8BA3GNN □
		2.9pF	±0.05pF	CL03C2R9AA3GNN □
		2.9pF	±0.1pF	CL03C2R9BA3GNN □
		3.0pF	±0.05pF	CL03C030AA3GNN □
		3.0pF	±0.1pF	CL03C030BA3GNN □
		3.0pF	±0.25pF	CL03C030CA3GNN □
		3.1pF	±0.05pF	CL03C3R1AA3GNN □
		3.1pF	±0.1pF	CL03C3R1BA3GNN □
		3.2pF	±0.05pF	CL03C3R2AA3GNN □
		3.2pF	±0.1pF	CL03C3R2BA3GNN □
		3.2pF	±0.25pF	CL03C3R2CA3GNN □
		3.3pF	±0.05pF	CL03C3R3AA3GNN □
3.3pF	±0.1pF	CL03C3R3BA3GNN □		
3.3pF	±0.25pF	CL03C3R3CA3GNN □		
3.4pF	±0.05pF	CL03C3R4AA3GNN □		
3.4pF	±0.1pF	CL03C3R4BA3GNN □		
3.4pF	±0.25pF	CL03C3R4CA3GNN □		
3.5pF	±0.05pF	CL03C3R5AA3GNN □		
3.6pF	±0.05pF	CL03C3R6AA3GNN □		
3.6pF	±0.1pF	CL03C3R6BA3GNN □		
3.6pF	±0.25pF	CL03C3R6CA3GNN □		
3.7pF	±0.05pF	CL03C3R7AA3GNN □		
3.8pF	±0.05pF	CL03C3R8AA3GNN □		
3.8pF	±0.1pF	CL03C3R8BA3GNN □		
3.8pF	±0.25pF	CL03C3R8CA3GNN □		
3.9pF	±0.05pF	CL03C3R9AA3GNN □		

※ □ mark means packaging code. If you want to learn the code or quantity in detail, please see p.148

In order to move to the page directly, please click the here. ↑

High Q Capacitors

Product Line Up (COG)

■ Size : 0.60 X 0.30mm (inch : 0201)

Thickness Max.	Rated Voltage	Capacitance	Capacitance Tolerance	Part Number	Thickness Max.	Rated Voltage	Capacitance	Capacitance Tolerance	Part Number
0.33mm	25Vdc	3.9pF	±0.1pF	CL03C3R9BA3GNN□	0.33mm	25Vdc	7.0pF	±0.25pF	CL03C070CA3GNN□
		3.9pF	±0.25pF	CL03C3R9CA3GNN□			7.1pF	±0.05pF	CL03C7R1AA3GNN□
		4.0pF	±0.05pF	CL03C040AA3GNN□			7.2pF	±0.05pF	CL03C7R2AA3GNN□
		4.0pF	±0.1pF	CL03C040BA3GNN□			7.2pF	±0.1pF	CL03C7R2BA3GNN□
		4.0pF	±0.25pF	CL03C040CA3GNN□			7.3pF	±0.05pF	CL03C7R3AA3GNN□
		4.1pF	±0.05pF	CL03C4R1AA3GNN□			7.4pF	±0.05pF	CL03C7R4AA3GNN□
		4.2pF	±0.05pF	CL03C4R2AA3GNN□			7.5pF	±0.05pF	CL03C7R5AA3GNN□
		4.3pF	±0.05pF	CL03C4R3AA3GNN□			7.5pF	±0.1pF	CL03C7R5BA3GNN□
		4.3pF	±0.1pF	CL03C4R3BA3GNN□			7.5pF	±0.25pF	CL03C7R5CA3GNN□
		4.3pF	±0.25pF	CL03C4R3CA3GNN□			7.6pF	±0.05pF	CL03C7R6AA3GNN□
		4.4pF	±0.05pF	CL03C4R4AA3GNN□			7.7pF	±0.05pF	CL03C7R7AA3GNN□
		4.5pF	±0.05pF	CL03C4R5AA3GNN□			7.8pF	±0.05pF	CL03C7R8AA3GNN□
		4.6pF	±0.05pF	CL03C4R6AA3GNN□			7.9pF	±0.05pF	CL03C7R9AA3GNN□
		4.7pF	±0.05pF	CL03C4R7AA3GNN□			8.0pF	±0.05pF	CL03C080AA3GNN□
		4.7pF	±0.1pF	CL03C4R7BA3GNN□			8.0pF	±0.25pF	CL03C080CA3GNN□
		4.7pF	±0.25pF	CL03C4R7CA3GNN□			8.0pF	±0.5pF	CL03C080DA3GNN□
		4.8pF	±0.05pF	CL03C4R8AA3GNN□			8.1pF	±0.05pF	CL03C8R1AA3GNN□
		4.9pF	±0.05pF	CL03C4R9AA3GNN□			8.2pF	±0.05pF	CL03C8R2AA3GNN□
		5.0pF	±0.05pF	CL03C050AA3GNN□			8.2pF	±0.1pF	CL03C8R2BA3GNN□
		5.0pF	±0.1pF	CL03C050BA3GNN□			8.2pF	±0.25pF	CL03C8R2CA3GNN□
		5.0pF	±0.25pF	CL03C050CA3GNN□			8.2pF	±0.5pF	CL03C8R2DA3GNN□
		5.1pF	±0.05pF	CL03C5R1AA3GNN□			8.3pF	±0.05pF	CL03C8R3AA3GNN□
		5.1pF	±0.1pF	CL03C5R1BA3GNN□			8.4pF	±0.05pF	CL03C8R4AA3GNN□
		5.1pF	±0.25pF	CL03C5R1CA3GNN□			8.5pF	±0.05pF	CL03C8R5AA3GNN□
		5.2pF	±0.05pF	CL03C5R2AA3GNN□			8.5pF	±0.25pF	CL03C8R5CA3GNN□
		5.3pF	±0.05pF	CL03C5R3AA3GNN□			8.6pF	±0.05pF	CL03C8R6AA3GNN□
		5.4pF	±0.05pF	CL03C5R4AA3GNN□			8.7pF	±0.05pF	CL03C8R7AA3GNN□
		5.5pF	±0.05pF	CL03C5R5AA3GNN□			8.8pF	±0.05pF	CL03C8R8AA3GNN□
		5.6pF	±0.05pF	CL03C5R6AA3GNN□			8.9pF	±0.05pF	CL03C8R9AA3GNN□
		5.6pF	±0.1pF	CL03C5R6BA3GNN□			9.0pF	±0.05pF	CL03C090AA3GNN□
		5.6pF	±0.25pF	CL03C5R6CA3GNN□			9.0pF	±0.1pF	CL03C090BA3GNN□
		5.7pF	±0.05pF	CL03C5R7AA3GNN□			9.0pF	±0.25pF	CL03C090CA3GNN□
		5.8pF	±0.05pF	CL03C5R8AA3GNN□			9.0pF	±0.5pF	CL03C090DA3GNN□
		5.9pF	±0.05pF	CL03C5R9AA3GNN□			9.1pF	±0.05pF	CL03C9R1AA3GNN□
		6.0pF	±0.05pF	CL03C060AA3GNN□			9.1pF	±0.1pF	CL03C9R1BA3GNN□
		6.0pF	±0.1pF	CL03C060BA3GNN□			9.1pF	±0.25pF	CL03C9R1CA3GNN□
		6.0pF	±0.25pF	CL03C060CA3GNN□			9.1pF	±0.5pF	CL03C9R1DA3GNN□
		6.0pF	±0.5pF	CL03C060DA3GNN□			9.2pF	±0.05pF	CL03C9R2AA3GNN□
		6.1pF	±0.05pF	CL03C6R1AA3GNN□			9.3pF	±0.05pF	CL03C9R3AA3GNN□
		6.2pF	±0.05pF	CL03C6R2AA3GNN□			9.4pF	±0.05pF	CL03C9R4AA3GNN□
		6.2pF	±0.1pF	CL03C6R2BA3GNN□			9.5pF	±0.05pF	CL03C9R5AA3GNN□
		6.2pF	±0.25pF	CL03C6R2CA3GNN□			9.6pF	±0.05pF	CL03C9R6AA3GNN□
6.3pF	±0.05pF	CL03C6R3AA3GNN□	9.7pF	±0.05pF	CL03C9R7AA3GNN□				
6.4pF	±0.05pF	CL03C6R4AA3GNN□	9.8pF	±0.05pF	CL03C9R8AA3GNN□				
6.4pF	±0.25pF	CL03C6R4CA3GNN□	9.9pF	±0.05pF	CL03C9R9AA3GNN□				
6.5pF	±0.05pF	CL03C6R5AA3GNN□	10pF	±0.05pF	CL03C100AA3GNN□				
6.6pF	±0.05pF	CL03C6R6AA3GNN□	10pF	±0.25pF	CL03C100CA3GNN□				
6.7pF	±0.05pF	CL03C6R7AA3GNN□	10pF	±0.5pF	CL03C100DA3GNN□				
6.8pF	±0.05pF	CL03C6R8AA3GNN□	10pF	±2%	CL03C100GA3GNN□				
6.8pF	±0.1pF	CL03C6R8BA3GNN□	10pF	±5%	CL03C100JA3GNN□				
6.8pF	±0.25pF	CL03C6R8CA3GNN□	11pF	±2%	CL03C110GA3GNN□				
6.9pF	±0.05pF	CL03C6R9AA3GNN□	11pF	±5%	CL03C110JA3GNN□				
7.0pF	±0.05pF	CL03C070AA3GNN□	12pF	±2%	CL03C120GA3GNN□				
7.0pF	±0.1pF	CL03C070BA3GNN□	12pF	±5%	CL03C120JA3GNN□				

※ □ mark means packaging code. If you want to learn the code or quantity in detail, please see p.148

In order to move to the page directly, please click the here. ↑

Product Line Up (COG)

■ Size : 0.60 X 0.30mm (inch : 0201)

Thickness Max.	Rated Voltage	Capacitance	Capacitance Tolerance	Part Number
0.33mm	25Vdc	13pF	±2%	CL03C130GA3GNN □
		13pF	±5%	CL03C130JA3GNN □
		15pF	±2%	CL03C150GA3GNN □
		15pF	±5%	CL03C150JA3GNN □
		16pF	±2%	CL03C160GA3GNN □
		16pF	±5%	CL03C160JA3GNN □
		16pF	±5%	CL03C160UA3GNN □
		18pF	±2%	CL03C180GA3GNN □
		18pF	±5%	CL03C180JA3GNN □
		20pF	±2%	CL03C200GA3GNN □
		20pF	±5%	CL03C200JA3GNN □
		22pF	±2%	CL03C220GA3GNN □
		22pF	±5%	CL03C220JA3GNN □
		24pF	±5%	CL03C240JA3GNN □
		27pF	±5%	CL03C270JA3GNN □
	30pF	±5%	CL03C300JA3GNN □	
	33pF	±5%	CL03C330JA3GNN □	
	50Vdc	0.5pF	±0.25pF	CL03C0R5CB3GNN □
		0.75pF	±0.1pF	CL03CR75BB3GNN □
		0.8pF	±0.25pF	CL03C0R8CB3GNN □
		1.0pF	±0.1pF	CL03C010BB3GNN □
		1.2pF	±0.1pF	CL03C1R2BB3GNN □
		1.2pF	±0.25pF	CL03C1R2CB3GNN □
		1.5pF	±0.1pF	CL03C1R5BB3GNN □
		1.5pF	±0.25pF	CL03C1R5CB3GNN □
		1.8pF	±0.1pF	CL03C1R8BB3GNN □
		2.0pF	±0.1pF	CL03C020BB3GNN □
		2.0pF	±0.25pF	CL03C020CB3GNN □
		2.2pF	±0.05pF	CL03C2R2AB3GNN □
		2.7pF	±0.1pF	CL03C2R7BB3GNN □
		3.0pF	±0.1pF	CL03C030BB3GNN □
		3.0pF	±0.25pF	CL03C030CB3GNN □
		3.3pF	±0.1pF	CL03C3R3BB3GNN □
		4.0pF	±0.1pF	CL03C040BB3GNN □
		4.7pF	±0.1pF	CL03C4R7BB3GNN □
5.0pF		±0.1pF	CL03C050BB3GNN □	
5.6pF		±0.1pF	CL03C5R6BB3GNN □	
6.0pF	±0.1pF	CL03C060BB3GNN □		
6.0pF	±0.5pF	CL03C060DB3GNN □		
6.2pF	±0.1pF	CL03C6R2BB3GNN □		
6.5pF	±0.1pF	CL03C6R5BB3GNN □		
7.0pF	±0.1pF	CL03C070BB3GNN □		
7.0pF	±0.5pF	CL03C070DB3GNN □		
7.5pF	±0.1pF	CL03C7R5BB3GNN □		
8.0pF	±0.1pF	CL03C080BB3GNN □		
8.0pF	±0.5pF	CL03C080DB3GNN □		
8.2pF	±0.1pF	CL03C8R2BB3GNN □		
8.2pF	±0.5pF	CL03C8R2DB3GNN □		
10pF	±5%	CL03C100JB3GNN □		

※ □ mark means packaging code. If you want to learn the code or quantity in detail, please see p.148
In order to move to the page directly, please click the here. †

Medium – High Voltage Capacitors

Feature



- Highly reliable performance
- Operating at high voltage level
- Wide voltage level : from 100V to 3kV
- High withstanding voltage
- Tape & reel surface mount assembly

Application

- Switching Power Circuit (SMPS)
- Lighting Ballast, LCD Back Lighting Inverter
- DC - DC converter input filter, Snubber Circuit
- Network (IEEE802.3)

Structure and Dimensions

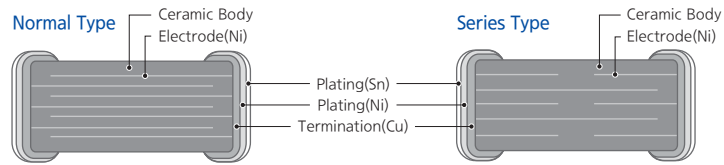
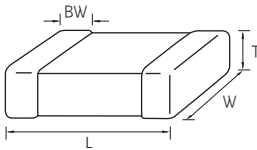

Size Code	EIA Code	Dimension(mm)				
		L	W	T	Thickness Code	BW
05	0402	1.00±0.05	0.50±0.05	0.50±0.05	5	0.25±0.10
10	0603	1.60±0.10	0.80±0.10	0.80±0.10	8	0.30±0.20
21	0805	2.00±0.10	1.25±0.10	0.65±0.10	A	0.50+0.20/-0.30
		2.00±0.10	1.25±0.10	0.85±0.10	C	
		2.00±0.10	1.25±0.10	1.15±0.10	M	
		2.00±0.10	1.25±0.10	1.25±0.10	F	
31	1206	3.20±0.15	1.60±0.15	0.85±0.15	C	0.50±0.30
		3.20±0.15	1.60±0.15	1.25±0.15	F	
		3.20±0.20	1.60±0.20	1.60±0.20	H	
32	1210	3.20±0.30	2.50±0.20	1.25±0.20	F	0.60±0.30
		3.20±0.30	2.50±0.20	1.60±0.20	H	
		3.20±0.30	2.50±0.20	2.00±0.20	I	
		3.20±0.30	2.50±0.20	2.50±0.20	J	
42	1808	4.50±0.40	2.00±0.20	1.25±0.20	F	0.80±0.30
		4.50±0.40	2.00±0.20	1.60±0.20	H	
		4.50±0.40	2.00±0.20	2.00±0.20	I	
43	1812	4.50±0.40	3.20±0.30	1.25±0.20	F	0.80±0.30
		4.50±0.40	3.20±0.30	1.60±0.20	H	
		4.50±0.40	3.20±0.30	2.00±0.20	I	
		4.50±0.40	3.20±0.30	2.50±0.20	J	
55	2220	5.70±0.40	5.00±0.40	2.50±0.20	J	1.00±0.30

Medium - High Voltage Capacitance Table (COG)

Size inch (mm)	Rated Voltage (Vdc)	Capacitance																																
		pF													nF																			
		47	100	120	150	180	220	270	330	390	470	560	680	820	1.0	1.2	1.5	1.8	2.2	2.7	3.3	3.9	4.7	5.6	6.8	8.2	10	12	15	18	22	27	33	47
0402(1005)	100	[Bar chart showing capacitance values for 100V in 0402 size]																																
	200	[Bar chart showing capacitance values for 200V in 0402 size]																																
0603 (1608)	100	[Bar chart showing capacitance values for 100V in 0603 size]																																
	250	[Bar chart showing capacitance values for 250V in 0603 size]																																
0805 (2012)	100	[Bar chart showing capacitance values for 100V in 0805 size]																																
	200	[Bar chart showing capacitance values for 200V in 0805 size]																																
	250	[Bar chart showing capacitance values for 250V in 0805 size]																																
	500	[Bar chart showing capacitance values for 500V in 0805 size]																																
	630	[Bar chart showing capacitance values for 630V in 0805 size]																																
1206 (3216)	100	[Bar chart showing capacitance values for 100V in 1206 size]																																
	200	[Bar chart showing capacitance values for 200V in 1206 size]																																
	250	[Bar chart showing capacitance values for 250V in 1206 size]																																
	500	[Bar chart showing capacitance values for 500V in 1206 size]																																
	630	[Bar chart showing capacitance values for 630V in 1206 size]																																
	1k	[Bar chart showing capacitance values for 1kV in 1206 size]																																
	2k	[Bar chart showing capacitance values for 2kV in 1206 size]																																
1210 (3225)	100	[Bar chart showing capacitance values for 100V in 1210 size]																																
	200	[Bar chart showing capacitance values for 200V in 1210 size]																																
	250	[Bar chart showing capacitance values for 250V in 1210 size]																																
	500	[Bar chart showing capacitance values for 500V in 1210 size]																																
	630	[Bar chart showing capacitance values for 630V in 1210 size]																																
	1k	[Bar chart showing capacitance values for 1kV in 1210 size]																																
	2k	[Bar chart showing capacitance values for 2kV in 1210 size]																																
1808 (4520)	2k	[Bar chart showing capacitance values for 2kV in 1808 size]																																
	3k	[Bar chart showing capacitance values for 3kV in 1808 size]																																
1812 (4532)	100	[Bar chart showing capacitance values for 100V in 1812 size]																																
	200	[Bar chart showing capacitance values for 200V in 1812 size]																																
	250	[Bar chart showing capacitance values for 250V in 1812 size]																																
	500	[Bar chart showing capacitance values for 500V in 1812 size]																																
	630	[Bar chart showing capacitance values for 630V in 1812 size]																																
	1k	[Bar chart showing capacitance values for 1kV in 1812 size]																																
	2k	[Bar chart showing capacitance values for 2kV in 1812 size]																																
	3k	[Bar chart showing capacitance values for 3kV in 1812 size]																																
2220 (5750)	100	[Bar chart showing capacitance values for 100V in 2220 size]																																
	200	[Bar chart showing capacitance values for 200V in 2220 size]																																
	250	[Bar chart showing capacitance values for 250V in 2220 size]																																
	500	[Bar chart showing capacitance values for 500V in 2220 size]																																
	630	[Bar chart showing capacitance values for 630V in 2220 size]																																
	1k	[Bar chart showing capacitance values for 1kV in 2220 size]													3.6																			
	2k	[Bar chart showing capacitance values for 2kV in 2220 size]																																
	3k	[Bar chart showing capacitance values for 3kV in 2220 size]																																

Product Line Up (COG)

■ Size : 1.00 X 0.50mm (inch : 0402)

Thickness Max.	Rated Voltage	Capacitance	Capacitance Tolerance	Part Number
0.55mm	100Vdc	1.8pF	±0.25pF	CL05C1R8CC5NNN □
		2.2pF	±0.25pF	CL05C2R2CC5NNN □
		3.0pF	±0.25pF	CL05C030CC5NNN □
		3.3pF	±0.25pF	CL05C3R3CC5NNN □
		4.0pF	±0.25pF	CL05C040CC5NNN □
		15pF	±5%	CL05C150JC5NNN □
		33pF	±5%	CL05C330JC5NNN □
		39pF	±5%	CL05C390JC5NNN □
		47pF	±5%	CL05C470JC5NNN □
		82pF	±5%	CL05C820JC5NNN □
		100pF	±5%	CL05C101JC5NNN □

Thickness Max.	Rated Voltage	Capacitance	Capacitance Tolerance	Part Number
0.90mm	100Vdc	270pF	±5%	CL10C271JC8NNN □
		330pF	±5%	CL10C331JC8NNN □
		390pF	±5%	CL10C391JC8NNN □
		470pF	±5%	CL10C471JC8NNN □
		1.0nF	±5%	CL10C102JC8NNN □
		200Vdc	220pF	±10%
	250Vdc	470pF	±5%	CL10C471JE8NNN □

■ Size : 2.00 X 1.25mm (inch : 0805)

Thickness Max.	Rated Voltage	Capacitance	Capacitance Tolerance	Part Number
0.75mm	100Vdc	2.7pF	±0.25pF	CL21C2R7CCANNN □
		4.7pF	±0.1pF	CL21C4R7BCANNN □
		10pF	±0.25pF	CL21C100CCANNN □
		10pF	±5%	CL21C100JCANNN □
		11pF	±2%	CL21C110GCANNN □
		11pF	±5%	CL21C110JCANNN □
		12pF	±2%	CL21C120GCANNN □
		13pF	±2%	CL21C130GCANNN □
		13pF	±5%	CL21C130JCANNN □
		14pF	±5%	CL21C140JCANNN □
		15pF	±5%	CL21C150JCANNN □
		16pF	±2%	CL21C160GCANNN □
		16pF	±5%	CL21C160JCANNN □
		17pF	±5%	CL21C170JCANNN □
		18pF	±2%	CL21C180GCANNN □
		18pF	±5%	CL21C180JCANNN □
		20pF	±5%	CL21C200JCANNN □
		22pF	±5%	CL21C220JCANNN □
		24pF	±2%	CL21C240GCANNN □
		24pF	±5%	CL21C240JCANNN □
		25pF	±5%	CL21C250JCANNN □
		27pF	±5%	CL21C270JCANNN □
		30pF	±5%	CL21C300JCANNN □
		32pF	±2%	CL21C320GCANNN □
		33pF	±1%	CL21C330FCANNN □
		33pF	±5%	CL21C330JCANNN □
		39pF	±1%	CL21C390FCANNN □
		39pF	±5%	CL21C390JCANNN □
		47pF	±5%	CL21C470JCANNN □
		50pF	±5%	CL21C500JCANNN □
		52pF	±5%	CL21C520JCANNN □
		56pF	±5%	CL21C560JCANNN □
		62pF	±5%	CL21C620JCANNN □
		62pF	±10%	CL21C620KCANNN □
		68pF	±2%	CL21C680GCANNN □
		68pF	±5%	CL21C680JCANNN □
		82pF	±5%	CL21C820JCANNN □
		91pF	±5%	CL21C910JCANNN □
		95pF	±5%	CL21C950JCANNN □
		100pF	±5%	CL21C101JCANNN □
		110pF	±5%	CL21C111JCANNN □
		120pF	±5%	CL21C121JCANNN □
150pF	±5%	CL21C151JCANNN □		
180pF	±5%	CL21C181JCANNN □		
180pF	±10%	CL21C181KCANNN □		
190pF	±5%	CL21C191JCANNN □		
200pF	±5%	CL21C201JCANNN □		
220pF	±5%	CL21C221JCANNN □		
220pF	±10%	CL21C221KCANNN □		

■ Size : 1.60 X 0.80mm (inch : 0603)

Thickness Max.	Rated Voltage	Capacitance	Capacitance Tolerance	Part Number
0.90mm	100Vdc	10pF	±0.25pF	CL10C100CC8NNN □
		10pF	±0.5pF	CL10C100DC8NNN □
		10pF	±5%	CL10C100JC8NNN □
		12pF	±5%	CL10C120JC8NNN □
		13pF	±5%	CL10C130JC8NNN □
		15pF	±5%	CL10C150JC8NNN □
		18pF	±5%	CL10C180JC8NNN □
		20pF	±5%	CL10C200JC8NNN □
		22pF	±5%	CL10C220JC8NNN □
		24pF	±5%	CL10C240JC8NNN □
		27pF	±5%	CL10C270JC8NNN □
		30pF	±5%	CL10C300JC8NNN □
		32pF	±2%	CL10C320GC8NNN □
		33pF	±1%	CL10C330FC8NNN □
		33pF	±5%	CL10C330JC8NNN □
		39pF	±1%	CL10C390FC8NNN □
		39pF	±5%	CL10C390JC8NNN □
		47pF	±5%	CL10C470JC8NNN □
		50pF	±5%	CL10C500JC8NNN □
		52pF	±5%	CL10C520JC8NNN □
		56pF	±5%	CL10C560JC8NNN □
		62pF	±5%	CL10C620JC8NNN □
		62pF	±10%	CL10C620KC8NNN □
		68pF	±2%	CL10C680GC8NNN □
		68pF	±5%	CL10C680JC8NNN □
		82pF	±5%	CL10C820JC8NNN □
		91pF	±5%	CL10C910JC8NNN □
		95pF	±5%	CL10C950JC8NNN □
		100pF	±5%	CL10C101JC8NNN □
		110pF	±5%	CL10C111JC8NNN □
		120pF	±5%	CL10C121JC8NNN □
		150pF	±5%	CL10C151JC8NNN □
180pF	±5%	CL10C181JC8NNN □		
180pF	±10%	CL10C181KC8NNN □		
190pF	±5%	CL10C191JC8NNN □		
200pF	±5%	CL10C201JC8NNN □		
220pF	±5%	CL10C221JC8NNN □		
220pF	±10%	CL10C221KC8NNN □		

※ □ mark means packaging code. If you want to learn the code or quantity in detail, please see p.148

In order to move to the page directly, please click the here. ↑

Medium – High Voltage Capacitors

Product Line Up (COG)

■ Size : 2.00 X 1.25mm (inch : 0805)

Thickness Max.	Rated Voltage	Capacitance	Capacitance Tolerance	Part Number
0.75mm	100Vdc	91pF	±5%	CL21C910JCANNN □
		100pF	±5%	CL21C101JCANNN □
		110pF	±5%	CL21C111JCANNN □
		120pF	±5%	CL21C121JCANNN □
		130pF	±5%	CL21C131JCANNN □
		150pF	±1%	CL21C151FCANNN □
		150pF	±5%	CL21C151JCANNN □
		160pF	±5%	CL21C161JCANNN □
		180pF	±2%	CL21C181GCANNN □
		180pF	±5%	CL21C181JCANNN □
		200pF	±5%	CL21C201JCANNN □
		220pF	±5%	CL21C221JCANNN □
		240pF	±5%	CL21C241JCANNN □
		270pF	±5%	CL21C271JCANNN □
		270pF	±10%	CL21C271KCANNN □
		300pF	±5%	CL21C301JCANNN □
		330pF	±5%	CL21C331JCANNN □
		360pF	±5%	CL21C361JCANNN □
	390pF	±5%	CL21C391JCANNN □	
	200Vdc	100pF	±5%	CL21C101JDCANNN □
0.95mm	100Vdc	15pF	±5%	CL21C150JCCNND □
		470pF	±2%	CL21C471GCCNND □
		470pF	±5%	CL21C471JCCNND □
		510pF	±5%	CL21C511JCCNND □
		560pF	±1%	CL21C561FCCNND □
		620pF	±5%	CL21C621JCCNND □
		680pF	±5%	CL21C681JCCNND □
		200Vdc	10pF	±0.5pF
	15pF	±5%	CL21C150JDCNND □	
	18pF	±2%	CL21C180GDCNND □	
	18pF	±5%	CL21C180JDCNND □	
	20pF	±2%	CL21C200GDCNND □	
	36pF	±2%	CL21C360GDCNND □	
	39pF	±2%	CL21C390GDCNND □	
	43pF	±2%	CL21C430GDCNND □	
	47pF	±5%	CL21C470JDCNND □	
	51pF	±5%	CL21C510JDCNND □	
	56pF	±2%	CL21C560GDCNND □	
	56pF	±5%	CL21C560JDCNND □	
	62pF	±2%	CL21C620GDCNND □	
100pF	±2%	CL21C101GDCNND □		
100pF	±5%	CL21C101JDCNND □		
120pF	±5%	CL21C121JDCNND □		
150pF	±5%	CL21C151JDCNND □		
200pF	±5%	CL21C201JDCNND □		
220pF	±5%	CL21C221JDCNND □		
250Vdc	100pF	±10%	CL21C101KECNND □	
1.35mm	100Vdc	100pF	±5%	CL21C101JCFNND □
		1.0nF	±2%	CL21C102GCFNND □
		1.0nF	±5%	CL21C102JCFNND □
		1.2nF	±5%	CL21C122JCFNND □
		2.2nF	±5%	CL21C222JCFNND □
		200Vdc	470pF	±5%
	1.0nF	±5%	CL21C102JDFNND □	

Thickness Max.	Rated Voltage	Capacitance	Capacitance Tolerance	Part Number
1.35mm	250Vdc	1.0nF	±5%	CL21C102JEFNND □
		27pF	±5%	CL21C270JHFNND □
	630Vdc	33pF	±5%	CL21C330JHFNND □
		68pF	±5%	CL21C680JHFNND □
		150pF	±5%	CL21C151JHFNND □
		560pF	±5%	CL21C561JHFNND □

■ Size : 3.20 X 1.60mm (inch : 1206)

Thickness Max.	Rated Voltage	Capacitance	Capacitance Tolerance	Part Number
1.00mm	100Vdc	10pF	±0.25pF	CL31C100CCNND □
		10pF	±0.5pF	CL31C100DCNND □
		10pF	±5%	CL31C100JCCNND □
		11pF	±5%	CL31C110JCCNND □
		12pF	±2%	CL31C120GCCNND □
		12pF	±5%	CL31C120JCCNND □
		15pF	±2%	CL31C150GCCNND □
		15pF	±5%	CL31C150JCCNND □
		18pF	±2%	CL31C180GCCNND □
		18pF	±5%	CL31C180JCCNND □
		20pF	±5%	CL31C200JCCNND □
		22pF	±5%	CL31C220JCCNND □
		24pF	±5%	CL31C240JCCNND □
		27pF	±1%	CL31C270FCCNND □
		27pF	±2%	CL31C270GCCNND □
		27pF	±5%	CL31C270JCCNND □
		30pF	±2%	CL31C300GCCNND □
		30pF	±5%	CL31C300JCCNND □
		30pF	±10%	CL31C300KCCNND □
		33pF	±5%	CL31C330JCCNND □
		36pF	±5%	CL31C360JCCNND □
		39pF	±5%	CL31C390JCCNND □
		43pF	±5%	CL31C430JCCNND □
		51pF	±5%	CL31C510JCCNND □
		56pF	±5%	CL31C560JCCNND □
		62pF	±5%	CL31C620JCCNND □
		68pF	±5%	CL31C680JCCNND □
		75pF	±5%	CL31C750JCCNND □
		82pF	±5%	CL31C820JCCNND □
		91pF	±1%	CL31C910FCCNND □
		91pF	±2%	CL31C910GCCNND □
		91pF	±5%	CL31C910JCCNND □
		100pF	±5%	CL31C101JCCNND □
		110pF	±5%	CL31C111JCCNND □
		120pF	±5%	CL31C121JCCNND □
		130pF	±5%	CL31C131JCCNND □
		180pF	±1%	CL31C181FCCNND □
		180pF	±5%	CL31C181JCCNND □
		200pF	±5%	CL31C201JCCNND □
		220pF	±5%	CL31C221JCCNND □
240pF	±5%	CL31C241JCCNND □		
270pF	±5%	CL31C271JCCNND □		
300pF	±5%	CL31C301JCCNND □		

※ □ mark means packaging code. If you want to learn the code or quantity in detail, please see p.148
 In order to move to the page directly, please click the here. †

Product Line Up (COG)

■ Size : 3.20 X 1.60mm (inch : 1206)

Thickness Max.	Rated Voltage	Capacitance	Capacitance Tolerance	Part Number	Remark	Thickness Max.	Rated Voltage	Capacitance	Capacitance Tolerance	Part Number	Remark	
1.00mm	100Vdc	330pF	±1%	CL31C331FCCNNN□		1.40mm	500Vdc	470pF	±10%	CL31C471KGFNNN□		
		330pF	±5%	CL31C331JCCNNN□				560pF	±2%	CL31C561JGFNNN□		
		360pF	±5%	CL31C361JCCNNN□				560pF	±5%	CL31C561JGFNNN□		
		390pF	±5%	CL31C391JCCNNN□				630Vdc	10pF	±5%	CL31C100JHFNNN□	
		390pF	±10%	CL31C391KCCNNN□					12pF	±5%	CL31C120JHFNNN□	
		470pF	±1%	CL31C471FCCNNN□					15pF	±5%	CL31C150JHFNNN□	
		470pF	±2%	CL31C471GCCNNN□					18pF	±5%	CL31C180JHFNNN□	
		470pF	±5%	CL31C471JCCNNN□					22pF	±5%	CL31C220JHFNNN□	
		470pF	±10%	CL31C471KCCNNN□					22pF	±5%	CL31C220JHFNNC□	dv/dt
		510pF	±5%	CL31C511JCCNNN□					27pF	±5%	CL31C270JHFNNN□	
		560pF	±5%	CL31C561JCCNNN□			33pF		±5%	CL31C330JHFNNN□		
		680pF	±5%	CL31C681JCCNNN□			39pF		±5%	CL31C390JHFNNN□		
		750pF	±5%	CL31C751JCCNNN□			47pF		±2%	CL31C470GHFNNN□		
		820pF	±1%	CL31C821FCCNNN□			47pF	±5%	CL31C470JHFNNN□			
		910pF	±5%	CL31C911JCCNNN□			47pF	±5%	CL31C470JHFNNC□	dv/dt		
		1.0nF	±5%	CL31C102JCCNNN□			47pF	±10%	CL31C470KHFNNN□			
		1.2nF	±5%	CL31C122JCCNNN□			56pF	±5%	CL31C560JHFNNN□			
		1.5nF	±5%	CL31C152JCCNNN□			68pF	±5%	CL31C680JHFNNN□			
		1.8nF	±5%	CL31C182JCCNNN□			82pF	±5%	CL31C820JHFNNN□			
		2.2nF	±5%	CL31C222JCCNNN□			100pF	±5%	CL31C101JHFNNN□			
	200Vdc	10pF	±0.5pF	CL31C100DDCNNN□			120pF	±5%	CL31C121JHFNNN□			
		15pF	±5%	CL31C150JDCNNN□			150pF	±5%	CL31C151JHFNNN□			
		36pF	±5%	CL31C360JDCNNN□			180pF	±5%	CL31C181JHFNNN□			
		51pF	±5%	CL31C510JDCNNN□			220pF	±5%	CL31C221JHFNNN□			
		100pF	±5%	CL31C101JDCNNN□			220pF	±10%	CL31C221KHFNNN□			
		200pF	±5%	CL31C201JDCNNN□			330pF	±5%	CL31C331JHFNNN□			
		220pF	±5%	CL31C221JDCNNN□			390pF	±5%	CL31C391JHFNNN□			
		470pF	±5%	CL31C470JHFNNN□			470pF	±5%	CL31C471JHFNNN□			
1.30mm	630Vdc	1.0nF	±5%	CL31C102JHMLNN□		1kVdc	10pF	±5%	CL31C100JIFNNN□			
1.40mm	200Vdc	1.0nF	±5%	CL31C102JDFNNN□			12pF	±5%	CL31C120JIFNNN□			
		1.5nF	±5%	CL31C152JDFNNN□			15pF	±5%	CL31C150JIFNNN□			
	500Vdc	10pF	±5%	CL31C100JGFNNN□			18pF	±5%	CL31C180JIFNNN□			
		15pF	±2%	CL31C150GGFNNN□			22pF	±5%	CL31C220JIFNNN□			
		15pF	±5%	CL31C150JGFNNN□			33pF	±5%	CL31C330JIFNNN□			
		20pF	±5%	CL31C200JGFNNN□			39pF	±5%	CL31C390JIFNNN□			
		22pF	±5%	CL31C220JGFNNN□			47pF	±5%	CL31C470JIFNNN□			
		39pF	±2%	CL31C390GGFNNN□			56pF	±5%	CL31C560JIFNNN□			
		39pF	±5%	CL31C390JGFNNN□			68pF	±5%	CL31C680JIFNNN□			
		47pF	±2%	CL31C470GGFNNN□			82pF	±5%	CL31C820JIFNNN□			
		47pF	±5%	CL31C470JGFNNN□			100pF	±5%	CL31C101JIFNNN□			
		68pF	±2%	CL31C680GGFNNN□			100pF	±5%	CL31C101JIFNNC□	dv/dt		
		68pF	±5%	CL31C680JGFNNN□			120pF	±5%	CL31C121JIFNNN□			
		82pF	±5%	CL31C820JGFNNN□			150pF	±5%	CL31C151JIFNNN□			
		100pF	±2%	CL31C101GGFNNN□			470pF	±5%	CL31C471JIFNNN□			
		100pF	±5%	CL31C101JGFNNN□			1.80mm	100Vdc	3.9nF	±5%	CL31C392JCHNNN□	
		100pF	±10%	CL31C101KGFNNN□					4.7nF	±5%	CL31C472JCHNNN□	
		150pF	±5%	CL31C151JGFNNN□					10nF	±5%	CL31C103JCHNNN□	
		220pF	±2%	CL31C221GGFNNN□				200Vdc	2.2nF	±5%	CL31C222JDHNNN□	
		220pF	±5%	CL31C221JGFNNN□					2.2nF	±10%	CL31C222KDHNNN□	
220pF	±10%	CL31C221KGFNNN□		250Vdc	2.2nF				±5%	CL31C222JEHNNN□		
270pF	±2%	CL31C271GGFNNN□			3.9nF			±5%	CL31C392JEHNNN□			
270pF	±5%	CL31C271JGFNNN□			4.7nF			±5%	CL31C472JEHNNN□			
330pF	±5%	CL31C331JGFNNN□			5.6nF			±5%	CL31C562JEHNNN□			
470pF	±2%	CL31C471GGFNNN□		6.8nF	±5%			CL31C682JEHNNN□				
470pF	±5%	CL31C471JGFNNN□										

※ □ mark means packaging code. If you want to learn the code or quantity in detail, please see p.148

In order to move to the page directly, please click the here. ↑

Medium – High Voltage Capacitors

Product Line Up (COG)

■ Size : 3.20 X 1.60mm (inch : 1206)

Thickness Max.	Rated Voltage	Capacitance	Capacitance Tolerance	Part Number	Remark	
1.80mm	250Vdc	8.2nF	±5%	CL31C822JEHNNN□		
		500Vdc	1.0nF	±2%	CL31C102JGHNNN□	
			1.0nF	±5%	CL31C102JGHNNN□	
			1.5nF	±5%	CL31C152JGHNNN□	
			2.2nF	±5%	CL31C222JGHNNN□	
	630Vdc	680pF	±5%	CL31C681JHHNNN□		
		1.0nF	±5%	CL31C102JHHNNN□		
		1.0nF	±5%	CL31C102JHHNNC□	dv/dt	
		1.2nF	±5%	CL31C122JHHNNN□		
		1.5nF	±5%	CL31C152JHHNNN□		
		2.2nF	±5%	CL31C222JHHNNN□		
		2.7nF	±5%	CL31C272JHHNNN□		
		3.3nF	±5%	CL31C332JHHNNN□		
		1kVdc	33pF	±5%	CL31C330JHHNNN□	
	150pF		±5%	CL31C151JHHNNN□		
	180pF		±5%	CL31C181JHHNNN□		
	220pF		±5%	CL31C221JHHNNN□		
	220pF		±5%	CL31C221JHHNNC□	dv/dt	
	270pF		±5%	CL31C271JHHNNN□		
	270pF		±5%	CL31C271JHHNNC□	dv/dt	
330pF	±5%		CL31C331JHHNNN□			
330pF	±5%		CL31C331JHHNNC□	dv/dt		
470pF	±5%		CL31C471JHHNNN□			
470pF	±5%		CL31C471JHHNNC□	dv/dt		
2kVdc	10pF	±5%	CL31C100JHHNNN□			
	10pF	±5%	CL31C100JHHNNC□	dv/dt		
	15pF	±5%	CL31C150JHHNNN□			
	22pF	±5%	CL31C220JHHNNN□			
	33pF	±5%	CL31C330JHHNNN□			
	47pF	±5%	CL31C470JHHNNN□			
	47pF	±5%	CL31C470JHHNNC□	dv/dt		
	68pF	±5%	CL31C680JHHNNN□			
	100pF	±5%	CL31C101JHHNNN□			

■ Size : 4.50 X 2.00mm (inch : 1808)

Thickness Max.	Rated Voltage	Capacitance	Capacitance Tolerance	Part Number	Remark
1.45mm	3kVdc	5pF	±5%	CL42C050JKFNNN□	
		10pF	±5%	CL42C100JKFNNN□	
		12pF	±5%	CL42C120JKFNNN□	
		15pF	±5%	CL42C150JKFNNN□	
		18pF	±5%	CL42C180JKFNNN□	
		22pF	±5%	CL42C220JKFNNN□	
		27pF	±5%	CL42C270JKFNNN□	
		33pF	±5%	CL42C330JKFNNN□	
		47pF	±5%	CL42C470JKFNNN□	
		68pF	±5%	CL42C680JKFNNN□	
		100pF	±5%	CL42C101JKFNNN□	
1.80mm	2kVdc	220pF	±5%	CL42C221JHHNNN□	
2.20mm	3kVdc	150pF	±5%	CL42C151JKINNN□	

■ Size : 4.50 X 3.20mm (inch : 1812)

Thickness Max.	Rated Voltage	Capacitance	Capacitance Tolerance	Part Number	Remark
1.45mm	100Vdc	10nF	±5%	CL43C103JCFNNN□	
1.80mm	1kVdc	820pF	±5%	CL43C821JHHNNN□	
		1.0nF	±5%	CL43C102JHHNNN□	
2.20mm	1kVdc	1.2nF	±5%	CL43C122JHHNNN□	
2.70mm	630Vdc	22nF	±5%	CL43C223JHHNNN□	
		1kVdc	1.3nF	±5%	CL43C132JHHNNN□
	1.5nF	±5%	CL43C152JHHNNN□		
	1.6nF	±5%	CL43C162JHHNNN□		
	1.8nF	±5%	CL43C182JHHNNN□		

■ Size : 5.70 X 5.00mm (inch : 2220)

Thickness Max.	Rated Voltage	Capacitance	Capacitance Tolerance	Part Number	Remark
2.70mm	3kVdc	1.0nF	±5%	CL55C102JKJNNN□	

■ Size : 3.20 X 2.50mm (inch : 1210)

Thickness Max.	Rated Voltage	Capacitance	Capacitance Tolerance	Part Number	Remark	
1.45mm	100Vdc	1.0nF	±10%	CL32C102KCFNNN□		
		1.5nF	±10%	CL32C152KCFNNN□		
		4.7nF	±5%	CL32C472JCFNNN□		
	500Vdc	680pF	±5%	CL32C681JGFNNN□		
		1kVdc	330pF	±5%	CL32C331JIFNNN□	
		2kVdc	100pF	±5%	CL32C101JHFNNN□	
			100pF	±10%	CL32C101KJFNNN□	
			150pF	±5%	CL32C151JHFNNN□	
1.80mm	630Vdc	1.8nF	±5%	CL32C182JHHNNN□		
	1kVdc	470pF	±5%	CL32C471JHHNNN□		
	2kVdc	220pF	±5%	CL32C221JHHNNN□		
2.20mm	2kVdc	330pF	±5%	CL32C331JHHNNN□		
2.70mm	630Vdc	6.8nF	±10%	CL32C682KHJNNN□		
		8.2nF	±5%	CL32C822JHHNNN□		
	2kVdc	470pF	±5%	CL32C471JHHNNN□		

※ □ mark means packaging code. If you want to learn the code or quantity in detail, please see p.148

In order to move to the page directly, please click the here. ↑

Product Line Up (X7R)

■ Size : 1.60 X 0.80mm (inch : 0603)

Thickness Max.	Rated Voltage	Capacitance	Capacitance Tolerance	Part Number	Remark
0.90mm	100Vdc	220pF	±10%	CL10B221KC8N [□]	
		470pF	±10%	CL10B471KC8N [□]	
		680pF	±5%	CL10B681JC8N [□]	
		1.0nF	±10%	CL10B102KC8N [□]	
		1.5nF	±10%	CL10B152KC8N [□]	
		1.8nF	±10%	CL10B182KC8N [□]	
		2.2nF	±10%	CL10B222KC8N [□]	
		2.7nF	±10%	CL10B272KC8N [□]	
		3.3nF	±5%	CL10B332JC8N [□]	
		3.3nF	±10%	CL10B332KC8N [□]	
		3.9nF	±10%	CL10B392KC8N [□]	
		4.7nF	±10%	CL10B472KC8N [□]	
		10nF	±10%	CL10B103KC8N [□]	
		100nF	±10%	CL10B104KC8N [□]	

Thickness Max.	Rated Voltage	Capacitance	Capacitance Tolerance	Part Number	Remark
1.35mm	100Vdc	100nF	±10%	CL21B104KCFN [□]	
		220nF	±10%	CL21B224KCFN [□]	
	250Vdc	4.7nF	±10%	CL21B472KEFN [□]	
		10nF	±10%	CL21B103KEFN [□]	
		15nF	±10%	CL21B153KEFN [□]	

■ Size : 3.20 X 1.60mm (inch : 1206)

Thickness Max.	Rated Voltage	Capacitance	Capacitance Tolerance	Part Number	Remark	
1.00mm	100Vdc	330pF	±10%	CL31B331KCCN [□]		
		470pF	±10%	CL31B471KCCN [□]		
		1.0nF	±10%	CL31B102KCCN [□]		
		1.5nF	±10%	CL31B152KCCN [□]		
		2.2nF	±10%	CL31B222KCCN [□]		
		2.7nF	±5%	CL31B272JCCN [□]		
		3.3nF	±10%	CL31B332KCCN [□]		
		3.9nF	±10%	CL31B392KCCN [□]		
		4.7nF	±10%	CL31B472KCCN [□]		
		6.8nF	±10%	CL31B682KCCN [□]		
		10nF	±10%	CL31B103KCCN [□]		
		18nF	±10%	CL31B183KCCN [□]		
		22nF	±10%	CL31B223KCCN [□]		
		33nF	±10%	CL31B333KCCN [□]		
		47nF	±5%	CL31B473JCCN [□]		
		47nF	±10%	CL31B473KCCN [□]		
		47nF	±20%	CL31B473MCCN [□]		
		200Vdc	470pF	±10%	CL31B471KDCN [□]	
	680pF		±10%	CL31B681KDCN [□]		
	1.0nF		±10%	CL31B102KDCN [□]		
	2.2nF		±10%	CL31B222KDCN [□]		
	3.3nF		±10%	CL31B332KDCN [□]		
	4.7nF		±10%	CL31B472KDCN [□]		
	6.8nF		±10%	CL31B682KDCN [□]		
	8.2nF		±10%	CL31B822KDCN [□]		
	10nF		±5%	CL31B103JCCN [□]		
	10nF		±10%	CL31B103KDCN [□]		
	15nF		±10%	CL31B153KDCN [□]		
	18nF		±10%	CL31B183KDCN [□]		
	22nF		±5%	CL31B223JDCN [□]		
	22nF		±10%	CL31B223KDCN [□]		
	22nF		±10%	CL31B223KDCN [□]		
	1.40mm		100Vdc	470pF	±10%	CL31B471KCFN [□]
		100nF		±5%	CL31B104JCFN [□]	
100nF		±10%		CL31B104KCFN [□]		
200Vdc		33nF	±10%	CL31B333KDFN [□]		
		47nF	±10%	CL31B473KDFN [□]		
250Vdc		22nF	±10%	CL31B223KEFN [□]		
		500Vdc	220pF	±10%	CL31B221KGFN [□]	
			470pF	±10%	CL31B471KGFN [□]	
			470pF	±20%	CL31B471MGFN [□]	
			560pF	±10%	CL31B561KGFN [□]	
100Vdc	680pF	±10%	CL31B681KGFN [□]			
	1.0nF	±10%	CL31B102KGFN [□]			
	1.0nF	±20%	CL31B102MGFN [□]			
	1.5nF	±10%	CL31B152KGFN [□]			
	1.8nF	±5%	CL31B182JGFN [□]			

■ Size : 2.00 X 1.25mm (inch : 0805)

Thickness Max.	Rated Voltage	Capacitance	Capacitance Tolerance	Part Number	Remark
0.75mm	100Vdc	100pF	±5%	CL21B101JCANN [□]	
		220pF	±10%	CL21B221KCAN [□]	
		270pF	±10%	CL21B271KCAN [□]	
		330pF	±5%	CL21B331JCANN [□]	
		330pF	±10%	CL21B331KCAN [□]	
		470pF	±10%	CL21B471KCAN [□]	
		1.0nF	±5%	CL21B102JCAN [□]	
		1.0nF	±10%	CL21B102KCAN [□]	
		1.5nF	±10%	CL21B152KCAN [□]	
		2.2nF	±10%	CL21B222KCAN [□]	
		3.3nF	±10%	CL21B332KCAN [□]	
		3.9nF	±10%	CL21B392KCAN [□]	
		4.7nF	±10%	CL21B472KCAN [□]	
		6.8nF	±10%	CL21B682KCAN [□]	
		8.2nF	±10%	CL21B822KCAN [□]	
		10nF	±5%	CL21B103JCAN [□]	
		10nF	±10%	CL21B103KCAN [□]	
		0.95mm	100Vdc	15nF	±10%
330pF	±10%			CL21B331KDCN [□]	
470pF	±10%			CL21B471KDCN [□]	
560pF	±10%			CL21B561KDCN [□]	
1.0nF	±5%			CL21B102JDCN [□]	
1.0nF	±10%			CL21B102KDCN [□]	
1.5nF	±10%			CL21B152KDCN [□]	
200Vdc	2.2nF		±10%	CL21B222KDCN [□]	
	3.3nF		±10%	CL21B332KDCN [□]	
	4.7nF		±10%	CL21B472KDCN [□]	
	6.8nF		±10%	CL21B682KDCN [□]	
	10nF		±10%	CL21B103KDCN [□]	
	10nF		±10%	CL21B103KDCN [□]	
	560pF		±10%	CL21B561KECN [□]	
1.35mm	100Vdc	22nF	±10%	CL21B223KCFN [□]	
		27nF	±10%	CL21B273KCFN [□]	
		33nF	±10%	CL21B333KCFN [□]	
		47nF	±10%	CL21B473KCFN [□]	
		68nF	±10%	CL21B683KCFN [□]	

※ □ mark means packaging code. If you want to learn the code or quantity in detail, please see p.148
In order to move to the page directly, please click the here. ↑

Medium – High Voltage Capacitors

Product Line Up (X7R)

■ Size : 3.20 X 1.60mm (inch : 1206)

■ Size : 3.20 X 2.50mm (inch : 1210)

Thickness Max.	Rated Voltage	Capacitance	Capacitance Tolerance	Part Number	Remark	
1.40mm	500Vdc	1.8nF	±10%	CL31B182KGFNNN□		
		2.2nF	±10%	CL31B222KGFNNN□		
		2.2nF	±20%	CL31B222MGFNNN□		
		2.7nF	±10%	CL31B272KGFNNN□		
		3.3nF	±10%	CL31B332KGFNNN□		
		4.7nF	±10%	CL31B472KGFNNN□		
		6.8nF	±10%	CL31B682KGFNNN□		
		8.2nF	±10%	CL31B822KGFNNN□		
		10nF	±10%	CL31B103KGFNNN□		
		12nF	±10%	CL31B123KGFNNN□		
		15nF	±10%	CL31B153KGFNNN□		
		630Vdc	220pF	±10%	CL31B221KHFNNN□	
			330pF	±10%	CL31B331KHFNNN□	
	470pF		±10%	CL31B471KHFNNN□		
	560pF		±10%	CL31B561KHFNNN□		
	680pF		±10%	CL31B681KHFNNN□		
	1.0nF		±10%	CL31B102KHFNNN□		
	1.5nF		±10%	CL31B152KHFNNN□		
	2.2nF		±10%	CL31B222KHFNNN□		
	3.3nF		±10%	CL31B332KHFNNN□		
	4.7nF		±10%	CL31B472KHFNNN□		
	6.8nF		±10%	CL31B682KHFNNN□		
	8.2nF		±5%	CL31B822JHFNNN□		
	1kVdc	10nF	±10%	CL31B103KHFNNN□		
		15nF	±10%	CL31B153KHFNNN□		
		680pF	±10%	CL31B681KIFNNN□	Derating	
		1.0nF	±10%	CL31B102KIFNNN□	Derating	
		2.2nF	±10%	CL31B222KIFNNN□	Derating	
		2.5nF	±10%	CL31B252KIFNNN□	Derating	
	1.80mm	100Vdc	3.3nF	±5%	CL31B332JIFNNN□	Derating
			4.7nF	±10%	CL31B472KIFNNN□	Derating
			150nF	±10%	CL31B154KCHNNN□	
			220nF	±10%	CL31B224KCHNNN□	
		200Vdc	68nF	±10%	CL31B683KDHNNN□	
			100nF	±10%	CL31B104KDHNNN□	
		250Vdc	33nF	±10%	CL31B333KEHNNN□	
39nF			±10%	CL31B393KEHNNN□		
47nF			±10%	CL31B473KEHNNN□		
500Vdc		100nF	±10%	CL31B104KEHNNN□		
	33nF	±10%	CL31B333KGHNNN□			
630Vdc	220pF	±10%	CL31B221KJHNNN□	Derating		
		±10%	CL31B471KJHNNN□	Derating		
	470pF	±10%	CL31B102KJHNNN□	Derating		
		±20%	CL31B102MJHNNN□	Derating		
	1.0nF	±10%	CL31B152KJHNNN□	Derating		
		±10%	CL31B152KJHNNN□	Derating		

Thickness Max.	Rated Voltage	Capacitance	Capacitance Tolerance	Part Number	Remark	
1.45mm	100Vdc	2.2nF	±10%	CL32B222KCFNNN□		
		4.7nF	±10%	CL32B472KCFNNN□		
		10nF	±10%	CL32B103KCFNNN□		
		47nF	±10%	CL32B473KCFNNN□		
		100nF	±5%	CL32B104JCFNNN□		
		100nF	±10%	CL32B104KCFNNN□		
		150nF	±10%	CL32B154KCFNNN□		
		200Vdc	10nF	±10%	CL32B103KDFNNN□	
	500Vdc		1.8nF	±5%	CL32B182JGFNNN□	
			10nF	±10%	CL32B103KGFNNN□	
			10nF	±20%	CL32B103MGFNNN□	
	630Vdc	15nF	±20%	CL32B153MGFNNN□		
		22nF	±10%	CL32B223KGFNNN□		
		4.7nF	±20%	CL32B472MHFNNN□		
		1kVdc	4.7nF	±10%	CL32B472KIFNNN□	Derating
		2kVdc	1.0nF	±10%	CL32B102KJFNNN□	
			1.80mm	100Vdc	220nF	±5%
	220nF	±10%			CL32B224KCHNNN□	
	250Vdc	330nF		±10%	CL32B334KCHNNN□	
		47nF		±10%	CL32B473KEHNNN□	
500Vdc	47nF	±10%	CL32B473KGHNNN□			
	630Vdc	33nF	±10%	CL32B333KHNNN□		
2.20mm	100Vdc	330nF	±10%	CL32B334KCHNNN□		
		470nF	±10%	CL32B474KCHNNN□		
2.70mm	100Vdc	430nF	±10%	CL32B434KJNNN□		
		430nF	±20%	CL32B434MCJNNN□		
		470nF	±10%	CL32B474KJNNN□		
	250Vdc	1.0uF	±10%	CL32B105KJNNN□		
		100nF	±10%	CL32B104KEJNNN□		
		150nF	±10%	CL32B154KEJNNN□		

※ □ mark means packaging code. If you want to learn the code or quantity in detail, please see p.148
 In order to move to the page directly, please click the here. ↑

Product Line Up (X7R)

■ Size : 4.50 X 2.00mm (inch : 1808)

Thickness Max.	Rated Voltage	Capacitance	Capacitance Tolerance	Part Number	Remark
1.45mm	1kVdc	1.0nF	±10%	CL42B102KIFNNN □	Derating
	2kVdc	1.0nF	±10%	CL42B102KJFNNN □	Derating

■ Size : 5.70 X 5.00mm (inch : 2220)

Thickness Max.	Rated Voltage	Capacitance	Capacitance Tolerance	Part Number	Remark
1.80mm	100Vdc	820nF	±10%	CL55B824KCHNNN □	
	2kVdc	10nF	±10%	CL55B103KJHNNN □	Derating
2.70mm	100Vdc	470nF	±10%	CL55B474KCJNNN □	
		2.2uF	±10%	CL55B225KCJNNN □	
		3.3uF	±10%	CL55B335KCJNNN □	
		4.7uF	±10%	CL55B475KCJNNN □	
	630Vdc	220nF	±10%	CL55B224KHJNNN □	

■ Size : 4.50 X 3.20mm (inch : 1812)

Thickness Max.	Rated Voltage	Capacitance	Capacitance Tolerance	Part Number	Remark	
1.45mm	100Vdc	100nF	±10%	CL43B104KCFNNN □		
		100nF	±20%	CL43B104MCFNNN □		
		220nF	±10%	CL43B224KCFNNN □		
		330nF	±10%	CL43B334KCFNNN □		
	200Vdc	1.0nF	±10%	CL43B102KDFNNN □		
		47nF	±10%	CL43B473KDFNNN □		
		47nF	±20%	CL43B473MDFNNN □		
	500Vdc	100nF	±10%	CL43B104KDFNNN □		
		3.3nF	±10%	CL43B332KGFNNN □		
		10nF	±10%	CL43B103KGFNNN □		
		22nF	±10%	CL43B223KGFNNN □		
	500Vdc	33nF	±10%	CL43B333KGFNNN □		
		47nF	±10%	CL43B473KGFNNN □		
		1kVdc	1.0nF	±10%	CL43B102KIFNNN □	Derating
			1.5nF	±10%	CL43B152KIFNNN □	Derating
	2.2nF		±10%	CL43B222KIFNNN □	Derating	
	2.7nF		±10%	CL43B272KIFNNN □	Derating	
	3.3nF		±10%	CL43B332KIFNNN □	Derating	
	4.7nF		±10%	CL43B472KIFNNN □	Derating	
	5.0nF		±10%	CL43B502KIFNNN □	Derating	
	10nF		±10%	CL43B103KIFNNN □	Derating	
	10nF	±20%	CL43B103MIFNNN □	Derating		
	2kVdc	1.0nF	±10%	CL43B102KJFNNN □	Derating	
		1.5nF	±10%	CL43B152KJFNNN □	Derating	
2.2nF		±10%	CL43B222KJFNNN □	Derating		
1.80mm	100Vdc	470nF	±10%	CL43B474KCHNNN □		
		470nF	±20%	CL43B474MCHNNN □		
2.20mm	500Vdc	100nF	±10%	CL43B104KGINNN □		
2.70mm	100Vdc	680nF	±10%	CL43B684KCJNNN □		
		820nF	±10%	CL43B824KCJNNN □		
		1.0uF	±10%	CL43B105KCJNNN □		
	200Vdc	470nF	±10%	CL43B474KDJNNN □		
		250Vdc	220nF	±10%	CL43B224KEJNNN □	
			220nF	±20%	CL43B224MEJNNN □	
		470nF	±10%	CL43B474KEJNNN □		

※ □ mark means packaging code. If you want to learn the code or quantity in detail, please see p.148
In order to move to the page directly, please click the here. ↑

Soft – term Capacitors

Feature



- Soft – Termination relaxes the applied thermal/mechanical stresses by ductile properties of metal–polymer composites.
- Excellent bending strength
- Durability against thermal shock / cycles.

Application

- Mobile Phone
- DC – DC Converter
- Tablet devices
- PC (Laptop, Desktop)
- HDD / SSD board
- Display

Structure and Dimensions

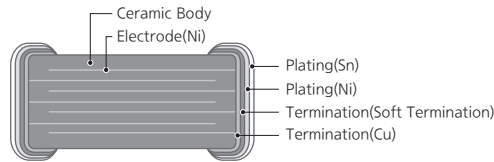
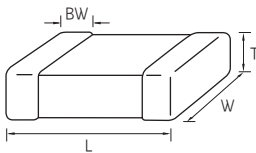

Size Code	EIA Code	Dimension(mm)				
		L	W	T	Thickness Code	BW
03	0201	0.60±0.03	0.30±0.03	0.30±0.03	3	0.15±0.05
05	0402	1.00±0.05	0.50±0.05	0.50±0.05	5	0.25±0.10
		1.00±0.05	0.50±0.05	0.60±0.10	6	
		1.00±0.05	0.50±0.05	0.70±0.10	7	
10	0603	1.60±0.10	0.80±0.10	0.80±0.10	8	0.30±0.20
21	0805	2.00±0.10	1.25±0.10	0.60±0.10	6	0.50+0.2/-0.3
		2.00±0.10	1.25±0.10	0.85±0.10	C	
		2.00±0.10	1.25±0.10	1.25±0.10	F	
		2.00±0.15	1.25±0.15	1.25±0.15	Q	
		2.00±0.20	1.25±0.20	1.25±0.20	Y	
31	1206	3.20±0.15	1.60±0.15	0.85±0.15	C	0.50±0.30
		3.20±0.15	1.60±0.15	1.10±0.15	E	
		3.20±0.15	1.60±0.15	1.25±0.15	F	
		3.20±0.20	1.60±0.20	1.60±0.20	H	
		3.20±0.15	1.60±0.15	1.15±0.10	P	

Soft – term Capacitance Table (X5R)

Size inch (mm)	Rated Voltage (Vdc)	Capacitance																		
		nF						uF												
		100	150	220	330	470	680	1.0	1.5	2.2	3.3	4.7	6.8	10	15	22	33	47	68	100
0201 (0603)	6.3																			
	10																			
0402 (1005)	6.3																			
	10																			
0603 (1608)	6.3																			
	10																			
1206(3216)	25																			

Soft – term Capacitance Table (X7R)

Size inch (mm)	Rated Voltage (Vdc)	Capacitance																				
		nF												uF								
		1.0	1.5	6.8	10	15	22	33	47	68	100	150	220	330	470	680	1.0	1.5	2.2	3.3	4.7	6.8
0805(2012)	250																					
1206 (3216)	25																					
	50																					
	100																					
	250																					
	350																					
1210 (3225)	35																					
	50																					
	100																					

Soft – term Capacitors

Product Line Up (X5R)

■ Size : 0.60 X 0.30mm (inch : 0201)

Thickness Max.	Rated Voltage	Capacitance	Capacitance Tolerance	Part Number	Remark
0.33mm	10Vdc	100nF	±10%	CL03A104KP3ZNN □	Derating
0.35mm	6.3Vdc	1.0uF	±20%	CL03A105MQ3ZSN □	Derating Ref
	10Vdc	1.0uF	±20%	CL03A105MP3ZSN □	Derating Ref
0.39mm	6.3Vdc	2.2uF	±20%	CL03A225MQ3ZRN □	Derating Ref

■ Size : 1.00 X 0.50mm (inch : 0402)

Thickness Max.	Rated Voltage	Capacitance	Capacitance Tolerance	Part Number	Remark
0.57mm	10Vdc	2.2uF	±10%	CL05A225KP5ZSN □	Derating Ref
0.65mm	6.3Vdc	4.7uF	±20%	CL05A475MQ5ZRN □	Derating Ref
	10Vdc	4.7uF	±10%	CL05A475KP5ZRN □	Derating Ref
0.70mm	6.3Vdc	10uF	±20%	CL05A106MQ5ZUN □	Derating Ref
	10Vdc	10uF	±20%	CL05A106MP5ZUN □	Derating Ref
0.80mm	6.3Vdc	22uF	±20%	CL05A226MQ6ZUN □	Derating
0.90mm	6.3Vdc	22uF	±20%	CL05A226MQ7ZUN □	Derating

■ Size : 1.60 X 0.80mm (inch : 0603)

Thickness Max.	Rated Voltage	Capacitance	Capacitance Tolerance	Part Number	Remark
0.95mm	6.3Vdc	10uF	±20%	CL10A106MQ8ZQN □	Ref
1.05mm	6.3Vdc	22uF	±20%	CL10A226MQ8ZUN □	Derating
	10Vdc	22uF	±20%	CL10A226MP8ZUN □	Derating

■ Size : 3.20 X 1.60mm (inch : 1206)

Thickness Max.	Rated Voltage	Capacitance	Capacitance Tolerance	Part Number	Remark
1.80mm	25Vdc	22uF	±10%	CL31A226KAHSNN □	
		22uF	±10%	CL31A226KAHZNN □	

Product Line Up (X7R)

■ Size : 2.00 X 1.25mm (inch : 0805)

Thickness Max.	Rated Voltage	Capacitance	Capacitance Tolerance	Part Number	Remark
0.95mm	250Vdc	1.0nF	±10%	CL21B102KECSNN □	

■ Size : 3.20 X 1.60mm (inch : 1206)

Thickness Max.	Rated Voltage	Capacitance	Capacitance Tolerance	Part Number	Remark
1.00mm	350Vdc	10nF	±10%	CL31B103KFCSSNN □	
		22nF	±10%	CL31B223KFCSSNN □	
1.25mm	350Vdc	33nF	±10%	CL31B333KFESNN □	
1.80mm	25Vdc	10uF	±10%	CL31B106KAHSNN □	
		50Vdc	1.0uF	±10%	CL31B105KBHSNN □
	100Vdc	220nF	±10%	CL31B224KCHSNN □	
		1.0uF	±10%	CL31B105KCHSNN □	
		2.2uF	±10%	CL31B225KCHSNN □	
250Vdc	100nF	±10%	CL31B104KEHSNN □		

■ Size : 3.20 X 2.50mm (inch : 1210)

Thickness Max.	Rated Voltage	Capacitance	Capacitance Tolerance	Part Number	Remark
2.00mm	35Vdc	4.7uF	±10%	CL32B475KLUYNN □	
	50Vdc	4.7uF	±10%	CL32B475KBUYNN □	
2.70mm	100Vdc	1.0uF	±10%	CL32B105KCSNN □	
		2.2uF	±10%	CL32B225KCSNN □	

※ □ mark means packaging code. If you want to learn the code or quantity in detail, please see p.148
In order to move to the page directly, please click the here. ↑

Low Acoustic Noise Capacitor

Feature



- Equivalent electrical characteristics as general products.
- Reduced acoustic noise due to the thick bottom cover.
- Pin-to-pin replacement without changing the substrate land pattern.

Application

- PAM (GSM / TD-SCDMA / TDD-LTE)
- PMIC
- DC-DC Converter
- Tablet devices
- PC (Laptop, Desktop)
- HDD / SSD board

Structure and Dimensions

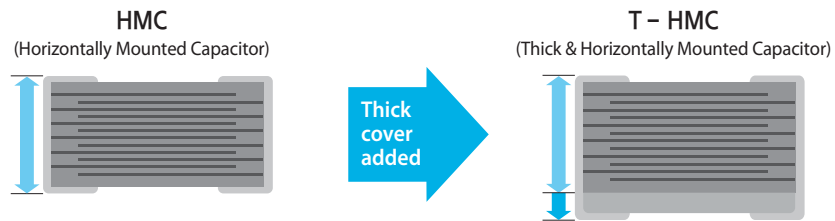

Structure (Size & Thickness)

Same Dielectric Thickness
as Standard MLCC
Normal Bottom Cover

Same Dielectric Thickness
as Standard MLCC
Thick Bottom Cover

Performance

Acoustic Noise Reduction
without Changing Layout

Significant Acoustic Noise Reduction
without Changing Layout

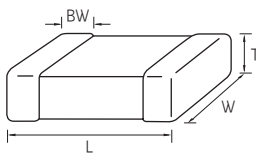

Size Code	EIA Code	Dimension(mm)					
		L	W	T	Thickness Code	Size Tol. Code	BW
03	0201	0.60±0.05	0.30±0.05	0.30±0.05	3	S	0.15±0.05
05	0402	1.00±0.07	0.50±0.07	0.50±0.07	5	S	0.25±0.10
		1.00±0.15	0.50±0.15	0.50±0.15	5	R	
		1.00±0.20	0.50±0.20	0.50±0.20	5	U	
		1.00±0.07	0.50±0.07	0.70±0.10	7	S	
		1.00±0.15	0.50±0.15	0.70±0.10	7	R	
10	0603	1.00±0.20	0.50±0.20	0.80±0.10	8	U	0.30±0.20
		1.60±0.10	0.80±0.10	0.80±0.10	8	N	
		1.60±0.20	0.80±0.20	0.80±0.20	8	R	
		1.60±0.25	0.80±0.25	0.80±0.25	8	U	
		1.60±0.10	0.80±0.10	0.90±0.10	9	H	
		1.60±0.20	0.80±0.20	0.85±0.10	C	R	
		1.60±0.25	0.80±0.25	0.85±0.10	C	U	
		1.60±0.10	0.80±0.10	0.95±0.10	N	H	
1.60±0.25	0.80±0.25	1.05±0.10	O	U			
21	0805	1.60±0.20	0.80±0.20	1.10±0.10	E	R	0.50 +0.20 / -0.30
		2.00±0.20	1.25±0.20	1.10±0.10	E	R	
		2.00±0.15	1.25±0.15	1.25±0.15	Q	N	

Low Acoustic Noise Capacitor

Low Acoustic Noise Capacitance Table (HMC* / X5R)

Size inch (mm)	Rated Voltage (Vdc)	Capacitance(μF)				
		2.2	4.7	10	22	47
0402 (1005)	6.3					
	10					
0603 (1608)	6.3					
	10					
0805 (2012)	6.3					
	25					

* HMC : Horizontally Mounted Capacitor

Low Acoustic Noise Capacitance Table (T – HMC* / X5R)

Size inch (mm)	T max. (mm)	Rated Voltage (Vdc)	Capacitance(μF)				
			2.2	4.7	10	22	47
0402 (1005)	0.8	6.3					
		10					
	0.9	6.3					
		10					
0603 (1608)	0.95	10					
	1.0	10					
	1.05	6.3					
		10					
	1.2	6.3					
	1.25	10					
0805 (2012)	1.2	25					
	1.7	25					

* T- HMC : Thick & Horizontally Mounted Capacitor

Product Line Up (HMC* / X5R)

Size L × W (mm / inch)	Thickness Max.	Rated Voltage	Capacitance	Capacitance Tolerance	Part Number	Remark
0.6 × 0.3 (0201)	0.35mm	10Vdc	1.0uF	±20%	CL03A105MP3NSNZ	Derating Ref.
1.0 × 0.5 (0402)	0.57mm	6.3Vdc	2.2uF	±20%	CL05A225MQ5NSNZ	Ref.
		10Vdc	2.2uF	±10%	CL05A225KP5NSNZ	Derating Ref.
	0.65mm	6.3Vdc	4.7uF	±20%	CL05A475MQ5NRNZ	Derating Ref.
		10Vdc	4.7uF	±10%	CL05A475KP5NRNZ	Derating Ref.
	0.70mm	6.3Vdc	10uF	±20%	CL05A106MQ5NUNZ	Derating Ref.
		10Vdc	10uF	±20%	CL05A106MP5NUNZ	Derating Ref.
		25Vdc	2.2uF	±20%	CL05A225MA5NUNZ	Derating Ref.
1.6 × 0.8 (0603)	0.90mm	6.3Vdc	2.2uF	±10%	CL10A225KQ8NNNZ	
			4.7uF	±10%	CL10A475KQ8NNNZ	
		10Vdc	2.2uF	±10%	CL10A225KP8NNNZ	
			4.7uF	±10%	CL10A475KP8NNNZ	
			10uF	±10%	CL10A106KP8NNNZ	Derating Ref.
	1.00mm	6.3Vdc	2.2uF	±20%	CL10A226MP8NNNR	Derating
			10uF	±20%	CL10A106MP8NNNR	Derating
	1.05mm	10Vdc	22uF	±20%	CL10A226MP8NUNR	Derating
2.0 × 1.25 (0805)	1.35mm	6.3Vdc	47uF	±20%	CL21A476MQMNRNR	Derating
			22uF	±20%	CL21A226MQMNNNR	
	1.40mm	6.3Vdc	22uF	±20%	CL21A226MQMNNNR	
		25Vdc	4.7uF	±10%	CL21A475KAQNNNR	Derating

* HMC : Horizontally Mounted Capacitor

Product Line Up (T - HMC* / X5R)

Size L × W (mm / inch)	Thickness Max. (mm)	Rated Voltage (Vdc)	Capacitance	Capacitance Tolerance	Part Number	Remark
1.0 × 0.5 (0402)	0.80mm	6.3Vdc	2.2uF	±10%	CL05A225KQ7NSB8	Ref.
			4.7uF	±20%	CL05A475MQ7NRB8	Derating Ref.
		10Vdc	2.2uF	±10%	CL05A225KP7NSB8	Derating Ref.
			4.7uF	±20%	CL05A475MP7NRB8	Derating Ref.
	0.90mm	6.3Vdc	10uF	±20%	CL05A106MQ8NUB8	Derating Ref.
		10Vdc	10uF	±20%	CL05A106MP8NUB8	Derating Ref.
1.6 × 0.8 (0603)	0.95mm	6.3Vdc	22uF	±20%	CL10A226MQCNRBE	Derating
		10Vdc	22uF	±20%	CL10A226MPCNUBE	Derating
	1.00mm	10Vdc	4.7uF	±10%	CL10A475KP9NHBC	
	1.05mm	6.3Vdc	10uF	±20%	CL10A106MQNNHBC	Ref.
		10Vdc	10uF	±20%	CL10A106MPNNHBC	Derating Ref.
	1.15mm	6.3Vdc	22uF	±20%	CL10A226MQONUBE	Derating
	1.20mm	6.3Vdc	47uF	±20%	CL10A476MQENRBE	Derating
	1.25mm	10Vdc	22uF	±20%	CL10A226MPMNUBE	Derating
		6.3Vdc	22uF	±20%	CL10A226MQMNUBE	Derating
2.0 × 1.25 (0805)	1.20mm	25Vdc	10uF	±10%	CL21A106KAENRBE	Derating

* T- HMC : Thick & Horizontally Mounted Capacitor

※ □ mark means packaging code. If you want to learn the code or quantity in detail, please see p.148
In order to move to the page directly, please click the here. ↑

High Effective Capacitance Capacitors

Feature

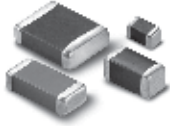

- Wide selection of size : from 0402(inch) to 1210(inch)
- When a DC bias is applied, a capacitance is higher than conventional products.
- Highly reliable performance
- Reduced capacitance degradation by bias and aging
- DC - bias performance (Graph) :

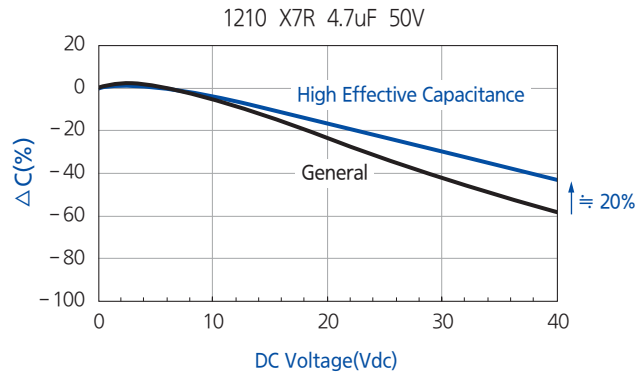

Application

- HDD / SSD board
- Display
- Digital Camera
- Lighting
- Mobile Phone
- PC (Laptop, Desktop)

Structure and Dimensions

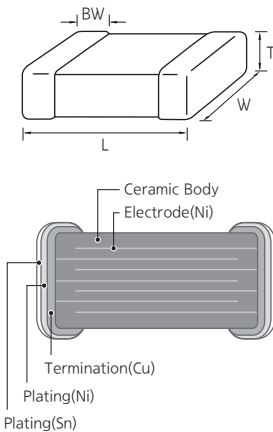

Size Code	EIA Code	Dimension(mm)				
		L	W	T	Thickness Code	BW
05	0402	1.00±0.05	0.50±0.05	0.50±0.05	5	0.25±0.10
10	0603	1.60±0.10	0.80±0.10	0.80±0.10	8	0.30±0.20
21	0805	2.00±0.20	1.25±0.20	0.85±0.10(*)	C	0.50+0.2/-0.30
		2.00±0.10	1.25±0.10	1.25±0.10	F	
		2.00±0.15	1.25±0.15	1.25±0.15	Q	
31	1206	3.20±0.20	1.60±0.20	0.85±0.10(*)	C	0.50±0.30
		3.20±0.20	1.60±0.20	1.60±0.20	H	
32	1210	3.20±0.30	2.50±0.20	1.80±0.20(*)	U	0.60±0.30
		3.20±0.30	2.50±0.20	2.50±0.20	J	

* Mark is only applicable to "L", "Y", "F", 12th code in part number.

High Effective Capacitance Table (X5R)

Size inch (mm)	Rated Voltage (Vdc)	Capacitance(nF)		Capacitance(uF)				
		680	820	1.0	2.2	4.7	10	22
0402 (1005)	6.3			█				
	16			█				
0603 (1608)	6.3			█	█		█	
	10	█		█	█		█	
	16			█	█		█	
	25			█				
0805 (2012)	4.0						█	
	6.3			█	█	█	█	
	10			█	█	█	█	
	16			█	█	█	█	
	25			█	█	█	█	
1206 (3216)	16						█	
	25					█	█	█

High Effective Capacitance Table (X6S)

Size inch (mm)	Rated Voltage (Vdc)	Capacitance(uF)				
		1.0	2.2	4.7	10	22
0402(1005)	10	█				
0603 (1608)	6.3			█		
	10			█		
	16		█	█		
	25		█	█		
1206 (3216)	10					█
	16				█	█
	25				█	█

High Effective Capacitance Table (X7R)

Size inch (mm)	Rated Voltage (Vdc)	Capacitance(uF)				
		1.0	2.2	4.7	10	22
0805 (2012)	10			█		
	25	█	█			
	50	█				
1206 (3216)	10				█	
	50			█		
1210 (3225)	25				█	
	50			█	█	

High Effective Capacitance Capacitors

Product Line Up (X5R)

■ Size : 1.60 X 0.80mm (inch : 0603)

Thickness Max.	Rated Voltage	Capacitance	Capacitance Tolerance	Part Number	Remark
0.90mm	6.3Vdc	1.0uF	±10%	CL10A105KQ8N3N□	
	10Vdc	680nF	±10%	CL10A684KP8N3N□	
		820nF	±10%	CL10A824KP8N3N□	
	16Vdc	1.0uF	±10%	CL10A105KQ8N3N□	
		2.2uF	±10%	CL10A225KQ8N3N□	

■ Size : 2.00 X 1.25mm (inch : 0805)

Thickness Max.	Rated Voltage	Capacitance	Capacitance Tolerance	Part Number	Remark
0.95mm	6.3Vdc	10uF	±10%	CL21A106KQCL3R□	
	10Vdc	10uF	±10%	CL21A106KPCL3R□	Derating
	16Vdc	10uF	±10%	CL21A106KOCL3R□	Derating
1.35mm	6.3Vdc	10uF	±10%	CL21A106KQFN3N□	
	10Vdc	10uF	±10%	CL21A106KPFN3N□	
	16Vdc	10uF	±10%	CL21A106KOFN3N□	Derating
	25Vdc	4.7uF	±10%	CL21A475KAFN3N□	Derating
10uF		±10%	CL21A106KAFN3N□	Derating	
1.40mm	4.0Vdc	10uF	±10%	CL21A106KRQN3N□	
	6.3Vdc	4.7uF	±10%	CL21A475KQQN3N□	Ref.
		10uF	±10%	CL21A106KQQN3N□	Ref.

■ Size : 3.20 X 1.60mm (inch : 1206)

Thickness Max.	Rated Voltage	Capacitance	Capacitance Tolerance	Part Number	Remark
0.95mm	16Vdc	10uF	±10%	CL31A106KOCL3N□	Derating
	25Vdc	4.7uF	±10%	CL31A475KAACL3N□	
		10uF	±10%	CL31A106KAACL3N□	Derating
1.80mm	25Vdc	22uF	±10%	CL31A226KAHN3N□	Derating

Product Line Up (X6S)

■ Size : 3.20 X 1.60mm (inch : 1206)

Thickness Max.	Rated Voltage	Capacitance	Capacitance Tolerance	Part Number	Remark
0.95mm	25Vdc	10uF	±10%	CL31X106KAACL3N□	Derating
1.80mm	10Vdc	22uF	±10%	CL31X226KPHN3N□	Derating
	16Vdc	22uF	±10%	CL31X226KOHN3N□	Derating
	25Vdc	22uF	±10%	CL31X226KAHN3N□	Derating

Product Line Up (X7R)

■ Size : 2.00 X 1.25mm (inch : 0805)

Thickness Max.	Rated Voltage	Capacitance	Capacitance Tolerance	Part Number	Remark
1.35mm	10Vdc	4.7uF	±10%	CL21B475KPFN3N□	Ref.
	25Vdc	1.0uF	±10%	CL21B105KAFN3N□	
		2.2uF	±10%	CL21B225KAFN3N□	
	50Vdc	1.0uF	±10%	CL21B105KBFN3N□	

■ Size : 3.20 X 1.60mm (inch : 1206)

Thickness Max.	Rated Voltage	Capacitance	Capacitance Tolerance	Part Number	Remark
1.80mm	10Vdc	10uF	±10%	CL31B106KPHN3N□	
	50Vdc	4.7uF	±10%	CL31B475KBHN3N□	

■ Size : 3.20 X 2.50mm (inch : 1210)

Thickness Max.	Rated Voltage	Capacitance	Capacitance Tolerance	Part Number	Remark
2.00mm	25Vdc	10uF	±10%	CL32B106KAUL3N□	
2.70mm	50Vdc	4.7uF	±10%	CL32B475KBJN3N□	

※ □ mark means packaging code. If you want to learn the code or quantity in detail, please see p.148
 In order to move to the page directly, please click the here. ↑

Feature



- Low ESL, good for noise reduction for high frequency
- Highly reliable performance
- Tape & reel for surface mount assembly

Application

- High Speed Microprocessor
- High Frequency Digital Equipment

Structure and Dimensions

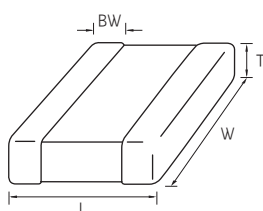

Size Code	EIA Code	Dimension(mm)				
		L	W	T	Thickness Code	BW
L5	0204	0.52±0.05	1.00±0.05	0.30±0.05	3	0.18±0.06
L6	0304	0.60±0.05	1.00±0.05	0.40±0.05	4	0.18±0.10
01	0306	0.80±0.05	1.60±0.20	0.50+0.05/-0.10	5	0.25±0.15

Low ESL Capacitance Table

Size inch (mm)	Rated Voltage (Vdc)	Capacitance(μF)						
		0.01	0.1	0.22	0.47	1.0	2.2	4.3
0204 (0510)	2.5					X7S		
	4.0				X6S			
	6.3		X7T					
0304(0610)	4.0						X5R	
0306 (0816)	4.0		X7S					
	6.3		X7R					
	10		X7R					
	25	X7R						

Product Line Up

EIA Code	Size L × W	Thickness Max.	Rated Voltage	TC Code	Capacitance	Capacitance Tolerance	Part Number	Remark
0204	0.50mm × 1.00mm	0.35mm	2.5Vdc	X7T	1.0μF	±20%	CLL5Z105MS3NLN□	Derating
			4.0Vdc	X6S	470nF	±20%	CLL5X474MR3NLN□	Derating
			6.3Vdc	X6S	1.0μF	±20%	CLL5X105MR3NLN□	Derating
			6.3Vdc	X7S	100nF	±20%	CLL5Y104MQ3NLN□	
0304	0.60mm × 1.00mm	0.45mm	4.0Vdc	X5R	4.3μF	±20%	CLL6A435MR4NLN□	Derating
0306	0.80mm × 1.60mm	0.55mm	4.0Vdc	X7S	100nF	±20%	CL01Y104MR5NLN□	
				X7S	1.0μF	±20%	CL01Y105MR5NLN□	Derating
			6.3Vdc	X7R	100nF	±10%	CL01B104KQ5NLN□	
			10Vdc	X7R	100nF	±10%	CL01B104KP5NLN□	
			25Vdc	X7R	10nF	±10%	CL01B103KA5NLN□	

※ □ mark means packaging code. If you want to learn the code or quantity in detail, please see p.148
 In order to move to the page directly, please click the here. †

Feature



- Low ESL, good for noise reduction for high frequency
- Highly reliable performance
- Tape & reel for surface mount assembly

Application

- High Speed Microprocessor
- High Frequency Digital Equipment

Structure and Dimensions

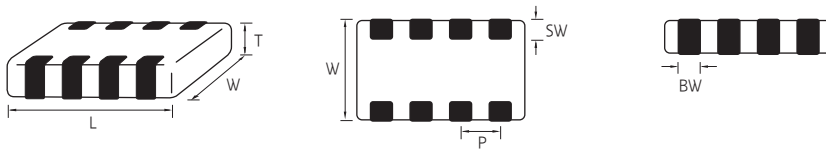

Size Code	EIA Code	Dimension(mm)						
		L	W	T	Thickness Code	BW	SW	P
10	0603	1.60±0.10	0.80±0.10	0.50+0.05/-0.10	5	0.25±0.10	0.15±0.10	0.40±0.10
21	0805	2.00±0.10	1.25±0.10	0.50+0.05/-0.10	5	0.25+0.15/-0.10	0.20+0.15/-0.10	0.50±0.10

Low ESL Capacitance Table

Size inch (mm)	T max. (mm)	Rated Voltage (Vdc)	Capacitance(μF)						
			0.1	0.22	0.47	0.68	1.0	2.2	4.3
0603(1608)	0.55	4.0		X7S				X7S	
0805(2012)	0.55	4.0			X7R				X7S

Product Line Up

EIA Code	Size L × W	Thickness Max.	Rated Voltage	TC Code	Capacitance	Capacitance Tolerance	Part Number
0603	1.60mm × 0.80mm	0.55mm	4.0Vdc	X7S	100nF	±20%	CL10Y104MR5NUN □
				X7S	470nF	±20%	CL10Y474MR5NUN □
				X7S	1.0μF	±20%	CL10Y105MR5NUN □
				X7S	2.2μF	±20%	CL10Y225MR5NUN □
0805	2.00mm × 1.25mm	0.55mm	4.0Vdc	X7S	2.2μF	±20%	CL21Y225MR5NUN □
			6.3Vdc	X7R	470nF	±20%	CL21B474MQ5NUN □
				X7R	680nF	±20%	CL21B684MQ5NUN □

※ □ mark means packaging code. If you want to learn the code or quantity in detail, please see p.148
 In order to move to the page directly, please click the here. †

Feature



- Low ESL, good for noise reduction for high frequency
- Highly reliable performance
- Tape & reel for surface mount assembly

Application

- High Speed Microprocessor
 - CPU / GPU for PC & Game console
 - AP for Smartphone
 - Network IC
- High Frequency Digital Equipment

Structure and Dimensions

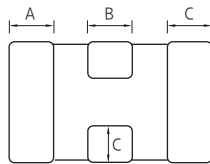
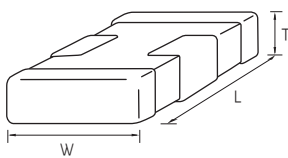

Size Code	EIA Code	Dimension(mm)						
		L	W	T	Thickness Code	BW		
						A	B	C
05	0402	1.05±0.05	0.65±0.05	0.45±0.05	5	0.17±0.10	0.35±0.10	0.15±0.10
19	0503	1.20±0.05	0.90±0.05	0.75±0.05	7	0.15±0.10	0.50±0.10	0.20±0.10

Low ESL Capacitance Table

Size inch (mm)	T max. (mm)	Rated Voltage (Vdc)	Capacitance(μF)					
			1.0	2.2	4.3	10	22	47
0402(1005)	0.5	4.0			X5R			
0503(1209)	0.8	4.0					X5R	

Product Line Up

EIA Code	Size L × W	Thickness Max.	Rated Voltage	TC Code	Capacitance	Capacitance Tolerance	Part Number
0402	1.00mm × 0.50mm	0.50mm	4.0Vdc	X5R	4.3μF	±20%	CL05A435MR5NWN□
0503	1.20mm × 0.90mm	0.80mm	4.0Vdc	X5R	22μF	±20%	CL19A226MR7NWN□

※ □ mark means packaging code. If you want to learn the code or quantity in detail, please see p.148
 In order to move to the page directly, please click the here. ↑

Feature

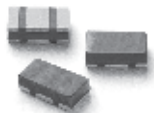

- Lowest ESL, good for noise reduction for high frequency
- Highly reliable performance
- Tape & reel for surface mount assembly

Application

- High Speed Microprocessor
 - CPU / GPU for PC & Game console
 - AP for Smartphone
 - Network IC
- High Frequency Digital Equipment

Structure and Dimensions

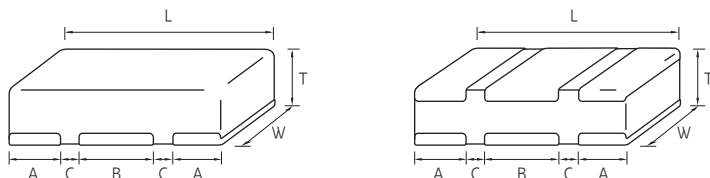

Size Code	EIA Code	Dimension(mm)						
		L	W	T	Thickness Code	Band Width		Band Gap
						A	B	C
21	0805	2.00±0.10	1.25±0.10	0.70±0.10 0.90±0.10	7 9	0.42±0.10	0.74±0.10	0.21±0.05

Low ESL Capacitance Table

Size inch (mm)	T max. (mm)	Rated Voltage (Vdc)	Capacitance(μF)							
			1.0	2.2	3.3	4.7	10	22	47	
0805(2012)	0.8	4.0								X5R
	1.0	4.0								X5R

Product Line Up

EIA Code	Size L × W	Thickness Max.	Rated Voltage	TC Code	Capacitance	Capacitance Tolerance	Part Number
0805	2.00mm × 1.25mm	0.80mm	4.0Vdc	X5R	47μF	±20%	CL21A476MR7NVN□
		1.00mm		X5R	47μF	±20%	CL21A476MR9NVN□

※ □ mark means packaging code. If you want to learn the code or quantity in detail, please see p.148
 In order to move to the page directly, please click the here. ↑

Low ESL Capacitors _ X2Y®

Feature



- One device for EMI suppression or decoupling
- Differential and common mode attenuation
- Matched capacitance line to ground, both lines

Application

- Amplifier Filter & Decoupling
- High Speed Data Filtering
- EMC I / O Filtering
- FPGA / ASIC / u - P Decoupling
- DDR Memory Decoupling

Structure and Dimensions

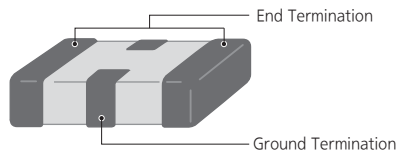
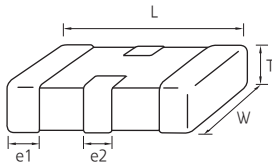

Size Code	EIA Code	Dimension(mm)					
		L	W	T	Thickness Code	e1	e2
10	0603	1.60±0.15	0.80±0.10	0.60±0.10	6	0.25±0.15	0.45±0.15

Low ESL Capacitance Table

Size inch (mm)	T max. (mm)	Rated Voltage (Vdc)	Capacitance						
			nF			uF			
			1.0	2.2	4.7	0.1	0.22	0.47	1.0
0603 (1608)	0.7	6.3					X7R		X5R
		10						X5R	
		16				X7R			
		25							
		50	X7R						
		100		X7R					

Product Line Up

EIA Code	Size L x W	Thickness Max.	Rated Voltage	TC Code	Capacitance	Capacitance Tolerance	Part Number
0603	1.60mm x 0.80mm	0.70mm	6.3Vdc	X7R	220nF	±20%	CL10B224MQ6NXX□
				X5R	1.0uF	±20%	CL10A105MQ6NXX□
			10Vdc	X5R	470nF	±20%	CL10A474MP6NXX□
				X5R	1.0uF	±20%	CL10A105MP6NXX□
			16Vdc	X7R	100nF	±20%	CL10B104M06NXX□
				X7R	220nF	±20%	CL10B224M06NXX□
			50Vdc	X7R	1.0nF	±20%	CL10B102MB6NXX□
			100Vdc	X7R	2.2nF	±20%	CL10B222MC6NXX□
				X7R	4.7nF	±20%	CL10B472MC6NXX□

※ □ mark means packaging code. If you want to learn the code or quantity in detail, please see p.148
 In order to move to the page directly, please click the here. ↑

Array Type Capacitors

Feature



- Reduction in required space (more than 50%)
- Reduction in cost and time for replacement of PCB
- Reduction in amount of solder joints
- Easier PCB design
- Reduced waste from tape and reel packaging process
- It protect EMI bypassing digital signal line nose

Application

- A bypass for digital and analog signal line noise generated by telecommunication equipment and other common electronic circuits

Structure and Dimensions

CL	14	A	105	M	A	5	N	A	N	C
1	2	3	4	5	6	7	8	9	10	11

■ A : ARRAY (2 – element)

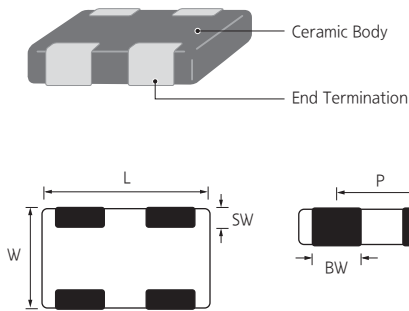

■ B : ARRAY (4 – element)

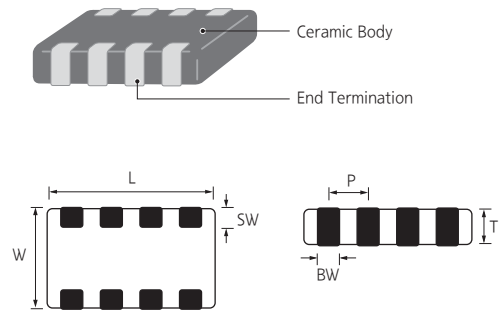

Code	Size (mm)	EIA Code	Dimension(mm)					
			L	W	T	BW	SW	P
A	0906	0302	0.90±0.05	0.60±0.05	0.45±0.05	0.25±0.05	0.15±0.10	0.45±0.05
A	1410	0504	1.37±0.15	1.00±0.15	0.35±0.05	0.36±0.10	0.20±0.10	0.64±0.10
					0.50±0.05			
					0.60±0.06			
					0.80±0.08			
A	2012	0805	2.00±0.15	1.25±0.15	0.85±0.10	0.50±0.20	0.25±0.15	1.00±0.10
B	2012	0805	2.00±0.15	1.25±0.15	0.85±0.10	0.25±0.10	0.25±0.15	0.50±0.10
B	3216	1206	3.20±0.15	1.60±0.15	0.85±0.15	0.40±0.20	0.30±0.15	0.80±0.20

Array Type capacitance Table (COG / X5R / X7R)

TC	Size inch (mm)	Type	Rated Voltage (Vdc)	T max. (mm)	Capacitance(pF)						
					10	22	27	47	100	470	
COG	0504(1410)	2 - element	25	0.88							
	1206(3216)	4 - element	50	1.00							

TC	Size inch (mm)	Type	Rated Voltage (Vdc)	T max. (mm)	Capacitance(nF)														
					1.0	2.2	4.7	10	22	47	100	220	470	1000	2200				
X5R	0302(0906)	2 - element	4.0	0.50															
			6.3																
			10																
	0504(1410)	2 - element	6.3	0.88															
				0.66															
				0.55															
				0.40															
			10	0.88															
				0.66															
				0.55															
				0.40															
			16	0.88															
				0.66															
				0.55															
				0.40															
	25	0.88																	
		0.66																	
		0.55																	
	0805(2012)	2 - element	6.3	0.95															
			10																
16																			
X7R	0805(2012)	4 - element	10	0.95															
			16																
	1206(3216)	4 - element	16	1.00															
			25																
			50																

Array Type Capacitors

Product Line Up (C0G / X5R)

■ Size : 0.90 X 0.60mm (inch : 0302)

Element Type	Thickness Max.	Rated Voltage	TC Code	Capacitance	Capacitance Tolerance	Part Number	Remark
2-Array	0.50mm	4.0Vdc	X5R	1.0uF	±20%	CL09A105MR4NAN□	Derating
		6.3Vdc	X5R	100nF	±10%	CL09A104KQ4SAN□	Derating
			X5R	1.0uF	±20%	CL09A105MQ4NAN□	Derating
		10Vdc	X5R	100nF	±10%	CL09A104KP4SAN□	

■ Size : 1.40 X 1.00mm (inch : 0504)

Element Type	Thickness Max.	Rated Voltage	TC Code	Capacitance	Capacitance Tolerance	Part Number	Remark
2-Array	0.66mm	25Vdc	C0G	27pF	±10%	CL14C270KA6NAN□	
	0.40mm	10Vdc	X5R	1.0uF	±20%	CL14A105MP3NAN□	Derating
		16Vdc	X5R	1.0uF	±20%	CL14A105MO3NAN□	Derating
	0.55mm	25Vdc	X5R	1.0uF	±20%	CL14A105MA5NAN□	Derating
	0.66mm	10Vdc	X5R	100nF	±10%	CL14A104KP6NAN□	
		25Vdc	X5R	100nF	±10%	CL14A104KA6NAN□	
	0.88mm	10Vdc	X5R	1.0uF	±10%	CL14A105KP8NAN□	Derating
			X5R	2.2uF	±10%	CL14A225KP8NAN□	Derating
		16Vdc	X5R	1.0uF	±20%	CL14A105MO8NAN□	Derating

Product Line Up (C0G / X5R / X7R)

■ Size : 2.00 X 1.25mm (inch : 0805)

Element Type	Thickness Max.	Rated Voltage	TC Code	Capacitance	Capacitance Tolerance	Part Number	Remark
2-Array	0.95mm	10Vdc	X5R	1.0uF	±20%	CL21A105MPCNAN□	
		16Vdc	X5R	1.0uF	±10%	CL21A105KOCNAN□	
4-Array	0.95mm	10Vdc	X7R	100nF	±20%	CL21B104MPCNBN□	
		16Vdc	X7R	100nF	±10%	CL21B104KOCNBN□	
		50Vdc	X7R	470pF	±10%	CL21B471KBCNBN□	

■ Size : 3.20 X 1.60mm (inch : 1206)

Element Type	Thickness Max.	Rated Voltage	TC Code	Capacitance	Capacitance Tolerance	Part Number	Remark	
4-Array	1.00mm	50Vdc	C0G	10pF	±5%	CL31C100JBCNBN□		
			C0G	15pF	±5%	CL31C150JBCNBN□		
			C0G	22pF	±5%	CL31C220JBCNBN□		
			C0G	27pF	±5%	CL31C270JBCNBN□		
			C0G	33pF	±10%	CL31C330KBCNBN□		
			C0G	39pF	±10%	CL31C390KBCNBN□		
			C0G	68pF	±5%	CL31C680JBCNBN□		
			C0G	82pF	±5%	CL31C820JBCNBN□		
			C0G	100pF	±5%	CL31C101JBCNBN□		
			C0G	150pF	±10%	CL31C151KBCNBN□		
			C0G	180pF	±5%	CL31C181JBCNBN□		
			C0G	330pF	±5%	CL31C331JBCNBN□		
			C0G	470pF	±5%	CL31C471JBCNBN□		
	1.00mm	16Vdc	X7R	100nF	±10%	CL31B104KOCNBN□		
			25Vdc	X7R	47nF	±10%	CL31B473KACNBN□	
				X7R	100nF	±10%	CL31B104KACNBN□	
		50Vdc	X7R	1.0nF	±20%	CL31B102MBCNBN□		
			X7R	10nF	±20%	CL31B103MBCNBN□		
			X7R	15nF	±10%	CL31B153KBCNBN□		

* □ mark means packaging code. If you want to learn the code or quantity in detail, please see p.148

In order to move to the page directly, please click the here. ↑

Industrial Capacitors Part Numbering System

CL	32	B	106	K	A	J	N	N	W	E
1	2	3	4	5	6	7	8	9	10	11

* SEMCO MLCC use 15 – digit Part Numbering system.

	8	9	10	Code	Meaning
Standard Termination	NNW				Industrial Capacitors (Networks, Power, etc)
	NFN				Industrial Capacitors for Power Application
	GQW / GNW				High Q Industrial Capacitors
	N3W				High Effective Capacitance Industrial Capacitors
Soft Termination	ZW6 / SW6				Soft – Termination(3mm) Industrial Capacitors
	ZNW / SNW				Soft – termination Industrial Capacitors
	ZFN / SFN / YFN				Soft – termination Capacitors for Power Application
Reinforced Soft Termination	Z46				Reinforced Soft – Termination(3mm) Industrial Capacitors
	Z4J				Reinforced Soft – Termination(5mm) Industrial Capacitors

* For the meaning of 8 (N, G, S, Z, and Y), please refer to the Page 05 (Part Numbering System).

Feature



- Rated voltage 6.3V~250V
- temperature range -55°C to +125°C (X7R/COG), -55°C to +85°C (X5R), case size 0201 to 2220
- Special outgoing inspection for industrial application (HALT, etc)

Application

- Network, Power application and etc.
- Ideal for decoupling and filtering applications (Class II : X5R/X7R/X6S)
- Impedance matching, tuning, coupling in high frequency circuit (Class I : COG)

Structure and Dimensions

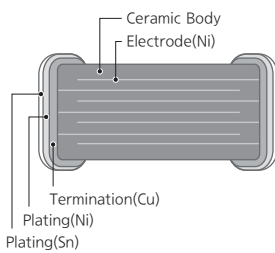
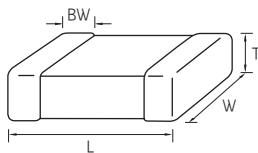

Size Code	EIA Code	Dimension(mm)				
		L	W	T	Thickness Code	BW
03	0201	0.60±0.03	0.30±0.03	0.30±0.03	3	0.15±0.05
05	0402	1.00±0.05	0.50±0.05	0.50±0.05	5	0.25±0.10
10	0603	1.60±0.10	0.80±0.10	0.80±0.10	8	0.30±0.20
21	0805	2.00±0.10	1.25±0.10	0.65±0.10	A	0.50+0.20/-0.30
				0.85±0.10	C	
				1.15±0.10	M	
				1.25±0.10	F	
31	1206	3.20±0.15	1.60±0.15	0.85±0.15	C	0.50±0.30
				1.25±0.15	F	
32	1210	3.20±0.30	2.50±0.20	1.60±0.20	H	0.60±0.30
				2.00±0.20	I	
				2.50±0.20	J	
				1.25±0.20	F	
42	1808	4.50±0.40	2.00±0.20	1.60±0.20	H	0.80±0.30
				2.00±0.20	I	
				1.25±0.20	F	
43	1812	4.50±0.40	3.20±0.30	1.60±0.20	H	0.80±0.30
				2.00±0.20	I	
				2.50±0.20	J	
55	2220	5.70±0.40	5.00±0.40	2.50±0.20	J	1.00±0.30

Industrial Capacitance Table (X5R)

Size inch (mm)	Rated Voltage (Vdc)	Capacitance																				
		pF				nF								uF								
		220	330	470	680	1.0	2.2	3.3	4.7	10	15	22	33	47	68	100	220	470	1.0	2.2	3.3	4.7
0201 (0603)	4.0																					
	6.3																					
	10																					

Size inch (mm)	Rated Voltage (Vdc)	Capacitance																				
		nF			uF																	
		100	220	470	1.0	2.2	4.7	10	22	47	100	220										
0402 (1005)	4.0																					
	6.3																					
	10																					
	16																					
0603 (1608)	4.0																					
	6.3																					
	10																					
	16																					
	25																					
0805 (2012)	4.0																					
	6.3																					
	10																					
	16																					
	25																					
1206 (3216)	6.3																					
	10																					
	16																					
	25																					
1210 (3225)	6.3																					
	10																					
	16																					
	25																					

Industrial Capacitance Table (X6S)

Size inch (mm)	Rated Voltage (Vdc)	Capacitance(uF)											
		0.1	0.22	0.47	1.0	2.2	4.7	10	22	47	100	220	
0402 (1005)	4.0												
	6.3												
	10												
0603 (1608)	4.0												
	6.3												
	10												
0805 (2012)	4.0												
	6.3												
1206(3216)	4.0												
1210 (3225)	6.3												
	10												
	16												

Industrial Capacitance Table (X7R / X7S)

Size inch (mm)	Rated Voltage (Vdc)	Capacitance															
		pF					nF										
		100	220	330	470	680	1.0	2.2	3.3	4.7	6.8	10	22	47	100		
0201 (0603)	10																
	16																
	25																

Size inch (mm)	Rated Voltage (Vdc)	Capacitance																							
		nF															uF								
		4.7	10	15	22	33	47	68	100	120	150	220	330	470	680	1.0	2.2	3.3	4.7	6.8	10	22	47	100	
0402 (1005)	6.3																								
	10																								
	16																								
	25																								
	50																								
0603 (1608)	6.3																								
	10																								
	16																								
	25																								
	50																								
100																									

Product Line Up (COG)

■ Size : 0.60 X 0.30mm (inch : 0201)

Thickness Max.	Rated Voltage	Capacitance	Capacitance Tolerance	Part Number
0.33mm	25Vdc	4.7pF	±0.25pF	CL03C4R7CA3GNW □
		10pF	±0.50pF	CL03C100DA3GNW □
		12pF	±5%	CL03C120JA3NNW □
		15pF	±5%	CL03C150JA3NNW □
		27pF	±5%	CL03C270JA3NNW □
		33pF	±5%	CL03C330JA3NNW □
		47pF	±5%	CL03C470JA3NNW □
		56pF	±5%	CL03C560JA3NNW □
		68pF	±5%	CL03C680JA3NNW □
		82pF	±5%	CL03C820JA3NNW □
100pF	±5%	CL03C101JA3NNW □		

■ Size : 1.00 X 0.50mm (inch : 0402)

Thickness Max.	Rated Voltage	Capacitance	Capacitance Tolerance	Part Number
0.55mm	25Vdc	82pF	±10%	CL05C820KA5NNW □
		150pF	±5%	CL05C151JA5NNW □
		220pF	±5%	CL05C221JA5NNW □
	50Vdc	0.1pF	±0.05pF	CL05C0R1AB5GNW □
		0.1pF	±0.1pF	CL05C0R1BB5GNW □
		0.2pF	±0.05pF	CL05C0R2AB5GNW □
		0.2pF	±0.1pF	CL05C0R2BB5GNW □
		0.3pF	±0.05pF	CL05C0R3AB5GNW □
		0.3pF	±0.1pF	CL05C0R3BB5GNW □
		0.4pF	±0.05pF	CL05C0R4AB5GNW □
		0.4pF	±0.1pF	CL05C0R4BB5GNW □
		0.5pF	±0.05pF	CL05C0R5AB5GNW □
		0.5pF	±0.1pF	CL05C0R5BB5GNW □
		0.6pF	±0.05pF	CL05C0R6AB5GNW □
		0.6pF	±0.1pF	CL05C0R6BB5GNW □
		0.7pF	±0.05pF	CL05C0R7AB5GNW □
		0.7pF	±0.1pF	CL05C0R7BB5GNW □
		0.8pF	±0.05pF	CL05C0R8AB5GNW □
		0.8pF	±0.1pF	CL05C0R8BB5GNW □
		0.9pF	±0.05pF	CL05C0R9AB5GNW □
		0.9pF	±0.1pF	CL05C0R9BB5GNW □
		1.0pF	±0.05pF	CL05C010AB5GNW □
		1.0pF	±0.1pF	CL05C010BB5GNW □
		1.0pF	±0.25pF	CL05C010CB5NNW □
		1.0pF	±0.25pF	CL05C010CB5GNW □
		1.1pF	±0.05pF	CL05C1R1AB5GNW □
1.1pF	±0.1pF	CL05C1R1BB5GNW □		
1.1pF	±0.25pF	CL05C1R1CB5GNW □		
1.2pF	±0.05pF	CL05C1R2AB5GNW □		
1.2pF	±0.1pF	CL05C1R2BB5GNW □		
1.2pF	±0.25pF	CL05C1R2CB5GNW □		
1.3pF	±0.05pF	CL05C1R3AB5GNW □		
1.3pF	±0.1pF	CL05C1R3BB5GNW □		
1.3pF	±0.25pF	CL05C1R3CB5GNW □		
1.5pF	±0.05pF	CL05C1R5AB5GNW □		
1.5pF	±0.1pF	CL05C1R5BB5GNW □		
1.5pF	±0.25pF	CL05C1R5CB5GNW □		
1.6pF	±0.05pF	CL05C1R6AB5GNW □		

Thickness Max.	Rated Voltage	Capacitance	Capacitance Tolerance	Part Number
0.55mm	50Vdc	1.6pF	±0.1pF	CL05C1R6BB5GNW □
		1.6pF	±0.25pF	CL05C1R6CB5GNW □
		1.8pF	±0.05pF	CL05C1R8AB5GNW □
		1.8pF	±0.1pF	CL05C1R8BB5NNW □
		1.8pF	±0.1pF	CL05C1R8BB5GNW □
		1.8pF	±0.25pF	CL05C1R8CB5GNW □
		2.0pF	±0.05pF	CL05C020AB5GNW □
		2.0pF	±0.1pF	CL05C020BB5GNW □
		2.0pF	±0.25pF	CL05C020CB5GNW □
		2.2pF	±0.05pF	CL05C2R2AB5GNW □
		2.2pF	±0.1pF	CL05C2R2BB5GNW □
		2.2pF	±0.25pF	CL05C2R2CB5NNW □
		2.2pF	±0.25pF	CL05C2R2CB5GNW □
		2.4pF	±0.05pF	CL05C2R4AB5GNW □
		2.4pF	±0.1pF	CL05C2R4BB5NNW □
		2.4pF	±0.1pF	CL05C2R4BB5GNW □
		2.4pF	±0.25pF	CL05C2R4CB5GNW □
		2.7pF	±0.05pF	CL05C2R7AB5GNW □
		2.7pF	±0.1pF	CL05C2R7BB5NNW □
		2.7pF	±0.1pF	CL05C2R7BB5GNW □
		2.7pF	±0.25pF	CL05C2R7CB5NNW □
		2.7pF	±0.25pF	CL05C2R7CB5GNW □
		3.0pF	±0.05pF	CL05C030AB5GNW □
		3.0pF	±0.1pF	CL05C030BB5GNW □
		3.0pF	±0.25pF	CL05C030CB5GNW □
		3.3pF	±0.05pF	CL05C3R3AB5GNW □
		3.3pF	±0.1pF	CL05C3R3BB5NNW □
		3.3pF	±0.1pF	CL05C3R3BB5GNW □
		3.3pF	±0.25pF	CL05C3R3CB5NNW □
		3.3pF	±0.25pF	CL05C3R3CB5GNW □
		3.6pF	±0.05pF	CL05C3R6AB5GNW □
		3.6pF	±0.1pF	CL05C3R6BB5NNW □
		3.6pF	±0.1pF	CL05C3R6BB5GNW □
		3.6pF	±0.25pF	CL05C3R6CB5GNW □
		3.9pF	±0.05pF	CL05C3R9AB5GNW □
		3.9pF	±0.1pF	CL05C3R9BB5GNW □
		3.9pF	±0.25pF	CL05C3R9CB5GNW □
		4.0pF	±0.05pF	CL05C040AB5GNW □
		4.0pF	±0.1pF	CL05C040BB5GNW □
		4.0pF	±0.25pF	CL05C040CB5GNW □
		4.3pF	±0.05pF	CL05C4R3AB5GNW □
		4.3pF	±0.1pF	CL05C4R3BB5GNW □
4.3pF	±0.25pF	CL05C4R3CB5GNW □		
4.7pF	±0.05pF	CL05C4R7AB5GNW □		
4.7pF	±0.1pF	CL05C4R7BB5GNW □		
4.7pF	±0.25pF	CL05C4R7CB5NNW □		
4.7pF	±0.25pF	CL05C4R7CB5GNW □		
5.0pF	±0.05pF	CL05C050AB5GNW □		
5.0pF	±0.1pF	CL05C050BB5GNW □		
5.0pF	±0.25pF	CL05C050CB5GNW □		
5.1pF	±0.05pF	CL05C5R1AB5GNW □		
5.1pF	±0.1pF	CL05C5R1BB5GNW □		
5.1pF	±0.25pF	CL05C5R1CB5GNW □		
5.1pF	±0.5pF	CL05C5R1DB5GNW □		

※ □ mark means packaging code. If you want to learn the code or quantity in detail, please see p.148

In order to move to the page directly, please click the here. ↑

Product Line Up (COG)

■ Size : 1.00 X 0.50mm (inch : 0402)

Thickness Max.	Rated Voltage	Capacitance	Capacitance Tolerance	Part Number	Thickness Max.	Rated Voltage	Capacitance	Capacitance Tolerance	Part Number
0.55mm	50Vdc	5.6pF	±0.05pF	CL05C5R6AB5GNW□	0.55mm	50Vdc	12pF	±5%	CL05C120JB5NNW□
		5.6pF	±0.1pF	CL05C5R6BB5GNW□			12pF	±5%	CL05C120JB5GNW□
		5.6pF	±0.25pF	CL05C5R6CB5NNW□			15pF	±1%	CL05C150FB5GNW□
		5.6pF	±0.25pF	CL05C5R6CB5GNW□			15pF	±2%	CL05C150GB5GNW□
		5.6pF	±0.5pF	CL05C5R6DB5GNW□			15pF	±5%	CL05C150JB5GNW□
		6.0pF	±0.05pF	CL05C060AB5GNW□			18pF	±1%	CL05C180FB5GNW□
		6.0pF	±0.1pF	CL05C060BB5GNW□			18pF	±2%	CL05C180GB5GNW□
		6.0pF	±0.25pF	CL05C060CB5GNW□			18pF	±5%	CL05C180JB5NNW□
		6.0pF	±0.5pF	CL05C060DB5GNW□			18pF	±5%	CL05C180JB5GNW□
		6.2pF	±0.05pF	CL05C6R2AB5GNW□			20pF	±1%	CL05C200FB5GNW□
		6.2pF	±0.1pF	CL05C6R2BB5GNW□			20pF	±2%	CL05C200GB5GNW□
		6.2pF	±0.25pF	CL05C6R2CB5GNW□			20pF	±5%	CL05C200JB5GNW□
		6.2pF	±0.5pF	CL05C6R2DB5GNW□			22pF	±1%	CL05C220FB5GNW□
		6.8pF	±0.05pF	CL05C6R8AB5GNW□			22pF	±2%	CL05C220GB5GNW□
		6.8pF	±0.1pF	CL05C6R8BB5NNW□			22pF	±5%	CL05C220JB5NNW□
		6.8pF	±0.1pF	CL05C6R8BB5GNW□			22pF	±5%	CL05C220JB5GNW□
		6.8pF	±0.25pF	CL05C6R8CB5NNW□			24pF	±1%	CL05C240FB5GNW□
		6.8pF	±0.25pF	CL05C6R8CB5GNW□			24pF	±2%	CL05C240GB5GNW□
		6.8pF	±0.5pF	CL05C6R8DB5GNW□			24pF	±5%	CL05C240JB5NNW□
		7.0pF	±0.05pF	CL05C070AB5GNW□			24pF	±5%	CL05C240JB5GNW□
		7.0pF	±0.1pF	CL05C070BB5GNW□			27pF	±1%	CL05C270FB5GNW□
		7.0pF	±0.25pF	CL05C070CB5GNW□			27pF	±2%	CL05C270GB5GNW□
		7.0pF	±0.5pF	CL05C070DB5GNW□			27pF	±5%	CL05C270JB5NNW□
		7.5pF	±0.05pF	CL05C7R5AB5GNW□			27pF	±5%	CL05C270JB5GNW□
		7.5pF	±0.1pF	CL05C7R5BB5GNW□			33pF	±1%	CL05C330FB5GNW□
		7.5pF	±0.25pF	CL05C7R5CB5GNW□			33pF	±2%	CL05C330GB5GNW□
		7.5pF	±0.5pF	CL05C7R5DB5GNW□			33pF	±5%	CL05C330JB5NNW□
		8.0pF	±0.05pF	CL05C080AB5GNW□			33pF	±5%	CL05C330JB5GNW□
		8.0pF	±0.1pF	CL05C080BB5GNW□			39pF	±1%	CL05C390FB5GNW□
		8.0pF	±0.25pF	CL05C080CB5GNW□			39pF	±2%	CL05C390GB5GNW□
		8.0pF	±0.5pF	CL05C080DB5GNW□			39pF	±5%	CL05C390JB5NNW□
		8.2pF	±0.05pF	CL05C8R2AB5GNW□			39pF	±5%	CL05C390JB5GNW□
		8.2pF	±0.1pF	CL05C8R2BB5NNW□			47pF	±1%	CL05C470FB5GNW□
		8.2pF	±0.1pF	CL05C8R2BB5GNW□			47pF	±2%	CL05C470GB5GNW□
		8.2pF	±0.25pF	CL05C8R2CB5GNW□			47pF	±5%	CL05C470JB5NNW□
		8.2pF	±0.5pF	CL05C8R2DB5GNW□			47pF	±5%	CL05C470JB5GNW□
		9.0pF	±0.05pF	CL05C090AB5GNW□			51pF	±5%	CL05C510JB5NNW□
		9.0pF	±0.1pF	CL05C090BB5GNW□			56pF	±5%	CL05C560JB5NNW□
		9.0pF	±0.25pF	CL05C090CB5GNW□			68pF	±5%	CL05C680JB5NNW□
		9.0pF	±0.5pF	CL05C090DB5GNW□			82pF	±5%	CL05C820JB5NNW□
9.1pF	±0.05pF	CL05C9R1AB5GNW□	82pF	±10%	CL05C820KB5NNW□				
9.1pF	±0.1pF	CL05C9R1BB5GNW□	100pF	±5%	CL05C101JB5NNW□				
9.1pF	±0.25pF	CL05C9R1CB5GNW□	120pF	±5%	CL05C121JB5NNW□				
9.1pF	±0.5pF	CL05C9R1DB5GNW□	150pF	±5%	CL05C151JB5NNW□				
10pF	±1%	CL05C100FB5GNW□	180pF	±5%	CL05C181JB5NNW□				
10pF	±2%	CL05C100GB5GNW□	270pF	±1%	CL05C271FB5NNW□				
10pF	±5%	CL05C100JB5NNW□	270pF	±5%	CL05C271JB5NNW□				
10pF	±5%	CL05C100JB5GNW□	330pF	±5%	CL05C331JB5NNW□				
11pF	±1%	CL05C110FB5GNW□	390pF	±1%	CL05C391FB5NNW□				
11pF	±2%	CL05C110GB5GNW□	390pF	±5%	CL05C391JB5NNW□				
11pF	±5%	CL05C110JB5GNW□	470pF	±1%	CL05C471FB5NNW□				
12pF	±1%	CL05C120FB5GNW□	470pF	±5%	CL05C471JB5NNW□				
12pF	±2%	CL05C120GB5NNW□	560pF	±5%	CL05C561JB5NNW□				
12pF	±2%	CL05C120GB5GNW□	680pF	±5%	CL05C681JB5NNW□				

※ □ mark means packaging code. If you want to learn the code or quantity in detail, please see p.148
In order to move to the page directly, please click the here. ↑

Product Line Up (COG)

■ Size : 1.00 X 0.50mm (inch : 0402)

Thickness Max.	Rated Voltage	Capacitance	Capacitance Tolerance	Part Number
0.55mm	50Vdc	820pF	±5%	CL05C821JB5NNW□
		1.0nF	±5%	CL05C102JB5NNW□
	100Vdc	47pF	±5%	CL05C470JC5NNW□

■ Size : 1.60 X 0.80mm (inch : 0603)

Thickness Max.	Rated Voltage	Capacitance	Capacitance Tolerance	Part Number
0.90mm	50Vdc	1.0pF	±0.25pF	CL10C010CB8NNW□
		1.2pF	±0.25pF	CL10C1R2CB8NNW□
		1.5pF	±0.1pF	CL10C1R5BB8NNW□
		1.5pF	±0.25pF	CL10C1R5CB8NNW□
		2.2pF	±0.1pF	CL10C2R2BB8NNW□
		2.2pF	±0.25pF	CL10C2R2CB8NNW□
		2.7pF	±0.1pF	CL10C2R7BB8NNW□
		2.7pF	±0.25pF	CL10C2R7CB8NNW□
		3.3pF	±0.1pF	CL10C3R3BB8NNW□
		3.3pF	±0.25pF	CL10C3R3CB8NNW□
		3.3pF	±0.5pF	CL10C3R3DB8NNW□
		3.6pF	±0.25pF	CL10C3R6CB8NNW□
		3.9pF	±0.1pF	CL10C3R9BB8NNW□
		3.9pF	±0.25pF	CL10C3R9CB8NNW□
		4.7pF	±0.1pF	CL10C4R7BB8NNW□
		4.7pF	±0.25pF	CL10C4R7CB8NNW□
		4.7pF	±0.5pF	CL10C4R7DB8NNW□
		5.0pF	±0.1pF	CL10C050BB8NNW□
		5.6pF	±0.25pF	CL10C5R6CB8NNW□
		6.2pF	±0.25pF	CL10C6R2CB8NNW□
		6.8pF	±0.25pF	CL10C6R8CB8NNW□
		6.8pF	±0.5pF	CL10C6R8DB8NNW□
		8.2pF	±0.25pF	CL10C8R2CB8NNW□
		9.0pF	±5%	CL10C090JB8NNW□
		10pF	±0.25pF	CL10C100CB8NNW□
		10pF	±5%	CL10C100JB8NNW□
		15pF	±1%	CL10C150FB8NNW□
		15pF	±5%	CL10C150JB8NNW□
		20pF	±5%	CL10C200JB8NNW□
		22pF	±1%	CL10C220FB8NNW□
		22pF	±2%	CL10C220GB8NNW□
		22pF	±5%	CL10C220JB8NNW□
		27pF	±5%	CL10C270JB8NNW□
		30pF	±5%	CL10C300JB8NNW□
		33pF	±5%	CL10C330JB8NNW□
		33pF	±10%	CL10C330KB8NNW□
		47pF	±5%	CL10C470JB8NNW□
		47pF	±10%	CL10C470KB8NNW□
		56pF	±5%	CL10C560JB8NNW□
		68pF	±5%	CL10C680JB8NNW□
		82pF	±1%	CL10C820FB8NNW□
		82pF	±5%	CL10C820JB8NNW□
100pF	±1%	CL10C101FB8NNW□		
100pF	±5%	CL10C101JB8NNW□		
100pF	±10%	CL10C101KB8NNW□		
120pF	±5%	CL10C121JB8NNW□		

Thickness Max.	Rated Voltage	Capacitance	Capacitance Tolerance	Part Number
0.90mm	50Vdc	150pF	±1%	CL10C151FB8NNW□
		150pF	±2%	CL10C151GB8NNW□
		150pF	±5%	CL10C151JB8NNW□
		180pF	±5%	CL10C181JB8NNW□
		220pF	±2%	CL10C221GB8NNW□
		220pF	±5%	CL10C221JB8NNW□
		270pF	±1%	CL10C271FB8NNW□
		270pF	±5%	CL10C271JB8NNW□
		330pF	±5%	CL10C331JB8NNW□
		390pF	±5%	CL10C391JB8NNW□
		390pF	±10%	CL10C391KB8NNW□
		470pF	±5%	CL10C471JB8NNW□
		680pF	±5%	CL10C681JB8NNW□
		820pF	±10%	CL10C821KB8NNW□
		1.0nF	±5%	CL10C102JB8NNW□
		1.2nF	±5%	CL10C122JB8NNW□
		1.5nF	±5%	CL10C152JB8NNW□
		100Vdc	10pF	±5%
	33pF		±5%	CL10C330JC8NNW□
	47pF		±5%	CL10C470JC8NNW□
	82pF		±5%	CL10C820JC8NNW□
	100pF		±5%	CL10C101JC8NNW□
	150pF		±5%	CL10C151JC8NNW□
	220pF		±5%	CL10C221JC8NNW□
	270pF		±5%	CL10C271JC8NNW□
	330pF		±5%	CL10C331JC8NNW□

■ Size : 2.00 X 1.25mm (inch : 0805)

Thickness Max.	Rated Voltage	Capacitance	Capacitance Tolerance	Part Number		
0.75mm	50Vdc	1.0pF	±0.25pF	CL21C010CBANNW□		
		1.5pF	±0.1pF	CL21C1R5BBANNW□		
		10pF	±0.5pF	CL21C100DBANNW□		
		10pF	±5%	CL21C100JBANNW□		
		15pF	±5%	CL21C150JBANNW□		
		22pF	±1%	CL21C220FBANNW□		
		22pF	±5%	CL21C220JBANNW□		
		33pF	±5%	CL21C330JBANNW□		
		47pF	±5%	CL21C470JBANNW□		
		47pF	±10%	CL21C470KBANNW□		
		100pF	±2%	CL21C101GBANNW□		
		100pF	±5%	CL21C101JBANNW□		
		120pF	±5%	CL21C121JBANNW□		
		150pF	±5%	CL21C151JBANNW□		
		220pF	±5%	CL21C221JBANNW□		
		220pF	±10%	CL21C221KBANNW□		
		330pF	±1%	CL21C331FBANNW□		
		1.0nF	±5%	CL21C102JBANNW□		
	100Vdc	15pF	±5%	CL21C150JCANNW□		
		100pF	±5%	CL21C101JCANNW□		
		150pF	±5%	CL21C151JCANNW□		
		0.95mm	50Vdc	680pF	±5%	CL21C681JBCNNW□
				1.0nF	±5%	CL21C102JBCNNW□

※ □ mark means packaging code. If you want to learn the code or quantity in detail, please see p.148
 In order to move to the page directly, please click the here. ↑

Product Line Up (COG)

■ Size : 2.00 X 1.25mm (inch : 0805)

Thickness Max.	Rated Voltage	Capacitance	Capacitance Tolerance	Part Number	Thickness Max.	Rated Voltage	Capacitance	Capacitance Tolerance	Part Number
0.95mm	100Vdc	470pF	±5%	CL21C471JCCNNW□	0.95mm	250Vdc	3.3pF	±0.05pF	CL21C3R3AECGNW□
		680pF	±5%	CL21C681JCCNNW□			3.3pF	±0.1pF	CL21C3R3BECGNW□
	200Vdc	220pF	±5%	CL21C221JDCNNW□			3.3pF	±0.25pF	CL21C3R3CECGNW□
		250Vdc	0.5pF	±0.05pF			CL21C0R5AECGNW□	3.6pF	±0.05pF
	0.5pF		±0.1pF	CL21C0R5BECGNW□			3.6pF	±0.1pF	CL21C3R6BECGNW□
	0.5pF		±0.25pF	CL21C0R5CECGNW□			3.6pF	±0.25pF	CL21C3R6CECGNW□
	0.6pF		±0.05pF	CL21C0R6AECGNW□			3.9pF	±0.05pF	CL21C3R9AECGNW□
	0.6pF		±0.1pF	CL21C0R6BECGNW□			3.9pF	±0.1pF	CL21C3R9BECGNW□
	0.6pF		±0.25pF	CL21C0R6CECGNW□			3.9pF	±0.25pF	CL21C3R9CECGNW□
	0.7pF		±0.05pF	CL21C0R7AECGNW□			4.0pF	±0.05pF	CL21C040AECGNW□
	0.7pF		±0.1pF	CL21C0R7BECGNW□			4.0pF	±0.1pF	CL21C040BECGNW□
	0.7pF		±0.25pF	CL21C0R7CECGNW□			4.0pF	±0.25pF	CL21C040CECGNW□
	0.8pF		±0.05pF	CL21C0R8AECGNW□			4.3pF	±0.05pF	CL21C4R3AECGNW□
	0.8pF		±0.1pF	CL21C0R8BECGNW□			4.3pF	±0.1pF	CL21C4R3BECGNW□
	0.8pF		±0.25pF	CL21C0R8CECGNW□			4.3pF	±0.25pF	CL21C4R3CECGNW□
	0.9pF		±0.05pF	CL21C0R9AECGNW□			4.7pF	±0.05pF	CL21C4R7AECGNW□
	0.9pF		±0.1pF	CL21C0R9BECGNW□			4.7pF	±0.1pF	CL21C4R7BECGNW□
	0.9pF		±0.25pF	CL21C0R9CECGNW□			4.7pF	±0.25pF	CL21C4R7CECGNW□
	1.0pF		±0.05pF	CL21C010AECGNW□			5.0pF	±0.05pF	CL21C050AECGNW□
	1.0pF		±0.1pF	CL21C010BECGNW□			5.0pF	±0.1pF	CL21C050BECGNW□
	1.0pF		±0.25pF	CL21C010CECGNW□			5.0pF	±0.25pF	CL21C050CECGNW□
	1.1pF		±0.05pF	CL21C1R1AECGNW□			5.1pF	±0.05pF	CL21C5R1AECGNW□
	1.1pF		±0.1pF	CL21C1R1BECGNW□			5.1pF	±0.1pF	CL21C5R1BECGNW□
	1.1pF		±0.25pF	CL21C1R1CECGNW□			5.1pF	±0.25pF	CL21C5R1CECGNW□
	1.2pF		±0.05pF	CL21C1R2AECGNW□			5.1pF	±0.5pF	CL21C5R1DECGNW□
	1.2pF		±0.1pF	CL21C1R2BECGNW□			5.6pF	±0.05pF	CL21C5R6AECGNW□
	1.2pF		±0.25pF	CL21C1R2CECGNW□			5.6pF	±0.1pF	CL21C5R6BECGNW□
	1.3pF		±0.05pF	CL21C1R3AECGNW□			5.6pF	±0.25pF	CL21C5R6CECGNW□
	1.3pF		±0.1pF	CL21C1R3BECGNW□			5.6pF	±0.5pF	CL21C5R6DECGNW□
	1.3pF		±0.25pF	CL21C1R3CECGNW□			6.0pF	±0.05pF	CL21C060AECGNW□
	1.5pF		±0.05pF	CL21C1R5AECGNW□			6.0pF	±0.1pF	CL21C060BECGNW□
	1.5pF		±0.1pF	CL21C1R5BECGNW□			6.0pF	±0.25pF	CL21C060CECGNW□
	1.5pF		±0.25pF	CL21C1R5CECGNW□			6.0pF	±0.5pF	CL21C060DECGNW□
	1.6pF		±0.05pF	CL21C1R6AECGNW□			6.2pF	±0.05pF	CL21C6R2AECGNW□
	1.6pF		±0.1pF	CL21C1R6BECGNW□			6.2pF	±0.1pF	CL21C6R2BECGNW□
	1.6pF		±0.25pF	CL21C1R6CECGNW□			6.2pF	±0.25pF	CL21C6R2CECGNW□
	1.8pF		±0.05pF	CL21C1R8AECGNW□			6.2pF	±0.5pF	CL21C6R2DECGNW□
	1.8pF		±0.1pF	CL21C1R8BECGNW□			6.8pF	±0.05pF	CL21C6R8AECGNW□
	1.8pF		±0.25pF	CL21C1R8CECGNW□			6.8pF	±0.1pF	CL21C6R8BECGNW□
	2.0pF		±0.05pF	CL21C020AECGNW□			6.8pF	±0.25pF	CL21C6R8CECGNW□
	2.0pF		±0.1pF	CL21C020BECGNW□			6.8pF	±0.5pF	CL21C6R8DECGNW□
	2.0pF	±0.25pF	CL21C020CECGNW□	7.0pF			±0.05pF	CL21C070AECGNW□	
2.2pF	±0.05pF	CL21C2R2AECGNW□	7.0pF	±0.1pF	CL21C070BECGNW□				
2.2pF	±0.1pF	CL21C2R2BECGNW□	7.0pF	±0.25pF	CL21C070CECGNW□				
2.2pF	±0.25pF	CL21C2R2CECGNW□	7.0pF	±0.5pF	CL21C070DECGNW□				
2.4pF	±0.05pF	CL21C2R4AECGNW□	7.5pF	±0.05pF	CL21C7R5AECGNW□				
2.4pF	±0.1pF	CL21C2R4BECGNW□	7.5pF	±0.1pF	CL21C7R5BECGNW□				
2.4pF	±0.25pF	CL21C2R4CECGNW□	7.5pF	±0.25pF	CL21C7R5CECGNW□				
2.7pF	±0.05pF	CL21C2R7AECGNW□	7.5pF	±0.5pF	CL21C7R5DECGNW□				
2.7pF	±0.1pF	CL21C2R7BECGNW□	8.0pF	±0.05pF	CL21C080AECGNW□				
2.7pF	±0.25pF	CL21C2R7CECGNW□	8.0pF	±0.1pF	CL21C080BECGNW□				
3.0pF	±0.05pF	CL21C030AECGNW□	8.0pF	±0.25pF	CL21C080CECGNW□				
3.0pF	±0.1pF	CL21C030BECGNW□	8.0pF	±0.5pF	CL21C080DECGNW□				
3.0pF	±0.25pF	CL21C030CECGNW□	8.2pF	±0.05pF	CL21C8R2AECGNW□				

※ □ mark means packaging code. If you want to learn the code or quantity in detail, please see p.148
In order to move to the page directly, please click the here. ↑

Product Line Up (COG)

■ Size : 2.00 X 1.25mm (inch : 0805)

Thickness Max.	Rated Voltage	Capacitance	Capacitance Tolerance	Part Number	Thickness Max.	Rated Voltage	Capacitance	Capacitance Tolerance	Part Number			
0.95mm	250Vdc	8.2pF	±0.1pF	CL21C8R2BECGNW□	0.95mm	250Vdc	68pF	±5%	CL21C680JECGNW□			
		8.2pF	±0.25pF	CL21C8R2CECGNW□			82pF	±1%	CL21C820FECGNW□			
		8.2pF	±0.5pF	CL21C8R2DECGNW□			82pF	±2%	CL21C820GECGNW□			
		9.0pF	±0.05pF	CL21C090AECGNW□			82pF	±5%	CL21C820JECGNW□			
		9.0pF	±0.1pF	CL21C090BECGNW□			100pF	±1%	CL21C101FECGNW□			
		9.0pF	±0.25pF	CL21C090CECGNW□			100pF	±2%	CL21C101GECGNW□			
		9.0pF	±0.5pF	CL21C090DECGNW□			100pF	±5%	CL21C101JECGNW□			
		9.1pF	±0.05pF	CL21C9R1AECGNW□			100pF	±5%	CL21C101JECNNW□			
		9.1pF	±0.1pF	CL21C9R1BECGNW□			1.35mm	25Vdc	3.3nF	±1%	CL21C332FAFNW□	
		9.1pF	±0.25pF	CL21C9R1CECGNW□					50Vdc	1.2nF	±5%	CL21C122JBFNWW□
		9.1pF	±0.5pF	CL21C9R1DECGNW□						1.2nF	±5%	CL21C122JBFNWW□
		10pF	±1%	CL21C100FECGNW□						1.5nF	±5%	CL21C152JBFNWW□
		10pF	±2%	CL21C100GECGNW□						2.2nF	±5%	CL21C222JBFNWW□
		10pF	±5%	CL21C100JECGNW□						2.7nF	±5%	CL21C272JBFNWW□
		10pF	±5%	CL21C100JECNNW□						2.7nF	±5%	CL21C272JBFNWW□
		11pF	±1%	CL21C110FECGNW□	3.3nF	±5%				CL21C332JBFNWW□		
		11pF	±2%	CL21C110GECGNW□	3.3nF	±5%				CL21C332JBFNWW□		
		11pF	±5%	CL21C110JECGNW□	3.9nF	±5%				CL21C392JBFNWW□		
		12pF	±1%	CL21C120FECGNW□	4.7nF	±5%				CL21C472JBFNWW□		
		12pF	±2%	CL21C120GECGNW□	4.7nF	±5%			CL21C472JBFNWW□			
		12pF	±5%	CL21C120JECGNW□	100Vdc	1.0nF			±5%	CL21C102JCFNWW□		
		15pF	±1%	CL21C150FECGNW□		200Vdc			470pF	±5%	CL21C471JDFNWW□	
		15pF	±2%	CL21C150GECGNW□					630Vdc	39pF	±5%	CL21C390JHFNWW□
		15pF	±5%	CL21C150JECGNW□								
		18pF	±1%	CL21C180FECGNW□								
		18pF	±2%	CL21C180GECGNW□								
		18pF	±5%	CL21C180JECGNW□								
		20pF	±1%	CL21C200FECGNW□								
		20pF	±2%	CL21C200GECGNW□								
		20pF	±5%	CL21C200JECGNW□								
		22pF	±1%	CL21C220FECGNW□								
		22pF	±2%	CL21C220GECGNW□								
		22pF	±5%	CL21C220JECGNW□								
24pF	±1%	CL21C240FECGNW□										
24pF	±2%	CL21C240GECGNW□										
24pF	±5%	CL21C240JECGNW□										
27pF	±1%	CL21C270FECGNW□										
27pF	±2%	CL21C270GECGNW□										
27pF	±5%	CL21C270JECGNW□										
33pF	±1%	CL21C330FECGNW□										
33pF	±2%	CL21C330GECGNW□										
33pF	±5%	CL21C330JECGNW□										
33pF	±5%	CL21C330JECNNW□										
39pF	±1%	CL21C390FECGNW□										
39pF	±2%	CL21C390GECGNW□										
39pF	±5%	CL21C390JECGNW□										
47pF	±1%	CL21C470FECGNW□										
47pF	±2%	CL21C470GECGNW□										
47pF	±5%	CL21C470JECGNW□										
62pF	±1%	CL21C620FECGNW□										
62pF	±2%	CL21C620GECGNW□										
62pF	±5%	CL21C620JECGNW□										
68pF	±1%	CL21C680FECGNW□										
68pF	±2%	CL21C680GECGNW□										

※ □ mark means packaging code. If you want to learn the code or quantity in detail, please see p.148
 In order to move to the page directly, please click the here. ↑

Product Line Up (COG)

■ Size : 3.20 X 1.60mm (inch : 1206)

Thickness Max.	Rated Voltage	Capacitance	Capacitance Tolerance	Part Number
1.00mm	50Vdc	1.0nF	±5%	CL31C102JBCNNW□
		1.5nF	±2%	CL31C152GBCNNW□
	100Vdc	100pF	±5%	CL31C101JCCNNW□
		220pF	±5%	CL31C221JCCNNW□
		560pF	±5%	CL31C561JCCNNW□
		680pF	±5%	CL31C681JCCNNW□
		2.2nF	±5%	CL31C222JCCNNW□
1.40mm	25Vdc	10nF	±1%	CL31C103JAFNNW□
		10nF	±2%	CL31C103GAFNNW□
	50Vdc	3.3nF	±5%	CL31C332JBFNNW□
	200Vdc	1.0nF	±5%	CL31C102JDFNNW□
	500Vdc	10pF	±5%	CL31C100JGFNNW□
		39pF	±5%	CL31C390JGFNNW□
		220pF	±5%	CL31C221JGFNNW□
		330pF	±5%	CL31C331JGFNNW□
		470pF	±5%	CL31C471JGFNNW□
	630Vdc	220pF	±5%	CL31C221JHFNNW□
1.80mm	25Vdc	47nF	±5%	CL31C473JAHNNW□
		100nF	±5%	CL31C104JAHNNW□
	50Vdc	5.6nF	±5%	CL31C562JBHNNW□
		6.8nF	±5%	CL31C682JBHNNW□
		12nF	±5%	CL31C123JBHNNW□
		22nF	±5%	CL31C223JBHNNW□
		27nF	±5%	CL31C273JBHNNW□
		33nF	±5%	CL31C333JBHNNW□
	2kVdc	22pF	±10%	CL31C220KJHNNW□

■ Size : 3.20 X 2.50mm (inch : 1210)

Thickness Max.	Rated Voltage	Capacitance	Capacitance Tolerance	Part Number
1.45mm	1kVdc	100pF	±10%	CL32C101KIFNNW□
2.70mm	100Vdc	47nF	±5%	CL32C473JCJNNW□

※ □ mark means packaging code. If you want to learn the code or quantity in detail, please see p.148
In order to move to the page directly, please click the here. †

Product Line Up (X5R)

■ Size : 0.60 X 0.30mm (inch : 0201)

Thickness Max.	Rated Voltage	Capacitance	Capacitance Tolerance	Part Number	Remark	
0.33mm	6.3Vdc	10nF	±10%	CL03A103KQ3NNW□		
		100nF	±10%	CL03A104KQ3NNW□	Derating	
		220nF	±10%	CL03A224KQ3NNW□	Derating Ref	
		220nF	±20%	CL03A224MQ3NNW□	Derating Ref	
	10Vdc	100nF	±10%	CL03A104KP3NNW□	Derating	
		25Vdc	180pF	±10%	CL03A181KA3NNW□	Derating
			330pF	±10%	CL03A331KA3NNW□	Derating
			1.8nF	±10%	CL03A182KA3NNW□	Derating

Thickness Max.	Rated Voltage	Capacitance	Capacitance Tolerance	Part Number	Remark
1.35mm	10Vdc	4.7uF	±10%	CL21A475KPFNNW□	
	25Vdc	2.2uF	±10%	CL21A225KAFNNW□	
1.40mm	6.3Vdc	22uF	±20%	CL21A226MQNNW□	
		16Vdc	10uF	±10%	CL21A106KQNNW□
	25Vdc	22uF	±10%	CL21A226KQNNW□	Derating
		22uF	±20%	CL21A226MAQNNW□	Derating
1.45mm	6.3Vdc	47uF	±20%	CL21A476MQYNNW□	Derating

■ Size : 1.00 X 0.50mm (inch : 0402)

Thickness Max.	Rated Voltage	Capacitance	Capacitance Tolerance	Part Number	Remark	
0.55mm	6.3Vdc	220nF	±10%	CL05A224KQ5NNW□		
		330nF	±10%	CL05A334KQ5NNW□		
		470nF	±10%	CL05A474KQ5NNW□		
		1.0uF	±10%	CL05A105KQ5NNW□	Derating	
		1.0uF	±20%	CL05A105MQ5NNW□	Derating	
		2.2uF	±20%	CL05A225MQ5NNW□	Derating Ref	
	10Vdc	100nF	±10%	CL05A104KP5NNW□		
		220nF	±10%	CL05A224KP5NNW□		
		16Vdc	22nF	±10%	CL05A223KQ5NNW□	
			100nF	±10%	CL05A104KQ5NNW□	

■ Size : 3.20 X 1.60mm (inch : 1206)

Thickness Max.	Rated Voltage	Capacitance	Capacitance Tolerance	Part Number	Remark	
1.25mm	10Vdc	10uF	±10%	CL31A106KPLLW□		
1.80mm	6.3Vdc	10uF	±10%	CL31A106KQHNNW□		
		10uF	±20%	CL31A106MQHNNW□		
		22uF	±20%	CL31A226MQHNNW□		
		47uF	±20%	CL31A476MQHNNW□	Derating	
		100uF	±20%	CL31A107MQHNNW□	Derating	
	10Vdc	4.7uF	±10%	CL31A475KPHNNW□		
		10uF	±10%	CL31A106KPHNNW□		
		16Vdc	3.3uF	±10%	CL31A335KOHNNW□	
			4.7uF	±20%	CL31A475MOHNNW□	
			10uF	±10%	CL31A106KOHNNW□	
25Vdc	10uF	±20%	CL31A106MOHNNW□			
	22uF	±20%	CL31A226MOHNNW□	Derating		
	10uF	±10%	CL31A106KAHNNW□			
	22uF	±10%	CL31A226KAHNNW□	Derating		

■ Size : 1.60 X 0.80mm (inch : 0603)

Thickness Max.	Rated Voltage	Capacitance	Capacitance Tolerance	Part Number	Remark
0.90mm	6.3Vdc	470nF	±10%	CL10A474KQ8NNW□	
		1.0uF	±10%	CL10A105KQ8NNW□	
		2.2uF	±10%	CL10A225KQ8NNW□	
		4.7uF	±10%	CL10A475KQ8NNW□	
		10uF	±10%	CL10A106KQ8NNW□	Ref
		10uF	±20%	CL10A106MQ8NNW□	Ref
	10Vdc	220nF	±10%	CL10A224KP8NNW□	
		470nF	±10%	CL10A474KP8NNW□	
		1.0uF	±10%	CL10A105KP8NNW□	
		2.2uF	±10%	CL10A225KP8NNW□	
		10uF	±10%	CL10A106KP8NNW□	Derating Ref
		16Vdc	1.0uF	±10%	CL10A105KQ8NNW□
	4.7uF		±10%	CL10A475KQ8NNW□	Derating

■ Size : 3.20 X 2.50mm (inch : 1210)

Thickness Max.	Rated Voltage	Capacitance	Capacitance Tolerance	Part Number	Remark
0.95mm	16Vdc	10uF	±10%	CL32A106KQCLNW□	
1.70mm	16Vdc	10uF	±10%	CL32A106KOTLNW□	
2.00mm	25Vdc	10uF	±10%	CL32A106KAULNW□	
2.20mm	10Vdc	10uF	±10%	CL32A106KPINNW□	
	25Vdc	10uF	±20%	CL32A106MAILNW□	
2.70mm	6.3Vdc	22uF	±20%	CL32A226MQJNNW□	
		47uF	±20%	CL32A476MQJNNW□	
		22uF	±20%	CL32A226MPJNNW□	
		47uF	±20%	CL32A476MPJNNW□	Derating
	10Vdc	10uF	±20%	CL32A106MOJNNW□	
		22uF	±10%	CL32A226KQJNNW□	
		22uF	±20%	CL32A226MOJNNW□	
		47uF	±10%	CL32A476KQJNNW□	
		47uF	±20%	CL32A476MOJNNW□	
		25Vdc	22uF	±10%	CL32A226KAJNNW□
2.80mm	6.3Vdc	100uF	±20%	CL32A107MQVNNW□	Derating
	10Vdc	100uF	±20%	CL32A107MPVNNW□	Derating

■ Size : 2.00 X 1.25mm (inch : 0805)

Thickness Max.	Rated Voltage	Capacitance	Capacitance Tolerance	Part Number	Remark
0.95mm	16Vdc	2.2uF	±10%	CL21A225KQCLNW□	
1.35mm	6.3Vdc	10uF	±10%	CL21A106KQFNNW□	
		10uF	±20%	CL21A106MQFNNW□	
		4.7uF	±10%	CL21A475KQFNNW□	
		4.7uF	±20%	CL21A475MQFNNW□	
	10Vdc	10uF	±10%	CL21A106KPFNNW□	
		2.2uF	±10%	CL21A225KPFNNW□	

■ Size : 4.50 X 3.20mm (inch : 1812)

Thickness Max.	Rated Voltage	Capacitance	Capacitance Tolerance	Part Number	Remark
3.50mm	6.3Vdc	100uF	±20%	CL43A107MQLNNW□	

* □ mark means packaging code. If you want to learn the code or quantity in detail, please see p.148
 In order to move to the page directly, please click the here. ↑

Product Line Up (X6S)

■ Size : 1.00 X 0.50mm (inch : 0402)

Thickness Max.	Rated Voltage	Capacitance	Capacitance Tolerance	Part Number	Remark
0.55mm	10Vdc	1.0uF	±10%	CL05X105KP5NNW□	

■ Size : 3.20 X 1.60mm (inch : 1206)

Thickness Max.	Rated Voltage	Capacitance	Capacitance Tolerance	Part Number	Remark
1.80mm	4.0Vdc	47uF	±20%	CL31X476MRHNNW□	

■ Size : 1.60 X 0.80 (inch : 0603)

Thickness Max.	Rated Voltage	Capacitance	Capacitance Tolerance	Part Number	Remark
0.90mm	6.3Vdc	10uF	±20%	CL10X106MQ8NNW□	

■ Size : 3.20 X 2.50mm (inch : 1210)

Thickness Max.	Rated Voltage	Capacitance	Capacitance Tolerance	Part Number	Remark
2.80mm	6.3Vdc	100uF	±20%	CL32X107MQVNNW□	

■ Size : 2.00 X 1.25mm (inch : 0805)

Thickness Max.	Rated Voltage	Capacitance	Capacitance Tolerance	Part Number	Remark
1.40mm	4.0Vdc	22uF	±20%	CL21X226MRQNNW□	
	6.3Vdc	22uF	±20%	CL21X226MQQNNW□	

※ □ mark means packaging code. If you want to learn the code or quantity in detail, please see p.148
In order to move to the page directly, please click the here. ↑

Product Line Up (X7R)

■ Size : 0.60 X 0.30mm (inch : 0201)

Thickness Max.	Rated Voltage	Capacitance	Capacitance Tolerance	Part Number	Remark
0.33mm	10Vdc	10nF	±10%	CL03B103KP3NNW□	
		25Vdc	330pF	±10%	CL03B331KA3NNW□
		470pF	±10%	CL03B471KA3NNW□	
		1.00nF	±10%	CL03B102KA3NNW□	
		2.20nF	±10%	CL03B222KA3NNW□	

■ Size : 1.00 X 0.50mm (inch : 0402)

Thickness Max.	Rated Voltage	Capacitance	Capacitance Tolerance	Part Number	Remark	
0.55mm	6.3Vdc	220nF	±10%	CL05B224KQ5NNW□		
		470nF	±10%	CL05B474KQ5NNW□	Ref.	
	10Vdc	33nF	±10%	CL05B333KP5NNW□		
		100nF	±10%	CL05B104KP5NNW□		
	16Vdc	1.0nF	±10%	CL05B102K05NNW□		
		5.6nF	±10%	CL05B562K05NNW□		
		6.8nF	±10%	CL05B682K05NNW□		
		10nF	±5%	CL05B103J05NNW□		
		10nF	±10%	CL05B103K05NNW□		
		10nF	±20%	CL05B103M05NNW□		
		15nF	±10%	CL05B153K05NNW□		
		22nF	±10%	CL05B223K05NNW□		
		33nF	±10%	CL05B333K05NNW□		
		33nF	±20%	CL05B333M05NNW□		
		47nF	±10%	CL05B473K05NNW□		
		47nF	±20%	CL05B473M05NNW□		
		100nF	±10%	CL05B104K05NNW□		
		25Vdc	560pF	±10%	CL05B561KA5NNW□	
	1.0nF		±10%	CL05B102KA5NNW□		
	4.7nF		±10%	CL05B472KA5NNW□		
	8.2nF		±10%	CL05B822KA5NNW□		
	10nF		±10%	CL05B103KA5NNW□		
	15nF		±10%	CL05B153KA5NNW□		
	18nF		±10%	CL05B183KA5NNW□		
	33nF		±10%	CL05B333KA5NNW□		
	50Vdc		100pF	±10%	CL05B101KB5NNW□	
			330pF	±10%	CL05B331KB5NNW□	
		470pF	±10%	CL05B471KB5NNW□		
		560pF	±10%	CL05B561KB5NNW□		
		680pF	±10%	CL05B681KB5NNW□		
		820pF	±10%	CL05B821KB5NNW□		
		1.0nF	±10%	CL05B102KB5NNW□		
		1.5nF	±10%	CL05B152KB5NNW□		
		1.8nF	±10%	CL05B182KB5NNW□		
		2.2nF	±5%	CL05B222JB5NNW□		
		2.2nF	±10%	CL05B222KB5NNW□		
		2.7nF	±10%	CL05B272KB5NNW□		
		3.3nF	±10%	CL05B332KB5NNW□		
		3.9nF	±10%	CL05B392KB5NNW□		
		5.6nF	±10%	CL05B562KB5NNW□		
		6.8nF	±10%	CL05B682KB5NNW□		
	8.2nF	±10%	CL05B822KB5NNW□			
	10nF	±10%	CL05B103KB5NNW□			

■ Size : 1.60 X 0.80mm (inch : 0603)

Thickness Max.	Rated Voltage	Capacitance	Capacitance Tolerance	Part Number	Remark	
0.90mm	10Vdc	220nF	±10%	CL10B224KP8NNW□		
		330nF	±10%	CL10B334KP8NNW□		
		2.2uF	±10%	CL10B225KP8NNW□	Ref.	
	16Vdc	18nF	±10%	CL10B183K08NNW□		
		22nF	±10%	CL10B223K08NNW□		
		27nF	±10%	CL10B273K08NNW□		
		33nF	±10%	CL10B333K08NNW□		
		47nF	±10%	CL10B473K08NNW□		
		100nF	±10%	CL10B104K08NNW□		
		100nF	±20%	CL10B104M08NNW□		
		120nF	±10%	CL10B124K08NNW□		
		150nF	±10%	CL10B154K08NNW□		
		220nF	±10%	CL10B224K08NNW□		
		330nF	±10%	CL10B334K08NNW□		
		470nF	±10%	CL10B474K08NNW□		
		1.0uF	±20%	CL10B105M08NNW□		
		25Vdc	18nF	±10%	CL10B183KA8NNW□	
	22nF		±10%	CL10B223KA8NNW□		
	27nF		±10%	CL10B273KA8NNW□		
	47nF		±10%	CL10B473KA8NNW□		
	100nF		±5%	CL10B104JA8NNW□		
	100nF		±10%	CL10B104KA8NNW□		
	100nF		±20%	CL10B104MA8NNW□		
	470nF		±10%	CL10B474KA8NNW□		
	1.0uF		±10%	CL10B105KA8NNW□		
	50Vdc		100pF	±10%	CL10B101KB8NNW□	
			150pF	±10%	CL10B151KB8NNW□	
			220pF	±10%	CL10B221KB8NNW□	
			270pF	±10%	CL10B271KB8NNW□	
			330pF	±10%	CL10B331KB8NNW□	
		470pF	±10%	CL10B471KB8NNW□		
		560pF	±10%	CL10B561KB8NNW□		
		680pF	±10%	CL10B681KB8NNW□		
		1.0nF	±5%	CL10B102JB8NNW□		
		1.0nF	±10%	CL10B102KB8NNW□		
		1.2nF	±10%	CL10B122KB8NNW□		
		1.5nF	±10%	CL10B152KB8NNW□		
		1.8nF	±10%	CL10B182KB8NNW□		
		2.2nF	±10%	CL10B222KB8NNW□		
		2.7nF	±10%	CL10B272KB8NNW□		
		3.3nF	±10%	CL10B332KB8NNW□		
	4.7nF	±10%	CL10B472KB8NNW□			
	5.6nF	±10%	CL10B562KB8NNW□			
	5.6nF	±20%	CL10B562MB8NNW□			
	6.8nF	±10%	CL10B682KB8NNW□			
	10nF	±10%	CL10B103KB8NNW□			
	12nF	±10%	CL10B123KB8NNW□			
	15nF	±10%	CL10B153KB8NNW□			
	22nF	±10%	CL10B223KB8NNW□			
	33nF	±10%	CL10B333KB8NNW□			
47nF	±10%	CL10B473KB8NNW□				
100nF	±10%	CL10B104KB8NNW□				
100Vdc	100nF	±10%	CL10B104KC8NNW□			

※ □ mark means packaging code. If you want to learn the code or quantity in detail, please see p.148

In order to move to the page directly, please click the here. ↑

Product Line Up (X7R)

■ Size : 2.00 X 1.25mm (inch : 0805)

Thickness Max.	Rated Voltage	Capacitance	Capacitance Tolerance	Part Number	Remark	
0.75mm	16Vdc	150nF	±10%	CL21B154KOANNW□		
		25Vdc	10nF	±10%	CL21B103KAANNW□	
	50Vdc	390pF	±10%	CL21B391KBANNW□		
		1.0nF	±10%	CL21B102KBANNW□		
		2.2nF	±10%	CL21B222KBANNW□		
		3.3nF	±5%	CL21B332JBANNW□		
		3.3nF	±10%	CL21B332KBANNW□		
		4.7nF	±10%	CL21B472KBANNW□		
		6.8nF	±10%	CL21B682KBANNW□		
		10nF	±10%	CL21B103KBANNW□		
		10nF	±20%	CL21B103MBANNW□		
		15nF	±10%	CL21B153KBANNW□		
	22nF	±10%	CL21B223KBANNW□			
	33nF	±10%	CL21B333KBANNW□			
	100Vdc	330pF	±10%	CL21B331KCANNW□		
		1.0nF	±10%	CL21B102KCANNW□		
2.2nF		±10%	CL21B222KCANNW□			
0.95mm	16Vdc	100nF	±5%	CL21B104JOCNNW□		
		220nF	±10%	CL21B224KOCNNW□		
		330nF	±10%	CL21B334KOCNNW□		
	25Vdc	100nF	±10%	CL21B104KACNNW□		
		50Vdc	47nF	±10%	CL21B473KBCNNW□	
			100nF	±10%	CL21B104KBCNNW□	
	200Vdc	100nF	±20%	CL21B104MBCNNW□		
		1.0nF	±10%	CL21B102KDCNNW□		
		2.2nF	±10%	CL21B222KDCNNW□		
		4.7nF	±10%	CL21B472KDCNNW□		
1.35mm	10Vdc	1.0uF	±10%	CL21B105KPFNNW□		
		1.0uF	±20%	CL21B105MPFNNW□		
		2.2uF	±10%	CL21B225KPFNNW□		
	16Vdc	470nF	±10%	CL21B474KOFNNW□		
		680nF	±10%	CL21B684KOFNNW□		
		1.0uF	±10%	CL21B105KOFNNW□		
		2.2uF	±10%	CL21B225KOFNNW□		
		4.7uF	±10%	CL21B475KOFNNW□	Ref.	
	25Vdc	150nF	±10%	CL21B154KAFNNW□		
		220nF	±10%	CL21B224KAFNNW□		
		470nF	±10%	CL21B474KAFNNW□		
		1.0uF	±10%	CL21B105KAFNNW□		
		2.2uF	±10%	CL21B225KAFNNW□		
	50Vdc	220nF	±10%	CL21B224KBFNNW□		
		330nF	±10%	CL21B334KBFNNW□		
		470nF	±10%	CL21B474KBFNNW□		
680nF		±10%	CL21B684KBFNNW□			
100Vdc	18nF	±10%	CL21B183KCFNNW□			
	22nF	±10%	CL21B223KCFNNW□			
	47nF	±10%	CL21B473KCFNNW□			
	100nF	±10%	CL21B104KCFNNW□			
1.40mm	6.3Vdc	10uF	±10%	CL21B106KQNNW□		
	10Vdc	10uF	±10%	CL21B106KPQNNW□		

■ Size : 3.20 X 1.60mm (inch : 1206)

Thickness Max.	Rated Voltage	Capacitance	Capacitance Tolerance	Part Number	Remark	
1.00mm	16Vdc	470nF	±10%	CL31B474KOCNNW□		
		47nF	±10%	CL31B473KOCNNW□		
	50Vdc	100nF	±5%	CL31B104JBCNNW□		
		100nF	±10%	CL31B104KBCNNW□		
		10nF	±10%	CL31B103KBCNNW□		
		120nF	±10%	CL31B124KBCNNW□		
		150nF	±10%	CL31B154KBCNNW□		
		1.0nF	±10%	CL31B102KBCNNW□		
		3.3nF	±5%	CL31B332JBCNNW□		
		47nF	±10%	CL31B473KBCNNW□		
		100Vdc	10nF	±5%	CL31B103JCCNNW□	
			10nF	±20%	CL31B103MCCNNW□	
	15nF		±10%	CL31B153KCCNNW□		
	1.0nF		±10%	CL31B102KCCNNW□		
	22nF		±10%	CL31B223KCCNNW□		
	33nF		±10%	CL31B333KCCNNW□		
	47nF		±10%	CL31B473KCCNNW□		
	47nF		±20%	CL31B473MCCNNW□		
	1.25mm	25Vdc	1.0uF	±10%	CL31B105KAPLNW□	Derating
		1.40mm	10Vdc	2.2uF	±10%	CL31B225KPFNNW□
16Vdc	1.0uF			±10%	CL31B105KOFNNW□	
50Vdc	1.0uF		±20%	CL31B105MOFNNW□		
	220nF		±10%	CL31B224KBFNNW□		
	220nF		±20%	CL31B224MBFNNW□		
100Vdc	330nF		±10%	CL31B334KBFNNW□		
	100nF		±10%	CL31B104KCFNNW□		
200Vdc	33nF		±10%	CL31B333KDFNNW□		
	47nF		±10%	CL31B473KDFNNW□		
500Vdc	4.7nF		±10%	CL31B472KGFNNW□		
	6.8nF	±10%	CL31B682KGFNNW□			
1.80mm	6.3Vdc	22uF	±10%	CL31B226KQHNNW□		
	10Vdc	10uF	±10%	CL31B106KPHNNW□		
		22uF	±10%	CL31B226KPHNNW□		
		4.7uF	±10%	CL31B475KPHNNW□		
	16Vdc	10uF	±10%	CL31B106KOHNNW□		
		2.2uF	±10%	CL31B225KOHNNW□		
		4.7uF	±10%	CL31B475KOHNNW□		
	25Vdc	10uF	±10%	CL31B106KAHNNW□		
		1.0uF	±5%	CL31B105JAHNNW□		
		1.0uF	±10%	CL31B105KAHNNW□		
		1.0uF	±20%	CL31B105MAHNNW□		
		2.2uF	±10%	CL31B225KAHNNW□		
		4.7uF	±10%	CL31B475KAHNNW□		
	50Vdc	1.0uF	±10%	CL31B105KBHNNW□		
		2.2uF	±10%	CL31B225KBHNNW□		
		470nF	±10%	CL31B474KBHNNW□		
100Vdc		1.0uF	±10%	CL31B105KCHNNW□		
200Vdc	68nF	±10%	CL31B683KDHNNW□			
250Vdc	47nF	±10%	CL31B473KEHNNW□			
2kVdc	2.2nF	±10%	CL31B222KJHNNW□	Derating		

※ □ mark means packaging code. If you want to learn the code or quantity in detail, please see p.148
In order to move to the page directly, please click the here. ↑

Product Line Up (X7R)

■ Size : 3.20 X 2.50mm (inch : 1210)

Thickness Max.	Rated Voltage	Capacitance	Capacitance Tolerance	Part Number	Remark
1.45mm	25Vdc	470nF	±10%	CL32B474KAFNNW□	
		470nF	±20%	CL32B474MAFNNW□	
		1.0uF	±10%	CL32B105KAFNNW□	
	50Vdc	100nF	±20%	CL32B104MBFNNW□	
		220nF	±10%	CL32B224KBFNNW□	
		330nF	±10%	CL32B334KBFNNW□	
		470nF	±10%	CL32B474KBFNNW□	
	100Vdc	100nF	±10%	CL32B104KCFNNW□	
		150nF	±10%	CL32B154KCFNNW□	
	500Vdc	22nF	±10%	CL32B223KGFNNW□	
2kVdc		1.0nF	±10%	CL32B102KJFNNW□	
1.80mm	100Vdc	220nF	±10%	CL32B224KCHNNW□	
		330nF	±10%	CL32B334KCHNNW□	
	200Vdc	47nF	±10%	CL32B473KDHNNW□	
	250Vdc	47nF	±10%	CL32B473KEHNNW□	
2.00mm	50Vdc	4.7uF	±10%	CL32B475KBUYNNW□	
2.20mm	16Vdc	4.7uF	±10%	CL32B475KIOINNW□	
	25Vdc	2.2uF	±10%	CL32B225KAINNW□	
	630Vdc	47nF	±10%	CL32B473KHINNW□	
2.70mm	10Vdc	47uF	±10%	CL32B476KPJNNW□	Ref.
		22uF	±10%	CL32B226KOJNNW□	
	16Vdc	22uF	±20%	CL32B226MOJNNW□	
		10uF	±10%	CL32B106KAJNNW□	
		22uF	±10%	CL32B226KAJNNW□	
	25Vdc	22uF	±20%	CL32B226MAJNNW□	
		3.3uF	±10%	CL32B335KBJNNW□	
		10uF	±10%	CL32B106KBJNNW□	
	100Vdc	680nF	±10%	CL32B684KCJNNW□	
		1.0uF	±10%	CL32B105KCJNNW□	
200Vdc	100nF	±10%	CL32B104KDJNNW□		

■ Size : 4.50 X 3.20mm (inch : 1812)

Thickness Max.	Rated Voltage	Capacitance	Capacitance Tolerance	Part Number	Remark
1.45mm	200Vdc	100nF	±10%	CL43B104KDFNNW□	
	1kVdc	10nF	±10%	CL43B103KIFNNW□	Derating
1.80mm	100Vdc	470nF	±10%	CL43B474KCHNNW□	
2.70mm	250Vdc	220nF	±10%	CL43B224KEJNNW□	
	1kVdc	22nF	±10%	CL43B223KIJNNW□	Derating

■ Size : 5.70 X 5.00mm (inch : 2220)

Thickness Max.	Rated Voltage	Capacitance	Capacitance Tolerance	Part Number	Remark
1.80mm	100Vdc	1.0uF	±10%	CL55B105KCHNNW□	

Product Line Up (X7S)

■ Size : 3.20 X 2.50mm (inch : 1210)

Thickness Max.	Rated Voltage	Capacitance	Capacitance Tolerance	Part Number	Remark
2.70mm	50Vdc	10uF	±10%	CL32Y106KBJNNW□	

※ □ mark means packaging code. If you want to learn the code or quantity in detail, please see p.148
 In order to move to the page directly, please click the here. †

Feature



- Soft – Termination relaxes the applied thermal / mechanical stresses by ductile properties of metal – polymer composites.
- Can be applied to power (SMPS, DC – DC Converter) and industrial equipment
- ZNW, SNW series : Metal Epoxy
- Speical outgoing inspection for industrial application (HALT, etc)

Application

- Power(SMPS, DC – DC converter)
- Ideal for decoupling and filtering applications(Class II : X7R / X6S)

Structure and Dimensions

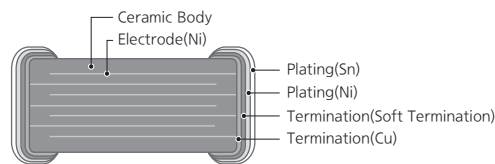
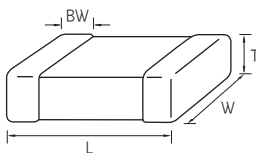

Size Code	EIA Code	Dimension(mm)				
		L	W	T	Thickness Code	BW
21	0805	2.00±0.10	1.25±0.10	0.65±0.10	A	0.50+0.20/-0.30
		2.00±0.10	1.25±0.10	0.85±0.10	C	
		2.00±0.10	1.25±0.10	1.15±0.10	M	
		2.00±0.10	1.25±0.10	1.25±0.10	F	
31	1206	3.20±0.15	1.60±0.15	0.85±0.15	C	0.50±0.30
		3.20±0.15	1.60±0.15	1.25±0.15	F	
		3.20±0.20	1.60±0.20	1.60±0.20	H	
32	1210	3.20±0.30	2.50±0.20	1.25±0.20	F	0.60±0.30
		3.20±0.30	2.50±0.20	1.60±0.20	H	
		3.20±0.30	2.50±0.20	2.00±0.20	I	
		3.20±0.30	2.50±0.20	2.50±0.20	J	

Industrial Capacitance Table (X6S / X7R)

Size inch (mm)	Rated Voltage (Vdc)	Capacitance									
		nF				uF					
		68	100	220	470	1.0	2.2	4.7	10	22	47
0805(2012)	100										
1206(3216)	100										
1210 (3225)	16										X6S
	100										

Product Line Up (X6S)

■ Size : 3.20 X 2.50mm (inch : 1210)

Thickness Max.	Rated Voltage	Capacitance	Capacitance Tolerance	Part Number	Remark
2.80mm	10Vdc	47uF	±10%	CL32X476KOVZNW□	

Product Line Up (X7R)

■ Size : 2.00 X 1.25mm (inch : 0805)

Thickness Max.	Rated Voltage	Capacitance	Capacitance Tolerance	Part Number	Remark
1.35mm	100Vdc	100nF	±10%	CL21B104KCFSNW□	
		220nF	±10%	CL21B224KCFSNW□	

■ Size : 3.20 X 1.60mm (inch : 1206)

Thickness Max.	Rated Voltage	Capacitance	Capacitance Tolerance	Part Number	Remark
1.80mm	100Vdc	1.0uF	±10%	CL31B105KCHSNW□	
		2.2uF	±10%	CL31B225KCHSNW□	

■ Size : 3.20 X 2.50mm (inch : 1210)

Thickness Max.	Rated Voltage	Capacitance	Capacitance Tolerance	Part Number	Remark
2.70mm	100Vdc	1.0uF	±10%	CL32B105KCJSNW□	
		2.2uF	±10%	CL32B225KCJSNW□	
2.80mm	100Vdc	4.7uF	±10%	CL32B475KCVZNW□	

※ □ mark means packaging code. If you want to learn the code or quantity in detail, please see p.148

In order to move to the page directly, please click the here. ↑

Feature



- Rated voltage 6.3V~100V,
Temperature range -55°C to +125°C (COG / X7R), -55°C to +105°C (X6S), -55°C to +85°C (X5R),
Case size 0201 to 1210.
- Special outgoing inspection for Power application
(Bending Test : Sampling Test upto 2mm : X7R, 3mm : COG)

Application

- Power supply (SMPS, DC – DC converter)
- Ideal for decoupling and filtering applications (Class II : X7R / X6S / X5R)
- Impedance matching, tuning, coupling in high frequency circuit (Class I : COG)

Structure and Dimensions

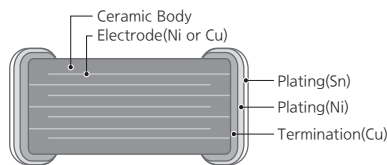
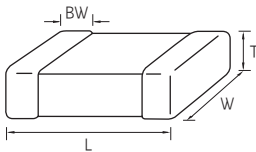

Size Code	EIA Code	Dimension(mm)				
		L	W	T	Thickness Code	BW
03	0201	0.60±0.03	0.30±0.03	0.30±0.03	3	0.15±0.05
05	0402	1.00±0.05	0.50±0.05	0.50±0.05	5	0.25±0.10
10	0603	1.60±0.10	0.80±0.10	0.80±0.10	8	0.30±0.20
21	0805	2.00±0.10	1.25±0.10	0.65±0.10	A	0.50+0.20/-0.30
		2.00±0.10	1.25±0.10	0.85±0.10	C	
		2.00±0.10	1.25±0.10	1.15±0.10	M	
		2.00±0.10	1.25±0.10	1.25±0.10	F	
31	1206	3.20±0.15	1.60±0.15	0.85±0.15	C	0.50±0.30
		3.20±0.15	1.60±0.15	1.25±0.15	F	
		3.20±0.20	1.60±0.20	1.60±0.20	H	
32	1210	3.20±0.30	2.50±0.20	1.25±0.20	F	0.60±0.30
		3.20±0.30	2.50±0.20	1.60±0.20	H	
		3.20±0.30	2.50±0.20	2.00±0.20	I	
		3.20±0.30	2.50±0.20	2.50±0.20	J	

Industrial Capacitance Table (X5R)

Size inch (mm)	Rated Voltage (Vdc)	Capacitance											
		nF			uF								
		100	220	470	1.0	2.2	4.7	10	22	47	100	150	220
0201 (0603)	4.0												
	6.3												
	10												
0402 (1005)	4.0												
	6.3												
	10												
	16												
0603 (1608)	6.3												
	10												
	16												
	25												
	50												
0805 (2012)	6.3												
	10												
	16												
	25												
1206 (3216)	6.3												
	10												
	16												
	25							3.3					
	50												
1210 (3225)	6.3												
	10												
	16												
	25												

Industrial Capacitance Table (X6S)

Size inch (mm)	Rated Voltage (Vdc)	Capacitance(uF)											
		0.1	0.22	0.47	1.0	2.2	4.7	10	22	47	100	220	
0402(1005)	6.3												
0805 (2012)	4.0												
	25												
1206(3216)	6.3												

Product Line Up (COG)

■ Size : 1.00 X 0.50mm (inch : 0402)

Thickness Max.	Rated Voltage	Capacitance	Capacitance Tolerance	Part Number
0.55mm	25Vdc	1.0nF	±5%	CL05C102JA5NFN □
	50Vdc	0.5pF	±0.1pF	CL05C0R5BB5NFN □
		0.5pF	±0.25pF	CL05C0R5CB5NFN □
		1.0pF	±0.25pF	CL05C010CB5NFN □
		2.0pF	±0.25pF	CL05C020CB5NFN □
		10pF	±0.25pF	CL05C100CB5NFN □
		10pF	±5%	CL05C100JB5NFN □
		15pF	±5%	CL05C150JB5NFN □
		18pF	±5%	CL05C180JB5NFN □
		20pF	±5%	CL05C200JB5NFN □
		22pF	±5%	CL05C220JB5NFN □
		27pF	±5%	CL05C270JB5NFN □
		33pF	±5%	CL05C330JB5NFN □
		47pF	±5%	CL05C470JB5NFN □
		56pF	±5%	CL05C560JB5NFN □
		68pF	±5%	CL05C680JB5NFN □
		100pF	±5%	CL05C101JB5NFN □
		120pF	±5%	CL05C121JB5NFN □
		150pF	±5%	CL05C151JB5NFN □
		180pF	±5%	CL05C181JB5NFN □
220pF	±5%	CL05C221JB5NFN □		
270pF	±5%	CL05C271JB5NFN □		
330pF	±5%	CL05C331JB5NFN □		
680pF	±5%	CL05C681JB5NFN □		

Thickness Max.	Rated Voltage	Capacitance	Capacitance Tolerance	Part Number
0.90mm	50Vdc	180pF	±5%	CL10C181JB8NFN □
		200pF	±5%	CL10C201JB8NFN □
		220pF	±5%	CL10C221JB8NFN □
		270pF	±5%	CL10C271JB8NFN □
		330pF	±5%	CL10C331JB8NFN □
		390pF	±5%	CL10C391JB8NFN □
		430pF	±5%	CL10C431JB8NFN □
		470pF	±5%	CL10C471JB8NFN □
		560pF	±5%	CL10C561JB8NFN □
		680pF	±5%	CL10C681JB8NFN □
	100Vdc	1.0nF	±5%	CL10C102JB8NFN □
		1.2nF	±5%	CL10C122JB8NFN □
		1.5nF	±5%	CL10C152JB8NFN □
		1.8nF	±5%	CL10C182JB8NFN □
		2.2nF	±5%	CL10C222JB8NFN □
		2.7nF	±5%	CL10C272JB8NFN □
		3.3nF	±5%	CL10C332JB8NFN □
		47pF	±5%	CL10C470JC8NFN □
		220pF	±5%	CL10C221JC8NFN □
		470pF	±5%	CL10C471JC8NFN □
250Vdc	470pF	±5%	CL10C471JE8NFN □	

■ Size : 2.00 X 1.25mm (inch : 0805)

■ Size : 1.60 X 0.80mm (inch : 0603)

Thickness Max.	Rated Voltage	Capacitance	Capacitance Tolerance	Part Number
0.90mm	25Vdc	1.0nF	±5%	CL10C102JA8NFN □
	50Vdc	0.5pF	±0.25pF	CL10C0R5CB8NFN □
		1.0pF	±0.25pF	CL10C010CB8NFN □
		3.9pF	±0.25pF	CL10C3R9CB8NFN □
		4.7pF	±0.25pF	CL10C4R7CB8NFN □
		5.0pF	±0.1pF	CL10C050BB8NFN □
		5.0pF	±0.25pF	CL10C050CB8NFN □
		10pF	±5%	CL10C100JB8NFN □
		12pF	±1%	CL10C120FB8NFN □
		12pF	±5%	CL10C120JB8NFN □
		15pF	±5%	CL10C150JB8NFN □
		18pF	±5%	CL10C180JB8NFN □
		20pF	±5%	CL10C200JB8NFN □
		22pF	±5%	CL10C220JB8NFN □
		27pF	±5%	CL10C270JB8NFN □
		33pF	±5%	CL10C330JB8NFN □
		39pF	±5%	CL10C390JB8NFN □
		47pF	±5%	CL10C470JB8NFN □
		56pF	±5%	CL10C560JB8NFN □
		62pF	±5%	CL10C620JB8NFN □
68pF	±5%	CL10C680JB8NFN □		
82pF	±5%	CL10C820JB8NFN □		
100pF	±5%	CL10C101JB8NFN □		
120pF	±5%	CL10C121JB8NFN □		
150pF	±5%	CL10C151JB8NFN □		

Thickness Max.	Rated Voltage	Capacitance	Capacitance Tolerance	Part Number
0.75mm	50Vdc	0.5pF	±0.25pF	CL21C0R5CBANFN □
		1.0pF	±0.25pF	CL21C010CBANFN □
		1.8pF	±0.25pF	CL21C1R8CBANFN □
		2.0pF	±0.25pF	CL21C020CBANFN □
		3.0pF	±0.25pF	CL21C030CBANFN □
		3.9pF	±0.25pF	CL21C3R9CBANFN □
		4.0pF	±0.25pF	CL21C040CBANFN □
		4.7pF	±0.25pF	CL21C4R7CBANFN □
		6.0pF	±0.5pF	CL21C060DBANFN □
		7.0pF	±0.5pF	CL21C070DBANFN □
		7.5pF	±0.5pF	CL21C7R5DBANFN □
		8.0pF	±0.5pF	CL21C080DBANFN □
		8.2pF	±0.5pF	CL21C8R2DBANFN □
		10pF	±5%	CL21C100JBANFN □
		12pF	±5%	CL21C120JBANFN □
		15pF	±5%	CL21C150JBANFN □
		18pF	±5%	CL21C180JBANFN □
		20pF	±5%	CL21C200JBANFN □
		22pF	±5%	CL21C220JBANFN □
		25pF	±5%	CL21C250JBANFN □
27pF	±5%	CL21C270JBANFN □		
30pF	±5%	CL21C300JBANFN □		
33pF	±5%	CL21C330JBANFN □		
39pF	±5%	CL21C390JBANFN □		
47pF	±5%	CL21C470JBANFN □		
51pF	±5%	CL21C510JBANFN □		
56pF	±5%	CL21C560JBANFN □		

※ □ mark means packaging code. If you want to learn the code or quantity in detail, please see p.148

In order to move to the page directly, please click the here. ↑

Product Line Up (COG)

■ Size : 2.00 X 1.25mm (inch : 0805)

Thickness Max.	Rated Voltage	Capacitance	Capacitance Tolerance	Part Number		
0.75mm	50Vdc	68pF	±5%	CL21C680JBCNFN□		
		82pF	±5%	CL21C820JBCNFN□		
		100pF	±5%	CL21C101JBCNFN□		
		120pF	±5%	CL21C121JBCNFN□		
		150pF	±5%	CL21C151JBCNFN□		
		180pF	±5%	CL21C181JBCNFN□		
		200pF	±5%	CL21C201JBCNFN□		
		220pF	±5%	CL21C221JBCNFN□		
		240pF	±5%	CL21C241JBCNFN□		
		270pF	±5%	CL21C271JBCNFN□		
		300pF	±5%	CL21C301JBCNFN□		
		330pF	±5%	CL21C331JBCNFN□		
		390pF	±5%	CL21C391JBCNFN□		
		470pF	±5%	CL21C471JBCNFN□		
	560pF	±5%	CL21C561JBCNFN□			
	100Vdc	22pF	±5%	CL21C220JCANFN□		
		33pF	±5%	CL21C330JCANFN□		
		100pF	±5%	CL21C101JCANFN□		
		0.95mm	50Vdc	680pF	±5%	CL21C681JBCNFN□
				820pF	±5%	CL21C821JBCNFN□
1.0nF				±5%	CL21C102JBCNFN□	
100Vdc	470pF		±5%	CL21C471JCCNFN□		
	200Vdc		47pF	±5%	CL21C470JDCNFN□	
			100pF	±5%	CL21C101JDCNFN□	
220pF		±5%	CL21C221JDCNFN□			
1.35mm	50Vdc	4.7nF	±5%	CL21C472JAFNFN□		
		1.5nF	±5%	CL21C152JBFNFN□		
		1.8nF	±5%	CL21C182JBFNFN□		
		2.2nF	±5%	CL21C222JBFNFN□		
		3.9nF	±5%	CL21C392JBFNFN□		
	200Vdc	4.7nF	±5%	CL21C472JBFNFN□		
		10nF	±5%	CL21C103JBFNFN□		
		1.0nF	±5%	CL21C102JDFNFN□		

■ Size : 3.20 X 1.60mm (inch : 1206)

Thickness Max.	Rated Voltage	Capacitance	Capacitance Tolerance	Part Number
1.00mm	50Vdc	12pF	±5%	CL31C120JBCNFN□
		15pF	±5%	CL31C150JBCNFN□
		18pF	±5%	CL31C180JBCNFN□
		22pF	±5%	CL31C220JBCNFN□
		33pF	±5%	CL31C330JBCNFN□
		47pF	±5%	CL31C470JBCNFN□
		56pF	±5%	CL31C560JBCNFN□
		100pF	±5%	CL31C101JBCNFN□
		100pF	±10%	CL31C101KBCNFN□
		120pF	±5%	CL31C121JBCNFN□
		220pF	±5%	CL31C221JBCNFN□
		270pF	±5%	CL31C271JBCNFN□
		330pF	±5%	CL31C331JBCNFN□
		470pF	±5%	CL31C471JBCNFN□
		560pF	±5%	CL31C561JBCNFN□

Thickness Max.	Rated Voltage	Capacitance	Capacitance Tolerance	Part Number		
1.00mm	50Vdc	1.0nF	±5%	CL31C102JBCNFN□		
		1.5nF	±5%	CL31C152JBCNFN□		
		100Vdc	100pF	±5%	CL31C101JCCNFN□	
			330pF	±5%	CL31C331JCCNFN□	
			470pF	±5%	CL31C471JCCNFN□	
		200Vdc	100pF	±5%	CL31C101JDCNFN□	
	220pF		±5%	CL31C221JDCNFN□		
	1.40mm		50Vdc	4.7nF	±5%	CL31C472JBFNFN□
		500Vdc		33pF	±5%	CL31C330JGFNFN□
			47pF	±5%	CL31C470JGFNFN□	
			100pF	±5%	CL31C101JGFNFN□	
			180pF	±5%	CL31C181JGFNFN□	
			220pF	±5%	CL31C221JGFNFN□	
			330pF	±5%	CL31C331JGFNFN□	
			390pF	±5%	CL31C391JGFNFN□	
			470pF	±5%	CL31C471JGFNFN□	
			560pF	±5%	CL31C561JGFNFN□	
			630Vdc	10pF	±5%	CL31C100JHFNFN□
				15pF	±5%	CL31C150JHFNFN□
				33pF	±5%	CL31C330JHFNFN□
47pF		±5%		CL31C470JHFNFN□		
100pF	±5%	CL31C101JHFNFN□				
150pF	±5%	CL31C151JHFNFN□				
220pF	±5%	CL31C221JHFNFN□				
220pF	±10%	CL31C221KHFNFN□				
1kVdc	330pF	±5%	CL31C331JHFNFN□			
	470pF	±5%	CL31C471JHFNFN□			
	10pF	±5%	CL31C100JIFNFN□			
	18pF	±5%	CL31C180JIFNFN□			
	22pF	±5%	CL31C220JIFNFN□			
	33pF	±5%	CL31C330JIFNFN□			
	47pF	±5%	CL31C470JIFNFN□			
	56pF	±5%	CL31C560JIFNFN□			
	68pF	±5%	CL31C680JIFNFN□			
	100pF	±5%	CL31C101JIFNFN□			
	1.80mm	500Vdc	680pF	±5%	CL31C681JGHFNFN□	
			1.0nF	±5%	CL31C102JGHFNFN□	
			2.2nF	±5%	CL31C222JGHFNFN□	
		630Vdc	680pF	±5%	CL31C681JHHNFN□	
1.0nF			±5%	CL31C102JHHNFN□		
1.2nF			±5%	CL31C122JHHNFN□		
1.5nF			±5%	CL31C152JHHNFN□		
2.2nF			±5%	CL31C222JHHNFN□		
3.3nF			±5%	CL31C332JHHNFN□		
220pF			±5%	CL31C221JHFNFN□		
1kVdc		220pF	±5%	CL31C221JHFNFN□		

■ Size : 4.50 X 3.20mm (inch : 1812)

Thickness Max.	Rated Voltage	Capacitance	Capacitance Tolerance	Part Number
2.70mm	630Vdc	22nF	±5%	CL43C223JHJNFN□

※ □ mark means packaging code. If you want to learn the code or quantity in detail, please see p.148

In order to move to the page directly, please click the here. ↑

Product Line Up (X5R)

■ Size : 1.00 X 0.50mm (inch : 0402)

Thickness Max.	Rated Voltage	Capacitance	Capacitance Tolerance	Part Number	Remark
0.55mm	4.0Vdc	2.2uF	±20%	CL05A225MR5NFN □	Derating
		470nF	±10%	CL05A474KQ5NFN □	
	6.3Vdc	1.0uF	±10%	CL05A105KQ5NFN □	Derating
		2.2uF	±10%	CL05A225KQ5NFN □	Derating Ref.
		10Vdc	100nF	±10%	CL05A104KP5NFN □
	10Vdc	220nF	±10%	CL05A224KP5NFN □	
		470nF	±10%	CL05A474KP5NFN □	
	16Vdc	1.0uF	±10%	CL05A105K05NFN □	Derating

■ Size : 1.60 X 0.80mm (inch : 0603)

Thickness Max.	Rated Voltage	Capacitance	Capacitance Tolerance	Part Number	Remark	
0.90mm	6.3Vdc	1.0uF	±10%	CL10A105KQ8NFN □		
		2.2uF	±10%	CL10A225KQ8NFN □		
	10Vdc	1.0uF	±10%	CL10A105KP8NFN □		
		2.2uF	±10%	CL10A225KP8NFN □		
		4.7uF	±10%	CL10A475KP8NFN □		
		10uF	±10%	CL10A106KP8NFN □	Derating Ref.	
	10Vdc	10uF	±20%	CL10A106MP8NFN □	Derating Ref.	
		16Vdc	1.0uF	±10%	CL10A105K08NFN □	
		16Vdc	2.2uF	±10%	CL10A225K08NFN □	
	4.7uF		±10%	CL10A475K08NFN □	Derating	
	25Vdc	470nF	±10%	CL10A474K8NFN □		
		1.0uF	±10%	CL10A105K8NFN □		
	50Vdc	1.0uF	±10%	CL10A105K8NFN □		

■ Size : 2.00 X 1.25mm (inch : 0805)

Thickness Max.	Rated Voltage	Capacitance	Capacitance Tolerance	Part Number	Remark
1.35mm	6.3Vdc	4.7uF	±10%	CL21A475KQFNFN □	
		10uF	±10%	CL21A106KQFNFN □	
	10Vdc	2.2uF	±10%	CL21A225KPFNFN □	
		4.7uF	±10%	CL21A475KPFNFN □	
		10uF	±10%	CL21A106KPFNFN □	
16Vdc	2.2uF	±10%	CL21A225K0FNFN □		
1.40mm	6.3Vdc	22uF	±10%	CL21A226KQNFN □	
	16Vdc	10uF	±10%	CL21A106KQNFN □	Derating
	25Vdc	4.7uF	±10%	CL21A475KAQNFN □	
22uF		±20%	CL21A226MAQNFN □	Derating	
1.45mm	25Vdc	10uF	±10%	CL21A106KAYNFN □	Derating

■ Size : 3.20 X 1.60mm (inch : 1206)

Thickness Max.	Rated Voltage	Capacitance	Capacitance Tolerance	Part Number	Remark	
0.95mm	16Vdc	22uF	±10%	CL31A226KOCFLFN □	Derating	
		22uF	±20%	CL31A226MOCFLFN □	Derating	
1.80mm	6.3Vdc	10uF	±10%	CL31A106KQHNFN □		
		22uF	±10%	CL31A226KQHNFN □		
		22uF	±20%	CL31A226MQHNFN □		
		10Vdc	4.7uF	±10%	CL31A475KPHNFN □	
	10Vdc	10uF	±10%	CL31A106KPHNFN □		
		16Vdc	4.7uF	±10%	CL31A475KOHNFN □	
			4.7uF	±20%	CL31A475MOHNFN □	
		10uF	±10%	CL31A106KOHNFN □		
	16Vdc	22uF	±10%	CL31A226KOHNFN □		
		25Vdc	3.3uF	±10%	CL31A335KAHNFN □	
			4.7uF	±10%	CL31A475KAHNFN □	
		10uF	±10%	CL31A106KAHNFN □		
	50Vdc	22uF	±10%	CL31A226KAHNFN □	Derating	
		10uF	±10%	CL31A106KBHNFN □		



■ Size : 3.20 X 2.50mm (inch : 1210)

Thickness Max.	Rated Voltage	Capacitance	Capacitance Tolerance	Part Number	Remark	
2.70mm	6.3Vdc	22uF	±10%	CL32A226KQJNFN □		
		22uF	±20%	CL32A226MQJNFN □		
	10Vdc	22uF	±10%	CL32A226KPJNFN □		
		16Vdc	10uF	±10%	CL32A106KQJNFN □	
	16Vdc	22uF	±10%	CL32A226KQJNFN □		
		25Vdc	10uF	±10%	CL32A106KAJNFN □	
			22uF	±10%	CL32A226KAJNFN □	
2.80mm	6.3Vdc	100uF	±20%	CL32A107MQVNFN □	Derating	
		150uF	±20%	CL32A157MQVNFN □	Derating	



※ □ mark means packaging code. If you want to learn the code or quantity in detail, please see p.148
In order to move to the page directly, please click the here. ↑

Product Line Up (X6S)

■ Size : 1.00 X 0.50mm (inch : 0402)

Thickness Max.	Rated Voltage	Capacitance	Capacitance Tolerance	Part Number	Remark
0.55mm	6.3Vdc	1.0uF	±10%	CL05X105KQ5NFN□	
0.57mm	2.5Vdc	2.2uF	±20%	CL05X225MS5NFN□	

■ Size : 2.00 X 1.25mm (inch : 0805)

Thickness Max.	Rated Voltage	Capacitance	Capacitance Tolerance	Part Number	Remark
1.40mm	4.0Vdc	22uF	±20%	CL21X226MRQNFN□	
1.45mm	25Vdc	10uF	±10%	CL21X106KAYNFN□	

■ Size : 3.20 X 1.60mm (inch : 1206)

Thickness Max.	Rated Voltage	Capacitance	Capacitance Tolerance	Part Number	Remark
1.80mm	6.3Vdc	47uF	±20%	CL31X476MQHNFN□	

※ □ mark means packaging code. If you want to learn the code or quantity in detail, please see p.148
 In order to move to the page directly, please click the here. ↑

Product Line Up (X7R)

■ Size : 0.60 X 0.30mm (inch : 0201)

Thickness Max.	Rated Voltage	Capacitance	Capacitance Tolerance	Part Number	Remark
0.33mm	10Vdc	4.7nF	±10%	CL03B472KP3NFN □	
		6.8nF	±10%	CL03B682KP3NFN □	
		10nF	±10%	CL03B103KP3NFN □	

■ Size : 1.00 X 0.50mm (inch : 0402)

Thickness Max.	Rated Voltage	Capacitance	Capacitance Tolerance	Part Number	Remark	
0.55mm	10Vdc	100nF	±10%	CL05B104KP5NFN □		
		16Vdc	330pF	±10%	CL05B331K05NFN □	
			8.2nF	±10%	CL05B822K05NFN □	
			10nF	±10%	CL05B103K05NFN □	
			15nF	±10%	CL05B153K05NFN □	
			22nF	±10%	CL05B223K05NFN □	
			27nF	±10%	CL05B273K05NFN □	
			33nF	±10%	CL05B333K05NFN □	
			68nF	±10%	CL05B683K05NFN □	
			100nF	±10%	CL05B104K05NFN □	
	25Vdc	4.7nF	±10%	CL05B472KA5NFN □		
		5.6nF	±10%	CL05B562KA5NFN □		
		10nF	±10%	CL05B103KA5NFN □		
		22nF	±10%	CL05B223KA5NFN □		
	50Vdc	270pF	±10%	CL05B271KB5NFN □		
		330pF	±10%	CL05B331KB5NFN □		
		390pF	±10%	CL05B391KB5NFN □		
		470pF	±10%	CL05B471KB5NFN □		
		560pF	±10%	CL05B561KB5NFN □		
		680pF	±10%	CL05B681KB5NFN □		
		820pF	±10%	CL05B821KB5NFN □		
		1.0nF	±5%	CL05B102JB5NFN □		
		1.0nF	±10%	CL05B102KB5NFN □		
		1.5nF	±10%	CL05B152KB5NFN □		
		2.2nF	±10%	CL05B222KB5NFN □		
		3.3nF	±10%	CL05B332KB5NFN □		
		4.7nF	±10%	CL05B472KB5NFN □		
		5.6nF	±10%	CL05B562KB5NFN □		
		10nF	±10%	CL05B103KB5NFN □		

■ Size : 1.60 X 0.80mm (inch : 0603)

Thickness Max.	Rated Voltage	Capacitance	Capacitance Tolerance	Part Number	Remark	
0.90mm	6.3Vdc	1.0uF	±10%	CL10B105KQ8NFN □		
		10Vdc	220nF	±10%	CL10B224KP8NFN □	
			330nF	±10%	CL10B334KP8NFN □	
			470nF	±10%	CL10B474KP8NFN □	
			1.0uF	±10%	CL10B105KP8NFN □	
			2.2uF	±10%	CL10B225KP8NFN □	Ref.
	16Vdc	1.5nF	±10%	CL10B152K08NFN □		
		3.3nF	±10%	CL10B332K08NFN □		
		10nF	±10%	CL10B103K08NFN □		
		15nF	±10%	CL10B153K08NFN □		
		33nF	±10%	CL10B333K08NFN □		

Thickness Max.	Rated Voltage	Capacitance	Capacitance Tolerance	Part Number	Remark	
0.90mm	16Vdc	47nF	±10%	CL10B473K08NFN □		
		68nF	±10%	CL10B683K08NFN □		
		100nF	±10%	CL10B104K08NFN □		
		150nF	±10%	CL10B154K08NFN □		
		220nF	±10%	CL10B224K08NFN □		
		330nF	±10%	CL10B334K08NFN □		
		470nF	±10%	CL10B474K08NFN □		
		680nF	±10%	CL10B684K08NFN □		
		1.0uF	±10%	CL10B105K08NFN □		
		25Vdc	1.0nF	±10%	CL10B102KA8NFN □	
			10nF	±10%	CL10B103KA8NFN □	
			12nF	±10%	CL10B123KA8NFN □	
			15nF	±10%	CL10B153KA8NFN □	
			18nF	±10%	CL10B183KA8NFN □	
			22nF	±10%	CL10B223KA8NFN □	
	27nF		±10%	CL10B273KA8NFN □		
	33nF		±10%	CL10B333KA8NFN □		
	47nF		±10%	CL10B473KA8NFN □		
	68nF		±10%	CL10B683KA8NFN □		
	100nF		±10%	CL10B104KA8NFN □		
	150nF		±10%	CL10B154KA8NFN □		
	220nF		±10%	CL10B224KA8NFN □		
	470nF		±10%	CL10B474KA8NFN □		
	1.0uF		±10%	CL10B105KA8NFN □		
	50Vdc	100pF	±10%	CL10B101KB8NFN □		
		150pF	±10%	CL10B151KB8NFN □		
		180pF	±10%	CL10B181KB8NFN □		
		220pF	±10%	CL10B221KB8NFN □		
		270pF	±10%	CL10B271KB8NFN □		
		330pF	±10%	CL10B331KB8NFN □		
		390pF	±10%	CL10B391KB8NFN □		
		470pF	±10%	CL10B471KB8NFN □		
		560pF	±10%	CL10B561KB8NFN □		
		820pF	±10%	CL10B821KB8NFN □		
		1.0nF	±5%	CL10B102JB8NFN □		
		1.0nF	±10%	CL10B102KB8NFN □		
		1.2nF	±10%	CL10B122KB8NFN □		
		1.5nF	±10%	CL10B152KB8NFN □		
		1.8nF	±10%	CL10B182KB8NFN □		
	2.2nF	±10%	CL10B222KB8NFN □			
	2.7nF	±10%	CL10B272KB8NFN □			
	3.3nF	±10%	CL10B332KB8NFN □			
3.9nF	±10%	CL10B392KB8NFN □				
4.7nF	±10%	CL10B472KB8NFN □				
5.6nF	±10%	CL10B562KB8NFN □				
6.8nF	±10%	CL10B682KB8NFN □				
8.2nF	±10%	CL10B822KB8NFN □				
10nF	±5%	CL10B103JB8NFN □				
10nF	±10%	CL10B103KB8NFN □				
12nF	±10%	CL10B123KB8NFN □				
15nF	±10%	CL10B153KB8NFN □				
18nF	±10%	CL10B183KB8NFN □				
22nF	±10%	CL10B223KB8NFN □				
27nF	±10%	CL10B273KB8NFN □				

※ □ mark means packaging code. If you want to learn the code or quantity in detail, please see p.148
In order to move to the page directly, please click the here. ↑

Product Line Up (X7R)

■ Size : 1.60 X 0.80mm (inch : 0603)

Thickness Max.	Rated Voltage	Capacitance	Capacitance Tolerance	Part Number	Remark
0.90mm	50Vdc	33nF	±10%	CL10B333KB8NFN□	
		39nF	±10%	CL10B393KB8NFN□	
		47nF	±10%	CL10B473KB8NFN□	
		56nF	±10%	CL10B563KB8NFN□	
		68nF	±10%	CL10B683KB8NFN□	
		82nF	±10%	CL10B823KB8NFN□	
		100nF	±10%	CL10B104KB8NFN□	
		100nF	±20%	CL10B104MB8NFN□	

■ Size : 2.00 X 1.25mm (inch : 0805)

Thickness Max.	Rated Voltage	Capacitance	Capacitance Tolerance	Part Number	Remark
0.75mm	25Vdc	1.0nF	±10%	CL21B102KAANFN□	
		10nF	±10%	CL21B103KAANFN□	
	50Vdc	100pF	±10%	CL21B101KBANFN□	
		180pF	±10%	CL21B181KBANFN□	
		220pF	±10%	CL21B221KBANFN□	
		270pF	±10%	CL21B271KBANFN□	
		330pF	±10%	CL21B331KBANFN□	
		390pF	±10%	CL21B391KBANFN□	
		470pF	±10%	CL21B471KBANFN□	
		560pF	±10%	CL21B561KBANFN□	
		680pF	±10%	CL21B681KBANFN□	
		820pF	±10%	CL21B821KBANFN□	
		1.0nF	±5%	CL21B102JBANFN□	
		1.0nF	±10%	CL21B102KBANFN□	
		1.2nF	±10%	CL21B122KBANFN□	
		1.5nF	±10%	CL21B152KBANFN□	
		1.8nF	±10%	CL21B182KBANFN□	
		2.2nF	±10%	CL21B222KBANFN□	
		3.3nF	±10%	CL21B332KBANFN□	
		3.9nF	±10%	CL21B392KBANFN□	
		4.7nF	±10%	CL21B472KBANFN□	
		5.6nF	±10%	CL21B562KBANFN□	
		6.8nF	±10%	CL21B682KBANFN□	
		8.2nF	±10%	CL21B822KBANFN□	
		10nF	±10%	CL21B103KBANFN□	
		12nF	±10%	CL21B123KBANFN□	
		15nF	±10%	CL21B153KBANFN□	
		18nF	±10%	CL21B183KBANFN□	
		22nF	±10%	CL21B223KBANFN□	
		27nF	±10%	CL21B273KBANFN□	
	33nF	±10%	CL21B333KBANFN□		
	100Vdc	1.0nF	±10%	CL21B102KCANFN□	
		2.2nF	±10%	CL21B222KCANFN□	
		4.7nF	±10%	CL21B472KCANFN□	
		6.8nF	±10%	CL21B682KCANFN□	
	10nF	10nF	±10%	CL21B103KCANFN□	
		2.2nF	±10%	CL21B224KOCANFN□	
		330nF	±10%	CL21B334KOCANFN□	
		100nF	±10%	CL21B104KACANFN□	
	16Vdc	220nF	±10%	CL21B224KOCANFN□	
		330nF	±10%	CL21B334KOCANFN□	
		100nF	±10%	CL21B104KACANFN□	
		150pF	±10%	CL21B151KBCNFN□	
	50Vdc	180pF	±10%	CL21B181KBCNFN□	

Thickness Max.	Rated Voltage	Capacitance	Capacitance Tolerance	Part Number	Remark		
0.95mm	50Vdc	220pF	±10%	CL21B221KBCNFN□			
		270pF	±10%	CL21B271KBCNFN□			
		330pF	±10%	CL21B331KBCNFN□			
		390pF	±10%	CL21B391KBCNFN□			
		470pF	±10%	CL21B471KBCNFN□			
		560pF	±10%	CL21B561KBCNFN□			
		820pF	±10%	CL21B821KBCNFN□			
		1.0nF	±10%	CL21B102KBCNFN□			
		1.5nF	±10%	CL21B152KBCNFN□			
		2.2nF	±10%	CL21B222KBCNFN□			
		2.7nF	±10%	CL21B272KBCNFN□			
		3.3nF	±10%	CL21B332KBCNFN□			
		4.7nF	±10%	CL21B472KBCNFN□			
		6.8nF	±10%	CL21B682KBCNFN□			
		8.2nF	±10%	CL21B822KBCNFN□			
		10nF	±10%	CL21B103KBCNFN□			
		12nF	±10%	CL21B123KBCNFN□			
		15nF	±10%	CL21B153KBCNFN□			
		18nF	±10%	CL21B183KBCNFN□			
		20nF	±10%	CL21B203KBCNFN□			
		22nF	±10%	CL21B223KBCNFN□			
		27nF	±10%	CL21B273KBCNFN□			
		33nF	±10%	CL21B333KBCNFN□			
		47nF	±5%	CL21B473JBCNFN□			
		47nF	±10%	CL21B473KBCNFN□			
		56nF	±10%	CL21B563KBCNFN□			
		68nF	±10%	CL21B683KBCNFN□			
		82nF	±10%	CL21B823KBCNFN□			
		100nF	±10%	CL21B104KBCNFN□			
		200Vdc	220pF	±10%	CL21B221KDCNFN□		
			470pF	±10%	CL21B471KDCNFN□		
			1.0nF	±10%	CL21B102KDCNFN□		
	2.2nF		±10%	CL21B222KDCNFN□			
	4.7nF		±10%	CL21B472KDCNFN□			
	1.35mm		10Vdc	2.2uF	±10%	CL21B225KPFNFN□	
				4.7uF	±10%	CL21B475KPFNFN□	Ref.
			16Vdc	470nF	±10%	CL21B474KOFNFN□	
				680nF	±10%	CL21B684KOFNFN□	
				1.0uF	±10%	CL21B105KOFNFN□	
				2.2uF	±10%	CL21B225KOFNFN□	
			25Vdc	4.7uF	±10%	CL21B475KOFNFN□	Ref.
				150nF	±10%	CL21B154KAFNFN□	
				220nF	±10%	CL21B224KAFNFN□	
				470nF	±10%	CL21B474KAFNFN□	
			50Vdc	1.0uF	±10%	CL21B105KAFNFN□	
		1.5uF		±10%	CL21B155KAFNFN□		
		2.2uF		±10%	CL21B225KAFNFN□		
		4.7uF		±10%	CL21B475KAFNFN□	Ref.	
120nF		±10%		CL21B124KBFNFN□			
150nF		±10%		CL21B154KBFNFN□			
220nF	±10%	CL21B224KBFNFN□					
330nF	±10%	CL21B334KBFNFN□					
50Vdc	470nF	±10%	CL21B474KBFNFN□				
	1.0uF	±10%	CL21B105KBFNFN□				

* □ mark means packaging code. If you want to learn the code or quantity in detail, please see p.148

In order to move to the page directly, please click the here. ↑

Product Line Up (X7R)

■ Size : 2.00 X 1.25mm (inch : 0805)

Thickness Max.	Rated Voltage	Capacitance	Capacitance Tolerance	Part Number	Remark
1.35mm	100Vdc	220nF	±10%	CL21B224KCFNFN □	
1.40mm	6.3Vdc	4.7uF	±10%	CL21B475KQCNFN □	Ref.
		10uF	±10%	CL21B106KQCNFN □	
	10Vdc	10uF	±10%	CL21B106KPCNFN □	
		16Vdc	10uF	±10%	CL21B106KQCNFN □

■ Size : 3.20 X 1.60mm (inch : 1206)

Thickness Max.	Rated Voltage	Capacitance	Capacitance Tolerance	Part Number	Remark	
1.00mm	10Vdc	1.2uF	±10%	CL31B125KPCNFN □		
	16Vdc	330nF	±10%	CL31B334KOCNFN □		
	25Vdc	220nF	±10%	CL31B224KACNFN □		
	50Vdc	220pF	±10%	CL31B221KBCNFN □		
		330pF	±10%	CL31B331KBCNFN □		
		470pF	±10%	CL31B471KBCNFN □		
		560pF	±10%	CL31B561KBCNFN □		
		680pF	±10%	CL31B681KBCNFN □		
		1.5nF	±10%	CL31B152KBCNFN □		
		2.2nF	±10%	CL31B222KBCNFN □		
		2.7nF	±10%	CL31B272KBCNFN □		
		3.3nF	±10%	CL31B332KBCNFN □		
		4.7nF	±10%	CL31B472KBCNFN □		
		8.2nF	±10%	CL31B822KBCNFN □		
		10nF	±10%	CL31B103KBCNFN □		
		15nF	±10%	CL31B153KBCNFN □		
		33nF	±10%	CL31B333KBCNFN □		
	47nF	±10%	CL31B473KBCNFN □			
	100Vdc	68nF	±10%	CL31B683KBCNFN □		
		100nF	±10%	CL31B104KBCNFN □		
		1.0nF	±10%	CL31B102KCCNFN □		
		2.2nF	±10%	CL31B222KCCNFN □		
		3.3nF	±10%	CL31B332KCCNFN □		
		10nF	±10%	CL31B103KCCNFN □		
	200Vdc	22nF	±10%	CL31B223KCCNFN □		
		470pF	±10%	CL31B471KDCNFN □		
		1.0nF	±10%	CL31B102KDCNFN □		
		1.0uF	±10%	CL31B105KOFNFN □		
	1.40mm	50Vdc	220nF	±10%	CL31B224KBFNFN □	
			330nF	±10%	CL31B334KBFNFN □	
	500Vdc	100Vdc	100nF	±10%	CL31B104KCFNFN □	
		220pF	±10%	CL31B221KGFNFN □		
470pF			±10%	CL31B471KGFNFN □		
1.0nF			±10%	CL31B102KGFNFN □		
2.2nF			±10%	CL31B222KGFNFN □		
3.3nF			±10%	CL31B332KGFNFN □		
4.7nF			±10%	CL31B472KGFNFN □		
6.8nF			±10%	CL31B682KGFNFN □		
10nF			±10%	CL31B103KGFNFN □		
630Vdc		330pF	±10%	CL31B331KHFNFN □		
		470pF	±10%	CL31B471KHFNFN □		
		680pF	±10%	CL31B681KHFNFN □		
		1.0nF	±10%	CL31B102KHFNFN □		
		1.5nF	±10%	CL31B152KHFNFN □		

Thickness Max.	Rated Voltage	Capacitance	Capacitance Tolerance	Part Number	Remark		
1.40mm	630Vdc	2.2nF	±10%	CL31B222KHFNFN □			
		3.3nF	±10%	CL31B332KHFNFN □			
		4.7nF	±10%	CL31B472KHFNFN □			
		6.8nF	±10%	CL31B682KHFNFN □			
		10nF	±10%	CL31B103KHFNFN □			
		220pF	±10%	CL31B221KIFNFN □	Derating		
	1kVdc	1.0nF	±10%	CL31B102KIFNFN □	Derating		
		1.5nF	±10%	CL31B152KIFNFN □	Derating		
		1.80mm	6.3Vdc	6.8uF	±10%	CL31B685KQHNFN □	
				10uF	±10%	CL31B106KQHNFN □	
10Vdc	4.7uF	±10%	CL31B475KPHNFN □				
	22uF	±10%	CL31B226KPHNFN □				
16Vdc	2.2uF	±10%	CL31B225KOHNFN □				
	3.3uF	±10%	CL31B335KOHNFN □				
	4.7uF	±10%	CL31B475KOHNFN □				
	10uF	±10%	CL31B106KOHNFN □				
	25Vdc	680nF	±10%	CL31B684KAHNFN □			
		1.0uF	±10%	CL31B105KAHNFN □			
2.2uF		±10%	CL31B225KAHNFN □				
4.7uF		±10%	CL31B475KAHNFN □				
10uF		±10%	CL31B106KAHNFN □				
10uF		±10%	CL31B106KLHNFN □	Ref.			
35Vdc	470nF	±10%	CL31B474KBHNFN □				
	680nF	±10%	CL31B684KBHNFN □				
	1.0uF	±10%	CL31B105KBHNFN □				
	2.2uF	±10%	CL31B225KBHNFN □				
50Vdc	4.7uF	±10%	CL31B475KBHNFN □				
	220nF	±10%	CL31B224KCHNFN □				
	1.0uF	±10%	CL31B105KCHNFN □				
	100Vdc	100nF	±10%	CL31B104KDHNFN □			
200Vdc	100nF	±10%	CL31B104KEHNFN □				
250Vdc	100nF	±10%	CL31B104KEHNFN □				
500Vdc	33nF	±10%	CL31B333KGHNFN □				
	630Vdc	22nF	±10%	CL31B223KHFNFN □			
2kVdc	33nF	±10%	CL31B333KHFNFN □				
	2.2nF	±10%	CL31B222KJHFNFN □	Ref.			

■ Size : 3.20 X 2.50mm (inch : 1210)

Thickness Max.	Rated Voltage	Capacitance	Capacitance Tolerance	Part Number	Remark
2.20mm	10Vdc	10uF	±10%	CL32B106KPINFN □	
2.70mm	6.3Vdc	22uF	±20%	CL32B226MQJNFN □	
		470nF	±10%	CL32B474KPJNFN □	
		22uF	±10%	CL32B226KPJNFN □	
	10Vdc	22uF	±20%	CL32B226MPJNFN □	
		10uF	±10%	CL32B106KOJNFN □	
		22uF	±10%	CL32B226KOJNFN □	
	16Vdc	10uF	±10%	CL32B106KAJNFN □	
		22uF	±10%	CL32B226KAJNFN □	
		22uF	±10%	CL32B226KBJNFN □	
	25Vdc	10uF	±10%	CL32B106KAJNFN □	
		22uF	±10%	CL32B226KAJNFN □	
		4.7uF	±10%	CL32B475KBJNFN □	
	50Vdc	10uF	±10%	CL32B106KBJNFN □	
		1.0uF	±10%	CL32B105KJNFN □	
100Vdc	1.0uF	±10%	CL32B105KJNFN □		

※ □ mark means packaging code. If you want to learn the code or quantity in detail, please see p.148

In order to move to the page directly, please click the here. ↑

Soft – Termination Capacitors for Power Application

ZFN / SFN / YFN – X7R

Feature



- Soft – Termination relaxes the applied thermal / mechanical stresses by ductile properties of metal-polymer composites.
- Special outgoing inspection for Power application (Bending Test : Sampling Test upto 2mm : X7R)
- Can be applied to power(SMPS, DC – DC Converter) and industrial equipment
- ZFN, SFN, YFN series : Metal Epoxy

Application

- Power(SMPS, DC – DC converter)
- Ideal for decoupling and filtering applications (Class II : X7R)

Structure and Dimensions

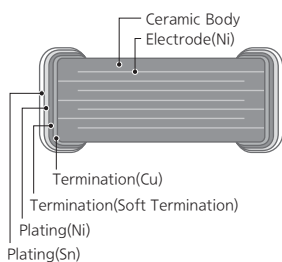
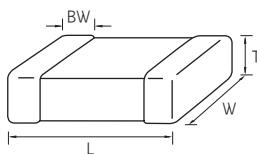

Size Code	EIA Code	Dimension(mm)				
		L	W	T	Thickness Code	BW
10	0603	1.60±0.10	0.80±0.10	0.80±0.10	8	0.30±0.20
21	0805	2.00±0.10	1.25±0.10	0.65±0.10	A	0.50+0.20/-0.30
		2.00±0.10	1.25±0.10	0.85±0.10	C	
		2.00±0.10	1.25±0.10	1.15±0.10	M	
		2.00±0.10	1.25±0.10	1.25±0.10	F	
31	1206	3.20±0.15	1.60±0.15	0.85±0.15	C	0.50±0.30
		3.20±0.15	1.60±0.15	1.25±0.15	F	
		3.20±0.20	1.60±0.20	1.60±0.20	H	

Industrial Capacitance Table (X7R)

Size inch (mm)	Rated Voltage (Vdc)	Capacitance																	
		nF												uF					
		1.0	1.5	2.2	3.3	4.7	10	22	33	47	68	100	220	470	1.0	2.2	4.7	10	22
0402(1005)	50																		
0603 (1608)	10																		
	16																		
	25																		
	50	0.47																	
0805 (2012)	10																		
	16																		
	25																		
1206 (3216)	16																		
	50																		

Product Line Up (ZFN – X7R)

■ Size : 1.60 X 0.80mm (inch : 0603)

Thickness Max.	Rated Voltage	Capacitance	Capacitance Tolerance	Part Number	Remark
0.90mm	10Vdc	2.2uF	±10%	CL10B225KP8ZFN □	Ref.
	16Vdc	1.0uF	±10%	CL10B105K08ZFN □	

■ Size : 2.00 X 1.25mm (inch : 0805)

Thickness Max.	Rated Voltage	Capacitance	Capacitance Tolerance	Part Number	Remark
1.35mm	16Vdc	4.7uF	±10%	CL21B475K0FZFN □	Ref.
	25Vdc	4.7uF	±10%	CL21B475KAFZFN □	Ref.
	50Vdc	1.0uF	±10%	CL21B105KBZFN □	
1.40mm	10Vdc	10uF	±10%	CL21B106KPQZFN □	

■ Size : 3.20 X 1.60mm (inch : 1206)

Thickness Max.	Rated Voltage	Capacitance	Capacitance Tolerance	Part Number	Remark
1.80mm	16Vdc	10uF	±10%	CL31B106K0HZFN □	
	50Vdc	4.7uF	±10%	CL31B475KBHZFN □	

Product Line Up (SFN – X7R)

■ Size : 1.00 X 0.50mm (inch : 0402)

Thickness Max.	Rated Voltage	Capacitance	Capacitance Tolerance	Part Number	Remark
0.55mm	50Vdc	22nF	±10%	CL05B223KB5SFN □	

■ Size : 1.60 X 0.80mm (inch : 0603)

Thickness Max.	Rated Voltage	Capacitance	Capacitance Tolerance	Part Number	Remark	
0.90mm	16Vdc	68nF	±10%	CL10B683K08SFN □		
		100nF	±10%	CL10B104K08SFN □		
		220nF	±10%	CL10B224K08SFN □		
	25Vdc	1.0uF	±10%	CL10B105K08SFN □		
		10nF	±10%	CL10B103KA8SFN □		
		150nF	±10%	CL10B154KA8SFN □		
		220nF	±10%	CL10B224KA8SFN □		
		1.0uF	±10%	CL10B105KA8SFN □		
		50Vdc	470pF	±10%	CL10B471KB8SFN □	
			1.0nF	±10%	CL10B102KB8SFN □	
			1.5nF	±10%	CL10B152KB8SFN □	
			2.2nF	±10%	CL10B222KB8SFN □	
			2.7nF	±10%	CL10B272KB8SFN □	
			3.3nF	±10%	CL10B332KB8SFN □	
			3.9nF	±10%	CL10B392KB8SFN □	
	4.7nF		±10%	CL10B472KB8SFN □		
	5.6nF		±10%	CL10B562KB8SFN □		
	6.8nF		±10%	CL10B682KB8SFN □		
	8.2nF		±10%	CL10B822KB8SFN □		
	10nF		±10%	CL10B103KB8SFN □		
	12nF		±10%	CL10B123KB8SFN □		
	15nF		±10%	CL10B153KB8SFN □		
	22nF		±10%	CL10B223KB8SFN □		
	27nF		±10%	CL10B273KB8SFN □		
	33nF		±10%	CL10B333KB8SFN □		
	39nF		±10%	CL10B393KB8SFN □		
	47nF	±10%	CL10B473KB8SFN □			
	56nF	±10%	CL10B563KB8SFN □			
	100nF	±10%	CL10B104KB8SFN □			
	220nF	±10%	CL10B224KB8SFN □			

※ □ mark means packaging code. If you want to learn the code or quantity in detail, please see p.148
In order to move to the page directly, please click the here. ↑

Soft – Termination Capacitors for Power Application

ZFN / SFN / YFN – X7R

Product Line Up (SFN – X7R)

■ Size : 2.00 X 1.25mm (inch : 0805)

Thickness Max.	Rated Voltage	Capacitance	Capacitance Tolerance	Part Number	Remark
0.70mm	50Vdc	330pF	±10%	CL21B331KB6SFN□	
		470pF	±5%	CL21B471JB6SFN□	
		560pF	±10%	CL21B561KB6SFN□	
		680pF	±10%	CL21B681KB6SFN□	
		2.2nF	±10%	CL21B222KB6SFN□	
		3.3nF	±10%	CL21B332KB6SFN□	
		4.7nF	±10%	CL21B472KB6SFN□	
		6.8nF	±10%	CL21B682KB6SFN□	
		8.2nF	±10%	CL21B822KB6SFN□	
		10nF	±10%	CL21B103KB6SFN□	
		15nF	±10%	CL21B153KB6SFN□	
		22nF	±10%	CL21B223KB6SFN□	
		0.95mm	50Vdc	4.7nF	±10%
10nF	±10%			CL21B103KBCSFN□	
22nF	±10%			CL21B223KBCSFN□	
39nF	±10%			CL21B393KBCSFN□	
47nF	±10%			CL21B473KBCSFN□	
100nF	±10%			CL21B104KBCSFN□	
250Vdc	1.0nF			±10%	CL21B102KECSFN□
		2.2nF	±10%	CL21B222KECSFN□	
1.35mm	16Vdc	1.0uF	±10%	CL21B105KOFSFN□	
	25Vdc	220nF	±10%	CL21B224KAFSFN□	
		470nF	±10%	CL21B474KAFSFN□	
		1.0uF	±10%	CL21B105KAFSFN□	
		2.2uF	±10%	CL21B225KAFSFN□	
	50Vdc	220nF	±10%	CL21B224KBFSFN□	
		470nF	±10%	CL21B474KBFSFN□	
		1.0uF	±10%	CL21B105KBFSFN□	
	100Vdc	100nF	±10%	CL21B104KCFSFN□	
		220nF	±10%	CL21B224KCFSFN□	
1.40mm	16Vdc	4.7uF	±10%	CL21B475KQOSFN□	

■ Size : 3.20 X 1.60mm (inch : 1206)

Thickness Max.	Rated Voltage	Capacitance	Capacitance Tolerance	Part Number	Remark
1.00mm	50Vdc	100nF	±10%	CL31B104KBCSFN□	
1.25mm	16Vdc	470nF	±10%	CL31B474KOPSFN□	
	50Vdc	1.0uF	±10%	CL31B105KBPSFN□	
1.40mm	630Vdc	220pF	±10%	CL31B221KHFSFN□	
		1.0nF	±10%	CL31B102KHFSFN□	
		1.5nF	±10%	CL31B152KHFSFN□	
		2.2nF	±10%	CL31B222KHFSFN□	
		2.7nF	±10%	CL31B272KHFSFN□	
		3.3nF	±10%	CL31B332KHFSFN□	
		4.7nF	±10%	CL31B472KHFSFN□	
		6.8nF	±10%	CL31B682KHFSFN□	
		10nF	±10%	CL31B103KHFSFN□	
		15nF	±10%	CL31B153KHFSFN□	
	1kVdc	1.0nF	±10%	CL31B102KIFSFN□	Operating
1.80mm	25Vdc	10uF	±10%	CL31B106KAHSFN□	
	35Vdc	10uF	±10%	CL31B106KLHSFN□	Ref.

Thickness Max.	Rated Voltage	Capacitance	Capacitance Tolerance	Part Number	Remark
1.80mm	100Vdc	220nF	±10%	CL31B224KCHSFN□	
		470nF	±10%	CL31B474KCHSFN□	
		1.0uF	±10%	CL31B105KCHSFN□	
		2.2uF	±10%	CL31B225KCHSFN□	
		250Vdc	47nF	±10%	CL31B473KEHSFN□
	630Vdc	100nF	±10%	CL31B104KEHSFN□	
		22nF	±10%	CL31B223KHHSFN□	
		33nF	±10%	CL31B333KHHSFN□	

■ Size : 3.20 X 2.50mm (inch : 1210)

Thickness Max.	Rated Voltage	Capacitance	Capacitance Tolerance	Part Number	Remark
2.70mm	50Vdc	2.2uF	±10%	CL32B225KBJSFN□	
	100Vdc	1.0uF	±10%	CL32B105KCJSFN□	
		2.2uF	±10%	CL32B225KCJSFN□	

Product Line Up (YFN – X7R)

■ Size : 3.20 X 2.50mm (inch : 1210)

Thickness Max.	Rated Voltage	Capacitance	Capacitance Tolerance	Part Number	Remark
2.00mm	25Vdc	4.7uF	±10%	CL32B475KAUYFN□	
	50Vdc	4.7uF	±10%	CL32B475KBUYFN□	

※ □ mark means packaging code. If you want to learn the code or quantity in detail, please see p.148

In order to move to the page directly, please click the here. †

Soft - Termination(3mm) Industrial Capacitors

ZW6 / SW6 - X7R / X7S

Feature



- Excellent bending strength($\geq 3\text{mm}$) & 40°C 95%RH 500hr with rated voltage
- Soft - Termination is applicable to all class II MLCC series
- W6 = Industrial(3mm bending) code for Network, Power, etc
- Special outgoing inspection for industrial application (HALT, etc)
- Bending strength simulation

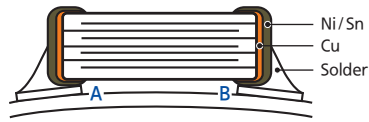

Cross-section of MLCC with Cu - Termination

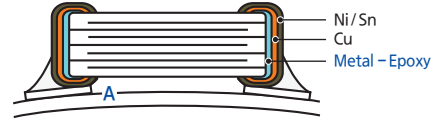

Cross-section of MLCC with Soft - Termination

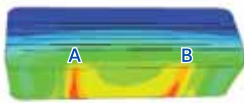

Soft - Termination relaxes the applied thermal - mechanical stresses by ductile properties of metal - polymer composites.

- Comparison of bending strength

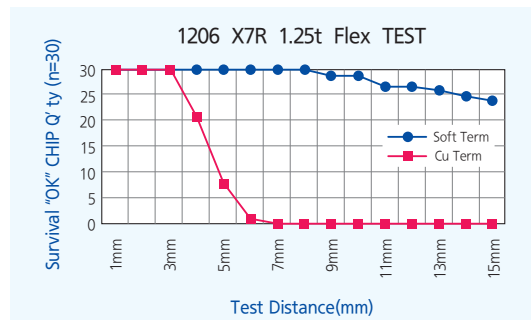

Application

- Network, Power application and etc.
- Ideal for decoupling and filtering applications (Class II : X7R)

Structure and Dimensions

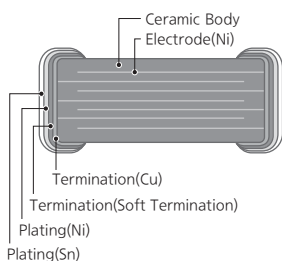
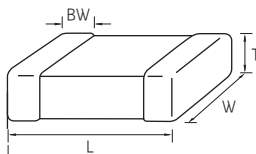

Size Code	EIA Code	Dimension(mm)				
		L	W	T	Thickness Code	BW
05	0402	1.00 ± 0.05	0.50 ± 0.05	0.50 ± 0.05	5	0.25 ± 0.10
10	0603	1.60 ± 0.10	0.80 ± 0.10	0.80 ± 0.10	8	0.30 ± 0.20
21	0805	2.00 ± 0.10	1.25 ± 0.10	0.85 ± 0.10	C	$0.50 + 0.20 / - 0.30$
		2.00 ± 0.10	1.25 ± 0.10	1.25 ± 0.10	F	
		2.00 ± 0.15	1.25 ± 0.15	1.25 ± 0.15	Q	
31	1206	3.20 ± 0.20	1.60 ± 0.20	1.15 ± 0.10	P	0.50 ± 0.30
		3.20 ± 0.15	1.60 ± 0.15	1.25 ± 0.15	F	
		3.20 ± 0.20	1.60 ± 0.20	1.60 ± 0.20	H	
32	1210	3.20 ± 0.30	2.50 ± 0.20	2.50 ± 0.20	J	0.60 ± 0.30
		3.20 ± 0.40	2.50 ± 0.30	2.50 ± 0.30	V	

Soft – Termination(3mm) Industrial Capacitors

ZW6 / SW6 – X7R /X7S

Industrial Capacitance Table (X7R)

Size inch (mm)	Rated Voltage (Vdc)	Capacitance															
		nF									uF						
		1.5	2.2	4.7	10	22	47	100	220	470	1.0	2.2	4.7	10	22	47	100
0402 (1005)	16				█	█	█	█	█								
	25				█	█	█	█	█								
	50				█	█	█	█	█								
0603 (1608)	16					█	█	█	█	█	█						
	25				█	█	█	█	█	█	█						
	50	█	█	█	█	█	█	█	█	█	█						
	100				█	█	█	█	█								
0805 (2012)	10										█	█	█				
	16										█	█	█				
	25					█	█	█	█	█	█	█					
	50	█	█	█	█	█	█	█	█	█	█	█					
	100				█	█	█	█	█								
1206 (3216)	10													█	█		
	16													█	█		
	25													█	█		
	50							█	█	█	█	█	█				
	100							█	█								
1210 (3225)	10														█	█	
	16														█	█	
	50													█	█		
	100													█	█		

Product Line Up (X7R)

■ Size : 1.60 X 0.80mm (inch : 0603)

Thickness Max.	Rated Voltage	Capacitance	Capacitance Tolerance	Part Number	Remark
0.90mm	16Vdc	1.0uF	±10%	CL10B105K08ZW6□	
	25Vdc	1.0uF	±10%	CL10B105KA8ZW6□	
	50Vdc	100nF	±10%	CL10B104KB8ZW6□	

■ Size : 2.00 X 1.25mm (inch : 0805)

Thickness Max.	Rated Voltage	Capacitance	Capacitance Tolerance	Part Number	Remark
0.95mm	100Vdc	47nF	±10%	CL21B473KCCZW6□	
		100nF	±10%	CL21B104KCCZW6□	
1.35mm	25Vdc	1.0uF	±10%	CL21B105KAFZW6□	
		2.2uF	±10%	CL21B225KAFZW6□	
		4.7uF	±10%	CL21B475KAFZW6□	Ref.
	50Vdc	1.0uF	±10%	CL21B105KBFZW6□	
1.40mm	16Vdc	4.7uF	±10%	CL21B475KQZW6□	Ref.

■ Size: 3.20 X 1.60mm (inch : 1206)

Thickness Max.	Rated Voltage	Capacitance	Capacitance Tolerance	Part Number	Remark
1.25mm	100Vdc	100nF	±10%	CL31B104KCPZW6□	
1.40mm	100Vdc	100nF	±10%	CL31B104KCFZW6□	
1.80mm	16Vdc	10uF	±10%	CL31B106KOHZW6□	
		4.7uF	±10%	CL31B475KAHZW6□	
	25Vdc	10uF	±10%	CL31B106KAHZW6□	
		4.7uF	±10%	CL31B475KBHZW6□	

■ Size: 3.20 X 2.50mm (inch : 1210)

Thickness Max.	Rated Voltage	Capacitance	Capacitance Tolerance	Part Number	Remark
2.70mm	50Vdc	10uF	±10%	CL32B106KBJZW6□	
	100Vdc	2.2uF	±10%	CL32B225KCJZW6□	
2.80mm	100Vdc	4.7uF	±10%	CL32B475KCVZW6□	Derating

Product Line Up (X7S)

■ Size : 1.60 X 0.80mm (inch : 0603)

Thickness Max.	Rated Voltage	Capacitance	Capacitance Tolerance	Part Number	Remark
0.90mm	50Vdc	100uF	±10%	CL10Y104KB8ZW6□	

※ □ mark means packaging code. If you want to learn the code or quantity in detail, please see p.148
In order to move to the page directly, please click the here. ↑

Reinforced Soft – Termination(3mm) Industrial Capacitors

Feature



- Excellent bending strength($\geq 3\text{mm}$) & 85°C 85%RH 1000hr with rated voltage
- Soft-Termination is applicable to all class II MLCC series
- Durability against thermal shock / cycles

Application

- Network, Power application and etc.
- Ideal for decoupling and filtering applications (Class II : X7R)

Structure and Dimensions

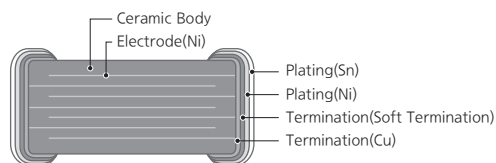
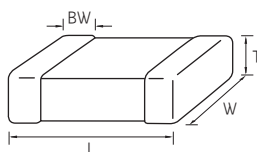

Size Code	EIA Code	Dimension(mm)				
		L	W	T	Thickness Code	BW
05	0402	1.00 ± 0.05	0.50 ± 0.05	0.50 ± 0.05	5	0.25 ± 0.10
10	0603	1.60 ± 0.10	0.80 ± 0.10	0.80 ± 0.10	8	0.30 ± 0.20
21	0805	2.00 ± 0.10	1.25 ± 0.10	0.60 ± 0.10	6	$0.50 + 0.20 / -0.30$
		2.00 ± 0.10	1.25 ± 0.10	0.85 ± 0.10	C	
		2.00 ± 0.10	1.25 ± 0.10	1.25 ± 0.10	F	
		2.00 ± 0.15	1.25 ± 0.15	1.25 ± 0.15	Q	
31	1206	3.20 ± 0.20	1.60 ± 0.20	1.15 ± 0.10	P	0.50 ± 0.30
		3.20 ± 0.20	1.60 ± 0.20	1.60 ± 0.20	H	
32	1210	3.20 ± 0.30	2.50 ± 0.20	2.50 ± 0.20	J	0.60 ± 0.30

Industrial Capacitance Table (X7R)

Size inch (mm)	Rated Voltage (Vdc)	Capacitance														
		nF							uF							
		10	22	47	100	220	470	1.0	2.2	4.7	10	22	47	100		
0402 (1005)	16	████████████████████														
	25	██████████														
	50	██████████														
0603 (1608)	16			████████████████████												
	25	████████████████████														
	50	████████████████														
	100	██████████														
0805 (2012)	10							████████████████								
	16							████████████████								
	25			████████████████												
	50	████████████████														
	100	██████████														
1206 (3216)	10										████████					
	16							████████████████								
	25							████████████████								
	50			████████████████												
	100			██████████												
1210 (3225)	10											████████				
	16											████████				
	50									████████						

Industrial Capacitors

Reinforced Soft – Termination(3mm) Industrial Capacitors

Z46 – X7R

Product Line Up (X7R)

■ Size : 1.00 X 0.50mm (inch : 0402)

Thickness Max.	Rated Voltage	Capacitance	Capacitance Tolerance	Part Number
0.55mm	16Vdc	15nF	±10%	CL05B153K05Z46□
		22nF	±10%	CL05B223K05Z46□
		33nF	±10%	CL05B333K05Z46□
		47nF	±10%	CL05B473K05Z46□
		100nF	±10%	CL05B104K05Z46□
	25Vdc	1.0nF	±10%	CL05B102KA5Z46□
		4.7nF	±10%	CL05B472KA5Z46□
		10nF	±10%	CL05B103KA5Z46□
	50Vdc	22nF	±10%	CL05B223KA5Z46□
		330pF	±10%	CL05B331KB5Z46□
		470pF	±10%	CL05B471KB5Z46□
		1.0nF	±10%	CL05B102KB5Z46□
		1.5nF	±10%	CL05B152KB5Z46□
		2.2nF	±10%	CL05B222KB5Z46□
		4.7nF	±10%	CL05B472KB5Z46□
		10nF	±10%	CL05B103KB5Z46□
	15nF	±10%	CL05B153KB5Z46□	
	22nF	±10%	CL05B223KB5Z46□	

■ Size : 1.60 X 0.80mm (inch : 0603)

Thickness Max.	Rated Voltage	Capacitance	Capacitance Tolerance	Part Number
0.90mm	10Vdc	1.0uF	±10%	CL10B105KP8Z46□
		16Vdc	47nF	±10%
	25Vdc	68nF	±10%	CL10B683K08Z46□
		100nF	±10%	CL10B104K08Z46□
		220nF	±10%	CL10B224K08Z46□
		470nF	±10%	CL10B474K08Z46□
		680nF	±10%	CL10B684K08Z46□
		1.0uF	±10%	CL10B105K08Z46□
		10nF	±10%	CL10B103KA8Z46□
		68nF	±10%	CL10B683KA8Z46□
		100nF	±10%	CL10B104KA8Z46□
		150nF	±10%	CL10B154KA8Z46□
	50Vdc	220nF	±10%	CL10B224KA8Z46□
		470nF	±10%	CL10B474KA8Z46□
		1.0uF	±10%	CL10B105KA8Z46□
		220pF	±10%	CL10B221KB8Z46□
		470pF	±10%	CL10B471KB8Z46□
		1.0nF	±10%	CL10B102KB8Z46□
		1.2nF	±10%	CL10B122KB8Z46□
		1.5nF	±10%	CL10B152KB8Z46□
		2.2nF	±10%	CL10B222KB8Z46□
		3.3nF	±10%	CL10B332KB8Z46□
		4.7nF	±10%	CL10B472KB8Z46□
		6.8nF	±10%	CL10B682KB8Z46□
		10nF	±10%	CL10B103KB8Z46□
		15nF	±10%	CL10B153KB8Z46□
		22nF	±10%	CL10B223KB8Z46□
		33nF	±10%	CL10B333KB8Z46□
		47nF	±10%	CL10B473KB8Z46□
		68nF	±10%	CL10B683KB8Z46□
	100nF	±10%	CL10B104KB8Z46□	
	100Vdc	150nF	±10%	CL10B154KB8Z46□
		220nF	±10%	CL10B224KB8Z46□
		270pF	±10%	CL10B271KC8Z46□
		470pF	±10%	CL10B471KC8Z46□
		1.0nF	±10%	CL10B102KC8Z46□
		2.2nF	±10%	CL10B222KC8Z46□
		2.7nF	±10%	CL10B272KC8Z46□
		4.7nF	±10%	CL10B472KC8Z46□
	10nF	±10%	CL10B103KC8Z46□	
	68nF	±10%	CL10B683KC8Z46□	

※ □ mark means packaging code. If you want to learn the code or quantity in detail, please see p.148

In order to move to the page directly, please click the here. ↑

Product Line Up (X7R)

■ Size : 2.00 X 1.25mm (inch : 0805)

Thickness Max.	Rated Voltage	Capacitance	Capacitance Tolerance	Part Number	Remark		
0.70mm	50Vdc	1.0nF	±10%	CL21B102KB6Z46 □			
		1.5nF	±10%	CL21B152KB6Z46 □			
		2.2nF	±10%	CL21B222KB6Z46 □			
		4.7nF	±10%	CL21B472KB6Z46 □			
		10nF	±10%	CL21B103KB6Z46 □			
		22nF	±10%	CL21B223KB6Z46 □			
	100Vdc	1.0nF	±10%	CL21B102KC6Z46 □			
		3.3nF	±10%	CL21B332KC6Z46 □			
		4.7nF	±10%	CL21B472KC6Z46 □			
		10nF	±10%	CL21B103KC6Z46 □			
		15nF	±10%	CL21B153KC6Z46 □			
		22nF	±10%	CL21B223KC6Z46 □			
		0.95mm	25Vdc	100nF	±10%	CL21B104KACZ46 □	
				50Vdc	47nF	±10%	CL21B473KBCZ46 □
68nF	±10%			CL21B683KBCZ46 □			
100Vdc	100nF		±10%	CL21B104KBCZ46 □			
	47nF		±10%	CL21B473KCCZ46 □			
	68nF		±10%	CL21B683KCCZ46 □			
1.35mm	16Vdc	100nF	±10%	CL21B104KCCZ46 □			
		470nF	±10%	CL21B474KOFZ46 □			
		1.0uF	±10%	CL21B105KOFZ46 □			
	25Vdc	2.2uF	±10%	CL21B225KOFZ46 □			
		220nF	±10%	CL21B224KAFZ46 □			
		1.0uF	±10%	CL21B105KAFZ46 □			
	35Vdc	2.2uF	±10%	CL21B225KAFZ46 □			
		1.0uF	±10%	CL21B105KLFZ46 □			
	50Vdc	100nF	±10%	CL21B104KBFZ46 □			
		180nF	±10%	CL21B184KBFZ46 □			
		220nF	±10%	CL21B224KBFZ46 □			
		330nF	±10%	CL21B334KBFZ46 □			
		470nF	±10%	CL21B474KBFZ46 □			
		1.0uF	±10%	CL21B105KBFZ46 □			
100Vdc	100nF	±10%	CL21B104KCFZ46 □				
1.40mm	10Vdc	4.7uF	±10%	CL21B475KPQZ46 □	Ref.		
	16Vdc	4.7uF	±10%	CL21B475KOQZ46 □	Ref.		

■ Size : 3.20 X 1.60mm (inch : 1206)

Thickness Max.	Rated Voltage	Capacitance	Capacitance Tolerance	Part Number	Remark
1.25mm	25Vdc	1.0uF	±10%	CL31B105KAPZ46 □	
		50Vdc	100nF	±10%	CL31B104KBPZ46 □
	100Vdc	100nF	±10%	CL31B104KCPZ46 □	
		220nF	±10%	CL31B224KCPZ46 □	
		2.2uF	±10%	CL31B225KOHZ46 □	
1.80mm	16Vdc	10uF	±10%	CL31B106KOHZ46 □	
		2.2uF	±10%	CL31B225KOHZ46 □	
	25Vdc	1.5uF	±10%	CL31B155KAHZ46 □	
		2.2uF	±10%	CL31B225KAHZ46 □	
		3.3uF	±10%	CL31B335KAHZ46 □	
		4.7uF	±10%	CL31B475KAHZ46 □	
		10uF	±10%	CL31B106KAHZ46 □	
		470nF	±10%	CL31B474KBHZ46 □	
	50Vdc	680nF	±10%	CL31B684KBHZ46 □	
		1.0uF	±10%	CL31B105KBHZ46 □	
1.5uF		±10%	CL31B155KBHZ46 □		
2.2uF		±10%	CL31B225KBHZ46 □		
		4.7uF	±10%	CL31B475KBHZ46 □	

■ Size : 3.20 X 2.50mm (inch : 1210)

Thickness Max.	Rated Voltage	Capacitance	Capacitance Tolerance	Part Number	Remark
2.70mm	16Vdc	22uF	±10%	CL32B226KOJZ46 □	
		22uF	±20%	CL32B226MOJZ46 □	
	50Vdc	4.7uF	±10%	CL32B475KBJZ46 □	

※ □ mark means packaging code. If you want to learn the code or quantity in detail, please see p.148
In order to move to the page directly, please click the here. ↑

Reinforced Soft – Termination(5mm) Industrial Capacitors

Z4J – X7R

Feature



- Excellent bending strength($\geq 5\text{mm}$) & 85°C 85%RH 1000hr with rated voltage
- Soft – Termination is applicable to all class II MLCC series
- Durability against thermal shock / cycles

Application

- Network, Power application and etc.
- Ideal for decoupling and filtering applications (Class II : X7R)
(Directly connected to battery)

Structure and Dimensions

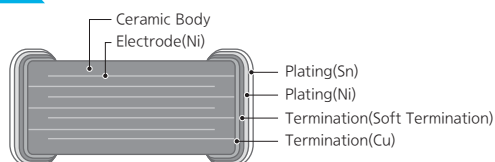
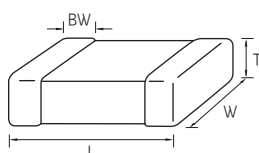

Size Code	EIA Code	Dimension(mm)				
		L	W	T	Thickness Code	BW
10	0603	1.60 ± 0.10	0.80 ± 0.10	0.80 ± 0.10	8	0.30 ± 0.20
21	0805	2.00 ± 0.10	1.25 ± 0.10	1.25 ± 0.10	F	$0.50 + 0.20 / -0.30$

Industrial Capacitance Table (X7R)

Size inch (mm)	Rated Voltage (Vdc)	Capacitance											
		nF									uF		
		1.5	4.7	10	22	47	100	220	470	1.0	2.2	4.7	
0603 (1608)	25												
	50												
0805 (2012)	25												
	50												

Product Line Up (X7R)

■ Size : 1.60 X 0.80mm (inch : 0603)

Thickness Max.	Rated Voltage	Capacitance	Capacitance Tolerance	Part Number
0.90mm	25Vdc	220nF	$\pm 10\%$	CL10B224KA8Z4J □
		1.0uF	$\pm 10\%$	CL10B105KA8Z4J □
	50Vdc	1.5nF	$\pm 10\%$	CL10B152KB8Z4J □
		4.7nF	$\pm 10\%$	CL10B472KB8Z4J □
		22nF	$\pm 10\%$	CL10B223KB8Z4J □
		47nF	$\pm 10\%$	CL10B473KB8Z4J □
		100nF	$\pm 10\%$	CL10B104KB8Z4J □
		220nF	$\pm 10\%$	CL10B224KB8Z4J □
		470nF	$\pm 10\%$	CL10B474KB8Z4J □

■ Size : 2.00 X 1.25mm (inch : 0805)

Thickness Max.	Rated Voltage	Capacitance	Capacitance Tolerance	Part Number
1.35mm	25Vdc	2.2uF	$\pm 10\%$	CL21B225KAFZ4J □
	50Vdc	1.0uF	$\pm 10\%$	CL21B105KBFZ4J □

※ □ mark means packaging code. If you want to learn the code or quantity in detail, please see p.148
In order to move to the page directly, please click the here. ↑

Feature



- High Q and low ESR in high frequency range
- Tight tolerance available
- Expanding High-Q (Cu inner-electrode) line – up of 0402, 0603, 0805 case size (0201, 01005 products are already under mass production)
- High efficiency and low power consumption in RF circuit
- Special outgoing inspection for industrial application (HALT, etc)
- Comparison of Q value in high frequency (Normal vs High-Q)

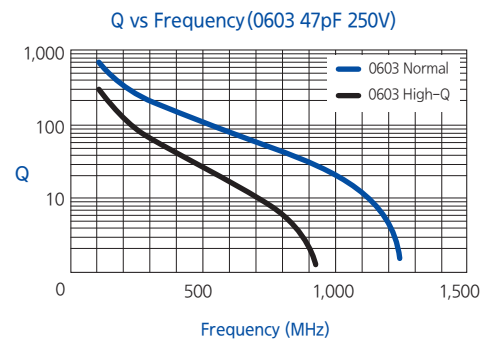
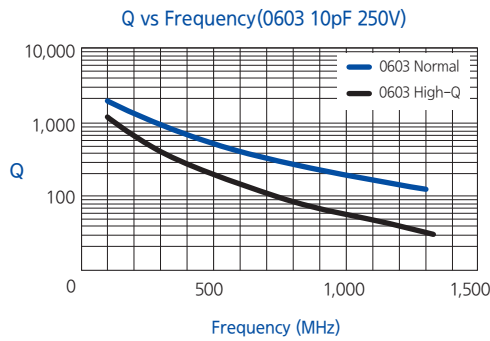

Application

- Power amplifier module for base-station and GHz range communications
- Smart Factory & Smart Home (IoT)

Structure and Dimensions

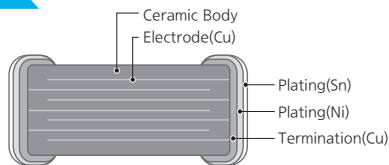
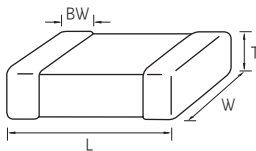

Size Code	EIA Code	Dimension(mm)				
		L	W	T	Thickness Code	BW
03	0201	0.60±0.03	0.30±0.03	0.30±0.03	3	0.15±0.05
05	0402	1.00±0.05	0.50±0.05	0.50±0.05	5	0.25±0.10
10	0603	1.60±0.15	0.80±0.15	0.65±0.15	A	0.30±0.20
21	0805	2.00±0.10	1.25±0.10	0.85±0.10	C	0.50+0.20/-0.30

Industrial Capacitance Table (COG)

Size inch (mm)	T max. (mm)	Rated Voltage (Vdc)	Capacitance(pF)																			
			0.1	0.5	1.0	1.5	2.2	3.3	4.7	6.8	10	15	22	33	47	6.8	100	150	220			
01005 (0402)	0.22	16														27						
		25														27						
0201 (0603)	0.33	25												33								
		50												15								
0402(1005)	0.55	50												47								
0603 (1608)	0.90	50														150						
		100														100						
	0.80	250	0.5													47						
0805(2012)	1.00	250	0.5													100						

Product Line Up (COG)

■ Size: 0.60 X 0.30mm (inch : 0201)

Thickness Max.	Rated Voltage	Capacitance	Capacitance Tolerance	Part Number
0.33mm	25Vdc	4.7pF	±0.25pF	CL03C4R7CA3GNW□
		10pF	±0.5pF	CL03C100DA3GNW□

■ Size : 1.00 X 0.50mm (inch : 0402)

Thickness Max.	Rated Voltage	Capacitance	Capacitance Tolerance	Part Number
0.55mm	50Vdc	0.1pF	±0.05pF	CL05C0R1AB5GNW□
		0.1pF	±0.1pF	CL05C0R1BB5GNW□
		0.2pF	±0.05pF	CL05C0R2AB5GNW□
		0.2pF	±0.1pF	CL05C0R2BB5GNW□
		0.3pF	±0.05pF	CL05C0R3AB5GNW□
		0.3pF	±0.1pF	CL05C0R3BB5GNW□
		0.4pF	±0.05pF	CL05C0R4AB5GNW□
		0.4pF	±0.1pF	CL05C0R4BB5GNW□
		0.5pF	±0.05pF	CL05C0R5AB5GNW□
		0.5pF	±0.1pF	CL05C0R5BB5GNW□
		0.6pF	±0.05pF	CL05C0R6AB5GNW□
		0.6pF	±0.1pF	CL05C0R6BB5GNW□
		0.7pF	±0.05pF	CL05C0R7AB5GNW□
		0.7pF	±0.1pF	CL05C0R7BB5GNW□
		0.8pF	±0.05pF	CL05C0R8AB5GNW□
		0.8pF	±0.1pF	CL05C0R8BB5GNW□
		0.9pF	±0.05pF	CL05C0R9AB5GNW□
		0.9pF	±0.1pF	CL05C0R9BB5GNW□
		1.0pF	±0.05pF	CL05C010AB5GNW□
		1.0pF	±0.1pF	CL05C010BB5GNW□
		1.0pF	±0.25pF	CL05C010CB5GNW□
		1.1pF	±0.05pF	CL05C1R1AB5GNW□
		1.1pF	±0.1pF	CL05C1R1BB5GNW□
		1.1pF	±0.25pF	CL05C1R1CB5GNW□
		1.2pF	±0.05pF	CL05C1R2AB5GNW□
		1.2pF	±0.1pF	CL05C1R2BB5GNW□
		1.2pF	±0.25pF	CL05C1R2CB5GNW□
		1.3pF	±0.05pF	CL05C1R3AB5GNW□
		1.3pF	±0.1pF	CL05C1R3BB5GNW□
		1.3pF	±0.25pF	CL05C1R3CB5GNW□
		1.5pF	±0.05pF	CL05C1R5AB5GNW□
		1.5pF	±0.1pF	CL05C1R5BB5GNW□
		1.5pF	±0.25pF	CL05C1R5CB5GNW□
		1.6pF	±0.05pF	CL05C1R6AB5GNW□
		1.6pF	±0.1pF	CL05C1R6BB5GNW□
		1.6pF	±0.25pF	CL05C1R6CB5GNW□
		1.8pF	±0.05pF	CL05C1R8AB5GNW□
		1.8pF	±0.1pF	CL05C1R8BB5GNW□
		1.8pF	±0.25pF	CL05C1R8CB5GNW□
		2.0pF	±0.05pF	CL05C020AB5GNW□
		2.0pF	±0.1pF	CL05C020BB5GNW□
		2.0pF	±0.25pF	CL05C020CB5GNW□
2.2pF	±0.05pF	CL05C2R2AB5GNW□		
2.2pF	±0.1pF	CL05C2R2BB5GNW□		
2.2pF	±0.25pF	CL05C2R2CB5GNW□		
2.4pF	±0.05pF	CL05C2R4AB5GNW□		
2.4pF	±0.1pF	CL05C2R4BB5GNW□		

Thickness Max.	Rated Voltage	Capacitance	Capacitance Tolerance	Part Number
0.55mm	50Vdc	2.4pF	±0.25pF	CL05C2R4CB5GNW□
		2.7pF	±0.05pF	CL05C2R7AB5GNW□
		2.7pF	±0.1pF	CL05C2R7BB5GNW□
		2.7pF	±0.25pF	CL05C2R7CB5GNW□
		3.0pF	±0.05pF	CL05C030AB5GNW□
		3.0pF	±0.1pF	CL05C030BB5GNW□
		3.0pF	±0.25pF	CL05C030CB5GNW□
		3.3pF	±0.05pF	CL05C3R3AB5GNW□
		3.3pF	±0.1pF	CL05C3R3BB5GNW□
		3.3pF	±0.25pF	CL05C3R3CB5GNW□
		3.6pF	±0.05pF	CL05C3R6AB5GNW□
		3.6pF	±0.1pF	CL05C3R6BB5GNW□
		3.6pF	±0.25pF	CL05C3R6CB5GNW□
		3.9pF	±0.05pF	CL05C3R9AB5GNW□
		3.9pF	±0.1pF	CL05C3R9BB5GNW□
		3.9pF	±0.25pF	CL05C3R9CB5GNW□
		4.0pF	±0.05pF	CL05C040AB5GNW□
		4.0pF	±0.1pF	CL05C040BB5GNW□
		4.0pF	±0.25pF	CL05C040CB5GNW□
		4.3pF	±0.05pF	CL05C4R3AB5GNW□
		4.3pF	±0.1pF	CL05C4R3BB5GNW□
		4.3pF	±0.25pF	CL05C4R3CB5GNW□
		4.7pF	±0.05pF	CL05C4R7AB5GNW□
		4.7pF	±0.1pF	CL05C4R7BB5GNW□
		4.7pF	±0.25pF	CL05C4R7CB5GNW□
		5.0pF	±0.05pF	CL05C050AB5GNW□
		5.0pF	±0.1pF	CL05C050BB5GNW□
		5.0pF	±0.25pF	CL05C050CB5GNW□
		5.1pF	±0.05pF	CL05C5R1AB5GNW□
		5.1pF	±0.1pF	CL05C5R1BB5GNW□
		5.1pF	±0.25pF	CL05C5R1CB5GNW□
		5.1pF	±0.5pF	CL05C5R1DB5GNW□
		5.6pF	±0.05pF	CL05C5R6AB5GNW□
		5.6pF	±0.1pF	CL05C5R6BB5GNW□
		5.6pF	±0.25pF	CL05C5R6CB5GNW□
		5.6pF	±0.5pF	CL05C5R6DB5GNW□
		6.0pF	±0.05pF	CL05C060AB5GNW□
		6.0pF	±0.1pF	CL05C060BB5GNW□
		6.0pF	±0.25pF	CL05C060CB5GNW□
		6.0pF	±0.5pF	CL05C060DB5GNW□
		6.2pF	±0.05pF	CL05C6R2AB5GNW□
		6.2pF	±0.1pF	CL05C6R2BB5GNW□
6.2pF	±0.25pF	CL05C6R2CB5GNW□		
6.2pF	±0.5pF	CL05C6R2DB5GNW□		
6.8pF	±0.05pF	CL05C6R8AB5GNW□		
6.8pF	±0.1pF	CL05C6R8BB5GNW□		
6.8pF	±0.25pF	CL05C6R8CB5GNW□		
6.8pF	±0.5pF	CL05C6R8DB5GNW□		
7.0pF	±0.05pF	CL05C070AB5GNW□		
7.0pF	±0.1pF	CL05C070BB5GNW□		
7.0pF	±0.25pF	CL05C070CB5GNW□		
7.0pF	±0.5pF	CL05C070DB5GNW□		
7.5pF	±0.05pF	CL05C7R5AB5GNW□		
7.5pF	±0.1pF	CL05C7R5BB5GNW□		

※ □ mark means packaging code. If you want to learn the code or quantity in detail, please see p.148

In order to move to the page directly, please click the here. ↑

Product Line Up (COG)

■ Size : 1.00 X 0.50mm (inch : 0402)

Thickness Max.	Rated Voltage	Capacitance	Capacitance Tolerance	Part Number
0.55mm	50Vdc	7.5pF	±0.25pF	CL05C7R5CB5GNW□
		7.5pF	±0.5pF	CL05C7R5DB5GNW□
		8.0pF	±0.05pF	CL05C080AB5GNW□
		8.0pF	±0.1pF	CL05C080BB5GNW□
		8.0pF	±0.25pF	CL05C080CB5GNW□
		8.0pF	±0.5pF	CL05C080DB5GNW□
		8.2pF	±0.05pF	CL05C8R2AB5GNW□
		8.2pF	±0.1pF	CL05C8R2BB5GNW□
		8.2pF	±0.25pF	CL05C8R2CB5GNW□
		8.2pF	±0.5pF	CL05C8R2DB5GNW□
		9.0pF	±0.05pF	CL05C090AB5GNW□
		9.0pF	±0.1pF	CL05C090BB5GNW□
		9.0pF	±0.25pF	CL05C090CB5GNW□
		9.0pF	±0.5pF	CL05C090DB5GNW□
		9.1pF	±0.05pF	CL05C9R1AB5GNW□
		9.1pF	±0.1pF	CL05C9R1BB5GNW□
		9.1pF	±0.25pF	CL05C9R1CB5GNW□
		9.1pF	±0.5pF	CL05C9R1DB5GNW□
		10pF	±1%	CL05C100FB5GNW□
		10pF	±2%	CL05C100GB5GNW□
		10pF	±5%	CL05C100JB5GNW□
		11pF	±1%	CL05C110FB5GNW□
		11pF	±2%	CL05C110GB5GNW□
		11pF	±5%	CL05C110JB5GNW□
		12pF	±1%	CL05C120FB5GNW□
		12pF	±2%	CL05C120GB5GNW□
		12pF	±5%	CL05C120JB5GNW□
		15pF	±1%	CL05C150FB5GNW□
		15pF	±2%	CL05C150GB5GNW□
		15pF	±5%	CL05C150JB5GNW□
		18pF	±1%	CL05C180FB5GNW□
		18pF	±2%	CL05C180GB5GNW□
		18pF	±5%	CL05C180JB5GNW□
		20pF	±1%	CL05C200FB5GNW□
		20pF	±2%	CL05C200GB5GNW□
		20pF	±5%	CL05C200JB5GNW□
		22pF	±1%	CL05C220FB5GNW□
		22pF	±2%	CL05C220GB5GNW□
		22pF	±5%	CL05C220JB5GNW□
		24pF	±1%	CL05C240FB5GNW□
24pF	±2%	CL05C240GB5GNW□		
24pF	±5%	CL05C240JB5GNW□		
27pF	±1%	CL05C270FB5GNW□		
27pF	±2%	CL05C270GB5GNW□		
27pF	±5%	CL05C270JB5GNW□		
33pF	±1%	CL05C330FB5GNW□		
33pF	±2%	CL05C330GB5GNW□		
33pF	±5%	CL05C330JB5GNW□		
39pF	±1%	CL05C390FB5GNW□		
39pF	±2%	CL05C390GB5GNW□		
39pF	±5%	CL05C390JB5GNW□		
47pF	±1%	CL05C470FB5GNW□		
47pF	±2%	CL05C470GB5GNW□		
47pF	±5%	CL05C470JB5GNW□		

■ Size : 1.60 X 0.80mm (inch : 0603)

Thickness Max.	Rated Voltage	Capacitance	Capacitance Tolerance	Part Number
0.80mm	100Vdc	0.5pF	±0.1pF	CL10C0R5BCAGQW□
	250Vdc	0.1pF	±0.05pF	CL10C0R1AEAGQW□
		0.1pF	±0.1pF	CL10C0R1BEAGQW□
		0.2pF	±0.05pF	CL10C0R2AEAGQW□
		0.2pF	±0.1pF	CL10C0R2BEAGQW□
		0.3pF	±0.05pF	CL10C0R3AEAGQW□
		0.3pF	±0.1pF	CL10C0R3BEAGQW□
		0.3pF	±0.25pF	CL10C0R3CEAGQW□
		0.4pF	±0.05pF	CL10C0R4AEAGQW□
		0.4pF	±0.1pF	CL10C0R4BEAGQW□
		0.4pF	±0.25pF	CL10C0R4CEAGQW□
		0.5pF	±0.05pF	CL10C0R5AEAGQW□
		0.5pF	±0.1pF	CL10C0R5BEAGQW□
		0.5pF	±0.25pF	CL10C0R5CEAGQW□
		0.6pF	±0.05pF	CL10C0R6AEAGQW□
		0.6pF	±0.1pF	CL10C0R6BEAGQW□
		0.6pF	±0.25pF	CL10C0R6CEAGQW□
		0.7pF	±0.05pF	CL10C0R7AEAGQW□
		0.7pF	±0.1pF	CL10C0R7BEAGQW□
		0.7pF	±0.25pF	CL10C0R7CEAGQW□
		0.8pF	±0.05pF	CL10C0R8AEAGQW□
		0.8pF	±0.1pF	CL10C0R8BEAGQW□
		0.8pF	±0.25pF	CL10C0R8CEAGQW□
		0.9pF	±0.05pF	CL10C0R9AEAGQW□
		0.9pF	±0.1pF	CL10C0R9BEAGQW□
		0.9pF	±0.25pF	CL10C0R9CEAGQW□
		1.0pF	±0.05pF	CL10C010AEAGQW□
		1.0pF	±0.1pF	CL10C010BEAGQW□
		1.0pF	±0.25pF	CL10C010CEAGQW□
		1.1pF	±0.05pF	CL10C1R1AEAGQW□
		1.1pF	±0.1pF	CL10C1R1BEAGQW□
		1.1pF	±0.25pF	CL10C1R1CEAGQW□
		1.2pF	±0.05pF	CL10C1R2AEAGQW□
		1.2pF	±0.1pF	CL10C1R2BEAGQW□
		1.2pF	±0.25pF	CL10C1R2CEAGQW□
		1.3pF	±0.05pF	CL10C1R3AEAGQW□
		1.3pF	±0.1pF	CL10C1R3BEAGQW□
		1.3pF	±0.25pF	CL10C1R3CEAGQW□
		1.5pF	±0.05pF	CL10C1R5AEAGQW□
		1.5pF	±0.1pF	CL10C1R5BEAGQW□
1.5pF	±0.25pF	CL10C1R5CEAGQW□		
1.6pF	±0.05pF	CL10C1R6AEAGQW□		
1.6pF	±0.1pF	CL10C1R6BEAGQW□		
1.6pF	±0.25pF	CL10C1R6CEAGQW□		
1.8pF	±0.05pF	CL10C1R8AEAGQW□		
1.8pF	±0.1pF	CL10C1R8BEAGQW□		
1.8pF	±0.25pF	CL10C1R8CEAGQW□		
2.0pF	±0.05pF	CL10C020AEAGQW□		
2.0pF	±0.1pF	CL10C020BEAGQW□		
2.0pF	±0.25pF	CL10C020CEAGQW□		
2.2pF	±0.05pF	CL10C2R2AEAGQW□		
2.2pF	±0.1pF	CL10C2R2BEAGQW□		
2.2pF	±0.25pF	CL10C2R2CEAGQW□		
2.4pF	±0.05pF	CL10C2R4AEAGQW□		

※ □ mark means packaging code. If you want to learn the code or quantity in detail, please see p.148

In order to move to the page directly, please click the here. ↑

Product Line Up (COG)

■ Size : 1.60 X 0.80mm (inch : 0603)

Thickness Max.	Rated Voltage	Capacitance	Capacitance Tolerance	Part Number	Thickness Max.	Rated Voltage	Capacitance	Capacitance Tolerance	Part Number
0.80mm	250Vdc	2.4pF	±0.1pF	CL10C2R4BEAGQW□	0.80mm	250Vdc	7.5pF	±0.1pF	CL10C7R5BEAGQW□
		2.4pF	±0.25pF	CL10C2R4CEAGQW□			7.5pF	±0.25pF	CL10C7R5CEAGQW□
		2.7pF	±0.05pF	CL10C2R7AEAGQW□			7.5pF	±0.5pF	CL10C7R5DEAGQW□
		2.7pF	±0.1pF	CL10C2R7BEAGQW□			8.0pF	±0.05pF	CL10C080AEAGQW□
		2.7pF	±0.25pF	CL10C2R7CEAGQW□			8.0pF	±0.1pF	CL10C080BEAGQW□
		3.0pF	±0.05pF	CL10C030AEAGQW□			8.0pF	±0.25pF	CL10C080CEAGQW□
		3.0pF	±0.1pF	CL10C030BEAGQW□			8.0pF	±0.5pF	CL10C080DEAGQW□
		3.0pF	±0.25pF	CL10C030CEAGQW□			8.2pF	±0.05pF	CL10C8R2AEAGQW□
		3.3pF	±0.05pF	CL10C3R3AEAGQW□			8.2pF	±0.1pF	CL10C8R2BEAGQW□
		3.3pF	±0.1pF	CL10C3R3BEAGQW□			8.2pF	±0.25pF	CL10C8R2CEAGQW□
		3.3pF	±0.25pF	CL10C3R3CEAGQW□			8.2pF	±0.5pF	CL10C8R2DEAGQW□
		3.6pF	±0.05pF	CL10C3R6AEAGQW□			9.0pF	±0.05pF	CL10C090AEAGQW□
		3.6pF	±0.1pF	CL10C3R6BEAGQW□			9.0pF	±0.1pF	CL10C090BEAGQW□
		3.6pF	±0.25pF	CL10C3R6CEAGQW□			9.0pF	±0.25pF	CL10C090CEAGQW□
		3.9pF	±0.05pF	CL10C3R9AEAGQW□			9.0pF	±0.5pF	CL10C090DEAGQW□
		3.9pF	±0.1pF	CL10C3R9BEAGQW□			9.1pF	±0.05pF	CL10C9R1AEAGQW□
		3.9pF	±0.25pF	CL10C3R9CEAGQW□			9.1pF	±0.1pF	CL10C9R1BEAGQW□
		4.0pF	±0.05pF	CL10C040AEAGQW□			9.1pF	±0.25pF	CL10C9R1CEAGQW□
		4.0pF	±0.1pF	CL10C040BEAGQW□			9.1pF	±0.5pF	CL10C9R1DEAGQW□
		4.0pF	±0.25pF	CL10C040CEAGQW□			10pF	±1%	CL10C100FEAGQW□
		4.3pF	±0.05pF	CL10C4R3AEAGQW□			10pF	±2%	CL10C100GEAGQW□
		4.3pF	±0.1pF	CL10C4R3BEAGQW□			10pF	±5%	CL10C100JEAGQW□
		4.3pF	±0.25pF	CL10C4R3CEAGQW□			11pF	±1%	CL10C110FEAGQW□
		4.7pF	±0.05pF	CL10C4R7AEAGQW□			11pF	±2%	CL10C110GEAGQW□
		4.7pF	±0.1pF	CL10C4R7BEAGQW□			11pF	±5%	CL10C110JEAGQW□
		4.7pF	±0.25pF	CL10C4R7CEAGQW□			12pF	±1%	CL10C120FEAGQW□
		5.0pF	±0.05pF	CL10C050AEAGQW□			12pF	±2%	CL10C120GEAGQW□
		5.0pF	±0.1pF	CL10C050BEAGQW□			12pF	±5%	CL10C120JEAGQW□
		5.0pF	±0.25pF	CL10C050CEAGQW□			15pF	±1%	CL10C150FEAGQW□
		5.1pF	±0.05pF	CL10C5R1AEAGQW□			15pF	±2%	CL10C150GEAGQW□
		5.1pF	±0.1pF	CL10C5R1BEAGQW□			15pF	±5%	CL10C150JEAGQW□
		5.1pF	±0.25pF	CL10C5R1CEAGQW□			18pF	±1%	CL10C180FEAGQW□
		5.1pF	±0.5pF	CL10C5R1DEAGQW□			18pF	±2%	CL10C180GEAGQW□
		5.6pF	±0.05pF	CL10C5R6AEAGQW□			18pF	±5%	CL10C180JEAGQW□
		5.6pF	±0.1pF	CL10C5R6BEAGQW□			20pF	±1%	CL10C200FEAGQW□
		5.6pF	±0.25pF	CL10C5R6CEAGQW□			20pF	±2%	CL10C200GEAGQW□
		5.6pF	±0.5pF	CL10C5R6DEAGQW□			20pF	±5%	CL10C200JEAGQW□
		6.0pF	±0.05pF	CL10C060AEAGQW□			22pF	±1%	CL10C220FEAGQW□
		6.0pF	±0.1pF	CL10C060BEAGQW□			22pF	±2%	CL10C220GEAGQW□
		6.0pF	±0.25pF	CL10C060CEAGQW□			22pF	±5%	CL10C220JEAGQW□
6.0pF	±0.5pF	CL10C060DEAGQW□	24pF	±2%	CL10C240GEAGQW□				
6.2pF	±0.05pF	CL10C6R2AEAGQW□	24pF	±5%	CL10C240JEAGQW□				
6.2pF	±0.1pF	CL10C6R2BEAGQW□	27pF	±1%	CL10C270FEAGQW□				
6.2pF	±0.25pF	CL10C6R2CEAGQW□	27pF	±2%	CL10C270GEAGQW□				
6.2pF	±0.5pF	CL10C6R2DEAGQW□	27pF	±5%	CL10C270JEAGQW□				
6.8pF	±0.05pF	CL10C6R8AEAGQW□	33pF	±1%	CL10C330FEAGQW□				
6.8pF	±0.1pF	CL10C6R8BEAGQW□	33pF	±2%	CL10C330GEAGQW□				
6.8pF	±0.25pF	CL10C6R8CEAGQW□	33pF	±5%	CL10C330JEAGQW□				
6.8pF	±0.5pF	CL10C6R8DEAGQW□	39pF	±1%	CL10C390FEAGQW□				
7.0pF	±0.05pF	CL10C070AEAGQW□	39pF	±2%	CL10C390GEAGQW□				
7.0pF	±0.1pF	CL10C070BEAGQW□	39pF	±5%	CL10C390JEAGQW□				
7.0pF	±0.25pF	CL10C070CEAGQW□	47pF	±1%	CL10C470FEAGQW□				
7.0pF	±0.5pF	CL10C070DEAGQW□	47pF	±2%	CL10C470GEAGQW□				
7.5pF	±0.05pF	CL10C7R5AEAGQW□	47pF	±5%	CL10C470JEAGQW□				

※ □ mark means packaging code. If you want to learn the code or quantity in detail, please see p.148

In order to move to the page directly, please click the here. ↑

Product Line Up (COG)

■ Size : 2.00 X 1.25mm (inch : 0805)

Thickness Max.	Rated Voltage	Capacitance	Capacitance Tolerance	Part Number	Thickness Max.	Rated Voltage	Capacitance	Capacitance Tolerance	Part Number
0.95mm	250Vdc	0.5pF	±0.05pF	CL21C0R5AECGNW□	0.95mm	250Vdc	3.6pF	±0.05pF	CL21C3R6AECGNW□
		0.5pF	±0.1pF	CL21C0R5BECGNW□			3.6pF	±0.1pF	CL21C3R6BECGNW□
		0.5pF	±0.25pF	CL21C0R5CECGNW□			3.6pF	±0.25pF	CL21C3R6CECGNW□
		0.6pF	±0.05pF	CL21C0R6AECGNW□			3.9pF	±0.05pF	CL21C3R9AECGNW□
		0.6pF	±0.1pF	CL21C0R6BECGNW□			3.9pF	±0.1pF	CL21C3R9BECGNW□
		0.6pF	±0.25pF	CL21C0R6CECGNW□			3.9pF	±0.25pF	CL21C3R9CECGNW□
		0.7pF	±0.05pF	CL21C0R7AECGNW□			4.0pF	±0.05pF	CL21C040AECGNW□
		0.7pF	±0.1pF	CL21C0R7BECGNW□			4.0pF	±0.1pF	CL21C040BECGNW□
		0.7pF	±0.25pF	CL21C0R7CECGNW□			4.0pF	±0.25pF	CL21C040CECGNW□
		0.8pF	±0.05pF	CL21C0R8AECGNW□			4.3pF	±0.05pF	CL21C4R3AECGNW□
		0.8pF	±0.1pF	CL21C0R8BECGNW□			4.3pF	±0.1pF	CL21C4R3BECGNW□
		0.8pF	±0.25pF	CL21C0R8CECGNW□			4.3pF	±0.25pF	CL21C4R3CECGNW□
		0.9pF	±0.05pF	CL21C0R9AECGNW□			4.7pF	±0.05pF	CL21C4R7AECGNW□
		0.9pF	±0.1pF	CL21C0R9BECGNW□			4.7pF	±0.1pF	CL21C4R7BECGNW□
		0.9pF	±0.25pF	CL21C0R9CECGNW□			4.7pF	±0.25pF	CL21C4R7CECGNW□
		1.0pF	±0.05pF	CL21C010AECGNW□			5.0pF	±0.05pF	CL21C050AECGNW□
		1.0pF	±0.1pF	CL21C010BECGNW□			5.0pF	±0.1pF	CL21C050BECGNW□
		1.0pF	±0.25pF	CL21C010CECGNW□			5.0pF	±0.25pF	CL21C050CECGNW□
		1.1pF	±0.05pF	CL21C1R1AECGNW□			5.1pF	±0.05pF	CL21C5R1AECGNW□
		1.1pF	±0.1pF	CL21C1R1BECGNW□			5.1pF	±0.1pF	CL21C5R1BECGNW□
		1.1pF	±0.25pF	CL21C1R1CECGNW□			5.1pF	±0.25pF	CL21C5R1CECGNW□
		1.2pF	±0.05pF	CL21C1R2AECGNW□			5.1pF	±0.5pF	CL21C5R1DECGNW□
		1.2pF	±0.1pF	CL21C1R2BECGNW□			5.6pF	±0.05pF	CL21C5R6AECGNW□
		1.2pF	±0.25pF	CL21C1R2CECGNW□			5.6pF	±0.1pF	CL21C5R6BECGNW□
		1.3pF	±0.05pF	CL21C1R3AECGNW□			5.6pF	±0.25pF	CL21C5R6CECGNW□
		1.3pF	±0.1pF	CL21C1R3BECGNW□			5.6pF	±0.5pF	CL21C5R6DECGNW□
		1.3pF	±0.25pF	CL21C1R3CECGNW□			6.0pF	±0.05pF	CL21C060AECGNW□
		1.5pF	±0.05pF	CL21C1R5AECGNW□			6.0pF	±0.1pF	CL21C060BECGNW□
		1.5pF	±0.1pF	CL21C1R5BECGNW□			6.0pF	±0.25pF	CL21C060CECGNW□
		1.5pF	±0.25pF	CL21C1R5CECGNW□			6.0pF	±0.5pF	CL21C060DECGNW□
		1.6pF	±0.05pF	CL21C1R6AECGNW□			6.2pF	±0.05pF	CL21C6R2AECGNW□
		1.6pF	±0.1pF	CL21C1R6BECGNW□			6.2pF	±0.1pF	CL21C6R2BECGNW□
		1.6pF	±0.25pF	CL21C1R6CECGNW□			6.2pF	±0.25pF	CL21C6R2CECGNW□
		1.8pF	±0.05pF	CL21C1R8AECGNW□			6.2pF	±0.5pF	CL21C6R2DECGNW□
		1.8pF	±0.1pF	CL21C1R8BECGNW□			6.8pF	±0.05pF	CL21C6R8AECGNW□
		1.8pF	±0.25pF	CL21C1R8CECGNW□			6.8pF	±0.1pF	CL21C6R8BECGNW□
		2.0pF	±0.05pF	CL21C020AECGNW□			6.8pF	±0.25pF	CL21C6R8CECGNW□
		2.0pF	±0.1pF	CL21C020BECGNW□			6.8pF	±0.5pF	CL21C6R8DECGNW□
		2.0pF	±0.25pF	CL21C020CECGNW□			7.0pF	±0.05pF	CL21C070AECGNW□
		2.2pF	±0.05pF	CL21C2R2AECGNW□			7.0pF	±0.1pF	CL21C070BECGNW□
2.2pF	±0.1pF	CL21C2R2BECGNW□	7.0pF	±0.25pF	CL21C070CECGNW□				
2.2pF	±0.25pF	CL21C2R2CECGNW□	7.0pF	±0.5pF	CL21C070DECGNW□				
2.4pF	±0.05pF	CL21C2R4AECGNW□	7.5pF	±0.05pF	CL21C7R5AECGNW□				
2.4pF	±0.1pF	CL21C2R4BECGNW□	7.5pF	±0.1pF	CL21C7R5BECGNW□				
2.4pF	±0.25pF	CL21C2R4CECGNW□	7.5pF	±0.25pF	CL21C7R5CECGNW□				
2.7pF	±0.05pF	CL21C2R7AECGNW□	7.5pF	±0.5pF	CL21C7R5DECGNW□				
2.7pF	±0.1pF	CL21C2R7BECGNW□	8.0pF	±0.05pF	CL21C080AECGNW□				
2.7pF	±0.25pF	CL21C2R7CECGNW□	8.0pF	±0.1pF	CL21C080BECGNW□				
3.0pF	±0.05pF	CL21C030AECGNW□	8.0pF	±0.25pF	CL21C080CECGNW□				
3.0pF	±0.1pF	CL21C030BECGNW□	8.0pF	±0.5pF	CL21C080DECGNW□				
3.0pF	±0.25pF	CL21C030CECGNW□	8.2pF	±0.05pF	CL21C8R2AECGNW□				
3.3pF	±0.05pF	CL21C3R3AECGNW□	8.2pF	±0.1pF	CL21C8R2BECGNW□				
3.3pF	±0.1pF	CL21C3R3BECGNW□	8.2pF	±0.25pF	CL21C8R2CECGNW□				
3.3pF	±0.25pF	CL21C3R3CECGNW□	8.2pF	±0.5pF	CL21C8R2DECGNW□				

※ □ mark means packaging code. If you want to learn the code or quantity in detail, please see p.148

In order to move to the page directly, please click the here. †

Product Line Up (COG)

■ Size : 2.00 X 1.25mm (inch : 0805)

Thickness Max.	Rated Voltage	Capacitance	Capacitance Tolerance	Part Number	Thickness Max.	Rated Voltage	Capacitance	Capacitance Tolerance	Part Number
0.95mm	250Vdc	9.0pF	±0.05pF	CL21C090AECGNW□	0.95mm	250Vdc	100pF	±2%	CL21C101GECGNW□
		9.0pF	±0.1pF	CL21C090BECGNW□			100pF	±5%	CL21C101JECGNW□
		9.0pF	±0.25pF	CL21C090CECGNW□					
		9.0pF	±0.5pF	CL21C090DECGNW□					
		9.1pF	±0.05pF	CL21C9R1AECGNW□					
		9.1pF	±0.1pF	CL21C9R1BECGNW□					
		9.1pF	±0.25pF	CL21C9R1CECGNW□					
		9.1pF	±0.5pF	CL21C9R1DECGNW□					
		10pF	±1%	CL21C100FECGNW□					
		10pF	±2%	CL21C100GECGNW□					
		10pF	±5%	CL21C100JECGNW□					
		11pF	±1%	CL21C110FECGNW□					
		11pF	±2%	CL21C110GECGNW□					
		11pF	±5%	CL21C110JECGNW□					
		12pF	±1%	CL21C120FECGNW□					
		12pF	±2%	CL21C120GECGNW□					
		12pF	±5%	CL21C120JECGNW□					
		15pF	±1%	CL21C150FECGNW□					
		15pF	±2%	CL21C150GECGNW□					
		15pF	±5%	CL21C150JECGNW□					
		18pF	±1%	CL21C180FECGNW□					
		18pF	±2%	CL21C180GECGNW□					
		18pF	±5%	CL21C180JECGNW□					
		20pF	±1%	CL21C200FECGNW□					
		20pF	±2%	CL21C200GECGNW□					
		20pF	±5%	CL21C200JECGNW□					
		22pF	±1%	CL21C220FECGNW□					
		22pF	±2%	CL21C220GECGNW□					
		22pF	±5%	CL21C220JECGNW□					
		24pF	±1%	CL21C240FECGNW□					
		24pF	±2%	CL21C240GECGNW□					
		24pF	±5%	CL21C240JECGNW□					
		27pF	±1%	CL21C270FECGNW□					
		27pF	±2%	CL21C270GECGNW□					
		27pF	±5%	CL21C270JECGNW□					
		33pF	±1%	CL21C330FECGNW□					
		33pF	±2%	CL21C330GECGNW□					
		33pF	±5%	CL21C330JECGNW□					
		39pF	±1%	CL21C390FECGNW□					
		39pF	±2%	CL21C390GECGNW□					
		39pF	±5%	CL21C390JECGNW□					
		47pF	±1%	CL21C470FECGNW□					
47pF	±2%	CL21C470GECGNW□							
47pF	±5%	CL21C470JECGNW□							
62pF	±1%	CL21C620FECGNW□							
62pF	±2%	CL21C620GECGNW□							
62pF	±5%	CL21C620JECGNW□							
68pF	±1%	CL21C680FECGNW□							
68pF	±2%	CL21C680GECGNW□							
68pF	±5%	CL21C680JECGNW□							
82pF	±1%	CL21C820FECGNW□							
82pF	±2%	CL21C820GECGNW□							
82pF	±5%	CL21C820JECGNW□							
100pF	±1%	CL21C101FECGNW□							

※ □ mark means packaging code. If you want to learn the code or quantity in detail, please see p.148

In order to move to the page directly, please click the here. ↑

High Effective Capacitance Industrial Capacitors

N3W – X5R / X7R

Feature



- Excellent DC - bias characteristics with fine powder
- Enhance high temperature reliability
- Special outgoing inspection for industrial application (HALT, etc)
- Advantage of fine powder technology

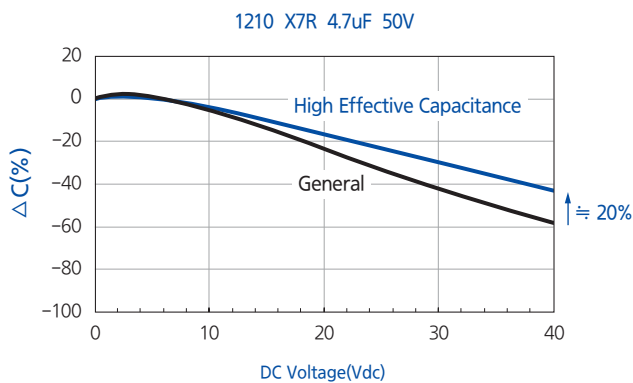

By using finer powder : Reduced capacitance degradation by bias and aging

Application

- 24 / 48V input line filter for power supply
- Network, Power application and etc.
- Ideal for decoupling and filtering applications (Class II : X7R)

Structure and Dimensions

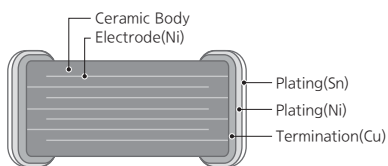
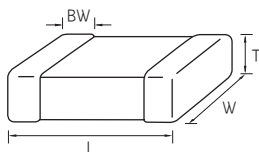

Size Code	EIA Code	Dimension(mm)				
		L	W	T	Thickness Code	BW
05	0402	1.00±0.05	0.50±0.05	0.50±0.05	5	0.25±0.10
21	0805	2.00±0.10	1.25±0.10	1.25±0.10	F	0.50+0.20/-0.30
31	1206	3.20±0.20	1.60±0.20	1.60±0.20	H	0.50±0.30
32	1210	3.20±0.30	2.50±0.20	2.50±0.20	J	0.60±0.30
		3.20±0.40	2.50±0.30	2.50±0.30	V	

Industrial Capacitance Table (X5R)

Size inch (mm)	Rated Voltage (Vdc)	Capacitance													
		nF					uF								
		10	22	47	100	220	470	1.0	2.2	4.7	6.8	10			
0805(2012)	6.3														

Industrial Capacitance Table (X7R)

Size inch (mm)	Rated Voltage (Vdc)	Capacitance													
		nF					uF								
		10	22	47	100	220	470	1.0	2.2	4.7	6.8	10			
0402(1005)	16														
1206 (3216)	50														
	100														
1210 (3225)	50														
	100														

Product Line Up (X5R)

■ Size : 2.00 X 1.25mm (inch : 0805)

Thickness Max.	Rated Voltage	Capacitance	Capacitance Tolerance	Part Number	Remark
1.35mm	6.3Vdc	10uF	±10%	CL21A106KQFN3W□	

Product Line Up (X7R)

■ Size : 1.00 X 0.50mm (inch : 0402)

Thickness Max.	Rated Voltage	Capacitance	Capacitance Tolerance	Part Number	Remark
0.55mm	16Vdc	100nF	±10%	CL05B104K05N3W□	

■ Size : 3.20 X 1.60mm (inch : 1206)

Thickness Max.	Rated Voltage	Capacitance	Capacitance Tolerance	Part Number	Remark
1.80mm	50Vdc	4.7uF	±10%	CL31B475KBHN3W□	

■ Size : 3.20 X 2.50mm (inch : 1210)

Thickness Max.	Rated Voltage	Capacitance	Capacitance Tolerance	Part Number	Remark
2.70mm	50Vdc	10uF	±10%	CL32B106KBJN3W□	
		4.7uF	±10%	CL32B475KBJN3W□	

※ □ mark means packaging code. If you want to learn the code or quantity in detail, please see p.148
In order to move to the page directly, please click the here. ↑

Reliability Test Condition

No.	Item	Performance	Test condition									
1	Appearance	No abnormal exterior appearance	Visual Inspection through Microscope (X10)									
2	Insulation resistance	10,000MΩ min. or 500MΩ ·μF min.(or*100MΩ ·μF) product whichever is smaller. (Rated voltage ≤16V:10,000MΩ min. or 100MΩ ·μF min. product whichever is smaller)	Apply the rated voltage for 60 ~ 120sec. Rated voltage > 500V : Insulation resistance shall be measured with 500±50Vdc									
3	Withstanding voltage	No dielectric breakdown or mechanical breakdown	Apply the specified voltage* for 1 ~ 5 sec. Charge / Discharge current limit : 50mA max *CLASS I (Rated Voltage < 100V) : 300% of the rated Voltage CLASS II (Rated Voltage < 100V) : 250% of the rated Voltage In the case of rated Voltage ≥ 100V products, following condition should be applied. 100V ≤ Rated Voltage < 500V : 200% of the rated Voltage 500V ≤ Rated Voltage < 1000V : 150% of the rated Voltage Rated Voltage ≥ 1000V : 120% of the rated Voltage									
4	Capacitance	Class I	Within the specified tolerance									
		Class II	Within the specified tolerance									
5	Q	Class I	Capacitance ≥ 30pF : Q ≥ 1,000 < 30pF : Q ≥ 400+20×C (C : Capacitance)									
	Tanδ	Class II	1.Characteristic : A(X5R) <table border="1"> <thead> <tr> <th>Rated Voltage</th> <th>Spec</th> </tr> </thead> <tbody> <tr> <td>50V /35V</td> <td>0.025 max / 0.05 max*</td> </tr> <tr> <td>25V</td> <td>0.025 max / 0.05 max* / 0.10 max*</td> </tr> <tr> <td>16V</td> <td>0.035 max / 0.05 max* / 0.10 max*</td> </tr> <tr> <td>≤10V</td> <td>0.05 max / 0.10 max*</td> </tr> </tbody> </table>	Rated Voltage	Spec	50V /35V	0.025 max / 0.05 max*	25V	0.025 max / 0.05 max* / 0.10 max*	16V	0.035 max / 0.05 max* / 0.10 max*	≤10V
Rated Voltage			Spec									
50V /35V			0.025 max / 0.05 max*									
25V	0.025 max / 0.05 max* / 0.10 max*											
16V	0.035 max / 0.05 max* / 0.10 max*											
≤10V	0.05 max / 0.10 max*											
2.Characteristic : B(X7R), X(X6S), Y(X7S) <table border="1"> <thead> <tr> <th>Rated Voltage</th> <th>Spec</th> </tr> </thead> <tbody> <tr> <td>50V ≥ / 35V / 25V</td> <td>0.025 max / 0.05 max* / 0.10 max*</td> </tr> <tr> <td>16V</td> <td>0.035 max / 0.10 max*</td> </tr> <tr> <td>≤10V</td> <td>0.05 max / 0.10 max*</td> </tr> </tbody> </table>	Rated Voltage	Spec	50V ≥ / 35V / 25V	0.025 max / 0.05 max* / 0.10 max*	16V	0.035 max / 0.10 max*	≤10V	0.05 max / 0.10 max*				
Rated Voltage	Spec											
50V ≥ / 35V / 25V	0.025 max / 0.05 max* / 0.10 max*											
16V	0.035 max / 0.10 max*											
≤10V	0.05 max / 0.10 max*											
3.Characteristic : F(Y5V) <table border="1"> <thead> <tr> <th>Rated Voltage</th> <th>Spec</th> </tr> </thead> <tbody> <tr> <td>50V / 35V / 25V</td> <td>0.05 max / 0.07 max* / 0.09 max*</td> </tr> <tr> <td>16V</td> <td>0.07 max / 0.09 max* / 0.125 max*</td> </tr> <tr> <td>10V</td> <td>0.125 max / 0.16 max*</td> </tr> <tr> <td>≤ 6.3V</td> <td>0.16 max</td> </tr> </tbody> </table>	Rated Voltage	Spec	50V / 35V / 25V	0.05 max / 0.07 max* / 0.09 max*	16V	0.07 max / 0.09 max* / 0.125 max*	10V	0.125 max / 0.16 max*	≤ 6.3V	0.16 max		
Rated Voltage	Spec											
50V / 35V / 25V	0.05 max / 0.07 max* / 0.09 max*											
16V	0.07 max / 0.09 max* / 0.125 max*											
10V	0.125 max / 0.16 max*											
≤ 6.3V	0.16 max											

■ Class I

Capacitance	Frequency	Voltage
≤1,000pF	1kHz ±10%	0.5 ~ 5Vrms
>1,000pF	1kHz ±10%	

■ Class II

Capacitance	Frequency	Voltage
≤10μF	1kHz ±10%	1.0±0.2Vrms
>10μF	120Hz ±20%	0.5±0.1Vrms
Exception*	1kHz ±10%	0.5±0.1Vrms

Capacitance shall be measured after the heat treatment of 150+0/-10°C for 1hr and leaving for 24±2hr at room temperature. (Class II)

* The conditions of measurement may be altered upon request.
You can check the specification at the web site or contact sales people for each product with mark*

| 6 | Temperature characteristics of capacitance | Class I | | Characteristic | Temp. coefficient (PPM/°C) | |----------------|----------------------------| | C(COG) | 0±30 | |
| Class II | | Characteristic | Capacitance change(%) with No bias | |-----------------|------------------------------------| | A(X5R) / B(X7R) | ±15% | | X(X6S) / Y(X7S) | ±22% | | Z(X7T) | +22% ~ -33% | | F(Y5V) | +22% ~ -82% | |

Capacitance shall be measured by the steps shown in the following table.

Step	Temperature(°C)
1	25±2
2	Min. operating temp. ±2
3	25±2
4	Max. operating temp. ±2
5	25±2

■ Class I
Temperature Coefficient shall be calculated from the formula as below
Temp. Coefficient = $\frac{C2 - C1}{C1 \times \Delta T} \times 10^6$ [ppm/°C]
C1 : Capacitance at step 3
C2 : Capacitance at 125°C
ΔT : 125°C - 25°C = 100°C

■ Class II
Capacitance change shall be calculated from the formula as below
 $\Delta C = \frac{C2 - C1}{C1} \times 100(\%)$
C1 : Capacitance at step 3
C2 : Capacitance at step 2 or step 4

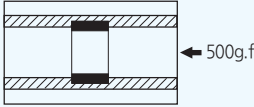
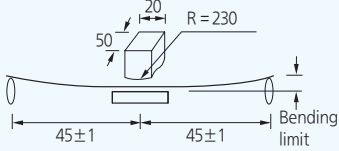
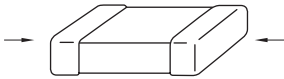
No.	Item	Performance	Test condition											
7	Adhesive strength of termination	No indication of peeling shall occur on the terminal electrode.	Apply 500g.f pressure for 10±1 sec. ※ 200g.f for size 0201 / 100g.f for size 01005 											
8	Bending strength	Appearance	No mechanical damage shall occur.											
		Capacitance	<table border="1"> <thead> <tr> <th>Characteristic</th> <th>Capacitance change</th> </tr> </thead> <tbody> <tr> <td>Class I</td> <td>Within ±5% or ±0.5pF whichever is larger</td> </tr> <tr> <td rowspan="3">Class II</td> <td>A(X5R), B(X7R), X(X6S), Y(X7S), Z(X7T)</td> <td>Within ±12.5%</td> </tr> <tr> <td>F(Y5V)</td> <td>Within ±30%</td> </tr> </tbody> </table>	Characteristic	Capacitance change	Class I	Within ±5% or ±0.5pF whichever is larger	Class II	A(X5R), B(X7R), X(X6S), Y(X7S), Z(X7T)	Within ±12.5%	F(Y5V)	Within ±30%		
Characteristic	Capacitance change													
Class I	Within ±5% or ±0.5pF whichever is larger													
Class II	A(X5R), B(X7R), X(X6S), Y(X7S), Z(X7T)	Within ±12.5%												
	F(Y5V)	Within ±30%												
			• Bending Limit : 1mm • Test Speed : 1.0mm /sec. Keep the test board at the limit point in 5sec. then Measure Capacitance. ※ Industrial Capacitor - SW6 / ZW6 / Z46 Code, Bending Limit : 3mm - Z4J Code, Bending Limit : 5mm 											
9	Solderability	More than 75% of the terminal surface is to be soldered newly, so metal part does not come out or dissolve ※ Industrial Capacitor : Z46 / Z4J Code, More than 95% 	<table border="1"> <thead> <tr> <th>Solder</th> <th>Sn_Ag3_0.5Cu</th> </tr> </thead> <tbody> <tr> <td>Solder temp.</td> <td>245±5°C</td> </tr> <tr> <td>Flux</td> <td>RMA Type</td> </tr> <tr> <td>Dip time</td> <td>3±0.3sec.</td> </tr> <tr> <td>Pre-heating</td> <td>at 80~120°C for 10~30sec.</td> </tr> </tbody> </table>	Solder	Sn_Ag3_0.5Cu	Solder temp.	245±5°C	Flux	RMA Type	Dip time	3±0.3sec.	Pre-heating	at 80~120°C for 10~30sec.	
Solder	Sn_Ag3_0.5Cu													
Solder temp.	245±5°C													
Flux	RMA Type													
Dip time	3±0.3sec.													
Pre-heating	at 80~120°C for 10~30sec.													
10	Resistance to soldering heat	Appearance	No mechanical damage shall occur.											
		Capacitance	<table border="1"> <thead> <tr> <th>Characteristic</th> <th>Capacitance change</th> </tr> </thead> <tbody> <tr> <td>Class I</td> <td>±2.5% or ±0.25pF whichever is larger</td> </tr> <tr> <td rowspan="3">Class II</td> <td>A(X5R), B(X7R), X(X6S), Y(X7S), Z(X7T)</td> <td>Within ±7.5%</td> </tr> <tr> <td>F(Y5V)</td> <td>Within ±20%</td> </tr> </tbody> </table>	Characteristic	Capacitance change	Class I	±2.5% or ±0.25pF whichever is larger	Class II	A(X5R), B(X7R), X(X6S), Y(X7S), Z(X7T)	Within ±7.5%	F(Y5V)	Within ±20%		
		Characteristic	Capacitance change											
		Class I	±2.5% or ±0.25pF whichever is larger											
		Class II	A(X5R), B(X7R), X(X6S), Y(X7S), Z(X7T)	Within ±7.5%										
			F(Y5V)	Within ±20%										
Q (Class I)	Within the specified initial value													
Tanδ (Class II)	Within the specified initial value													
Insulation resistance	Within the specified initial value													
Withstanding voltage	No breakdown of dielectric													
		Solder temperature: 270±5°C DIP TIME : 10±1 sec. Each termination shall be fully immersed and preheated as below : <table border="1"> <thead> <tr> <th>Step</th> <th>Temp.(°C)</th> <th>Time(sec.)</th> </tr> </thead> <tbody> <tr> <td>1</td> <td>80~100</td> <td>60</td> </tr> <tr> <td>2</td> <td>150~180</td> <td>60</td> </tr> </tbody> </table>	Step	Temp.(°C)	Time(sec.)	1	80~100	60	2	150~180	60			
Step	Temp.(°C)	Time(sec.)												
1	80~100	60												
2	150~180	60												
11	Vibration test	Appearance	No mechanical damage shall occur.											
		Capacitance	<table border="1"> <thead> <tr> <th>Characteristic</th> <th>Capacitance change</th> </tr> </thead> <tbody> <tr> <td>Class I</td> <td>±2.5% or ±0.25pF whichever is larger</td> </tr> <tr> <td rowspan="3">Class II</td> <td>A(X5R), B(X7R)</td> <td>Within ±5%</td> </tr> <tr> <td>X(X6S), Y(X7S), Z(X7T)</td> <td>Within ±5%</td> </tr> <tr> <td>F(Y5V)</td> <td>Within ±10%</td> </tr> </tbody> </table>	Characteristic	Capacitance change	Class I	±2.5% or ±0.25pF whichever is larger	Class II	A(X5R), B(X7R)	Within ±5%	X(X6S), Y(X7S), Z(X7T)	Within ±5%	F(Y5V)	Within ±10%
		Characteristic	Capacitance change											
		Class I	±2.5% or ±0.25pF whichever is larger											
		Class II	A(X5R), B(X7R)	Within ±5%										
			X(X6S), Y(X7S), Z(X7T)	Within ±5%										
F(Y5V)	Within ±10%													
Q (Class I)	Within the specified initial value													
Tanδ (Class II)	Within the specified initial value													
Insulation resistance	Within the specified initial value													
		The capacitor shall be subjected to a harmonic motion having a total amplitude of 1.5mm changing frequency from 10Hz to 55Hz and back to 10Hz in about 1 min. Repeat this for 2hours each in 3mutually perpendicular directions ※ Industrial Capacitor : Z46 / Z4J Code With frequency from 10 ~ 2000Hz during 20min. 3 directions X 12 times (total 36 times, 12hr) Perform the initial measurement according to Note1. Please refer to p.131 Final measurement Leave the capacitor in ambient condition for 24±2 hours before measurement. Then perform the measurement.												

Reliability Test Condition

No.	Item	Performance	Test condition									
12	Appearance	No mechanical damage shall occur.	Applied voltage : Rated Voltage									
	Capacitance	<table border="1"> <thead> <tr> <th>Characteristic</th> <th>Capacitance change</th> </tr> </thead> <tbody> <tr> <td>Class I</td> <td>$\pm 7.5\%$ or $\pm 0.75\text{pF}$ whichever is larger</td> </tr> <tr> <td rowspan="2">Class II</td> <td>A(X5R), B(X7R), X(X6S), Y(X7S), Z(X7T)</td> <td>Within $\pm 12.5\%$</td> </tr> <tr> <td>F(Y5V)</td> <td>$\pm 30\%$</td> </tr> </tbody> </table>	Characteristic	Capacitance change	Class I	$\pm 7.5\%$ or $\pm 0.75\text{pF}$ whichever is larger	Class II	A(X5R), B(X7R), X(X6S), Y(X7S), Z(X7T)	Within $\pm 12.5\%$	F(Y5V)	$\pm 30\%$	Temperature : $40 \pm 2^\circ\text{C}$ Humidity : 90-95%RH Duration time : 500+12/-0hr. Charge / Discharge current : 50mA max.
		Characteristic	Capacitance change									
		Class I	$\pm 7.5\%$ or $\pm 0.75\text{pF}$ whichever is larger									
		Class II	A(X5R), B(X7R), X(X6S), Y(X7S), Z(X7T)	Within $\pm 12.5\%$								
	F(Y5V)		$\pm 30\%$									
Q (Class I)	Capacitance $\geq 30\text{pF}$: $Q \geq 200$ $< 30\text{pF}$: $Q \geq 100 + 10 / 3 \times C$ (C : Capacitance)	※ Industrial Capacitor : Z46 / Z4J Code $85 \pm 2^\circ\text{C}$, 80-85%RH, 1000+48/-0hr.										
Tan δ (Class II)	<ol style="list-style-type: none"> Capacitance : A(X5R) 0.05 max / 0.075 max* (35V / 50V) 0.05 max / 0.075 max* / 0.125 max* (16V / 25V) 0.075 max / 0.125 max* ($\leq 10\text{V}$) Capacitance : B(X7R), X(X6S) 0.05 max / 0.125 max* (16V / 25V / 35V / 50V \geq) 0.075 max / 0.125 max* ($\leq 10\text{V}$) Capacitance : F(Y5V) 0.09 max (50V) 0.09 max / 0.125 max* (25V / 35V) 0.09 max / 0.125 max* / 0.16 max* (16V) 0.16 max / 0.195 max* (10V) 0.195 max (4V / 6.3V) Industrial Capacitor : Z46 / Z4J Code 0.035 max* ($\geq 25\text{V}$) 0.050 max* (16V) 0.075 max* (10V) 	Perform the initial measurement according to Note1. Perform the final measurement according to Note2. Please refer to p.131										
Insulation resistance	500M Ω min. or 25M Ω · μF min. product whichever is smaller / 12.5M Ω · μF or over*	This test is only applied to Rated Voltage $\leq 500\text{V}$ products. You can check the specification at the web site or contact sales people for each product with mark*										
13	Appearance	No mechanical damage shall occur.	Temperature : Max. operating temperature									
	Capacitance	<table border="1"> <thead> <tr> <th>Characteristic</th> <th>Capacitance change</th> </tr> </thead> <tbody> <tr> <td>Class I</td> <td>$\pm 3\%$ or $\pm 0.30\text{pF}$ whichever is larger</td> </tr> <tr> <td rowspan="2">Class II</td> <td>A(X5R), B(X7R), X(X6S), Y(X7S), Z(X7T)</td> <td>Within $\pm 12.5\%$</td> </tr> <tr> <td>F(Y5V)</td> <td>30%</td> </tr> </tbody> </table>	Characteristic	Capacitance change	Class I	$\pm 3\%$ or $\pm 0.30\text{pF}$ whichever is larger	Class II	A(X5R), B(X7R), X(X6S), Y(X7S), Z(X7T)	Within $\pm 12.5\%$	F(Y5V)	30%	Duration Time: 1000+48/-0hr. Charge / Discharge Current : 50mAmax. Apply Voltage : 100% of Rated Voltage* It depends on each item (120% / 150% / 200% Rated Voltage)
		Characteristic	Capacitance change									
		Class I	$\pm 3\%$ or $\pm 0.30\text{pF}$ whichever is larger									
		Class II	A(X5R), B(X7R), X(X6S), Y(X7S), Z(X7T)	Within $\pm 12.5\%$								
	F(Y5V)		30%									
Q (Class I)	Capacitance $\geq 30\text{pF}$: $Q \geq 350$ $10\text{pF} \leq \text{Capacitance} < 30\text{pF}$: $Q \geq 275 + 2.5 \times C$ Capacitance $< 10\text{pF}$: $Q \geq 200 + 10 \times C$ (C : Capacitance)	Perform the initial measurement according to Note1. Perform the final measurement according to Note2. Please refer to p.131										
Tan δ (Class II)	<ol style="list-style-type: none"> Capacitance : A(X5R) 0.05 max / 0.075 max* (35V / 50V) 0.05 max / 0.075 max* / 0.125 max* (16V / 25V) 0.075 max / 0.125 max* ($\leq 10\text{V}$) Capacitance : B(X7R), X(X6S) 0.05 max / 0.125 max* (16V / 25V / 35V / 50V \geq) 0.075 max / 0.125 max* ($\leq 10\text{V}$) Capacitance : F(Y5V) 0.09 max (50V) 0.09 max / 0.125 max* (25V / 35V) 0.09 max / 0.125 max* / 0.16 max* (16V) 0.16 max / 0.195 max* (10V) 0.195 max (4V / 6.3V) Industrial Capacitor : Z46 / Z4J Code 0.035 max* ($\geq 25\text{V}$) 0.050 max* (16V) 0.075 max* (10V) 											
Insulation resistance	1,000M Ω min. or 50M Ω · μF min. product whichever is smaller / 25M Ω · μF or over*	You can check the specification at the web site or contact sales people for each product with mark*										

No.	Item	Performance	Test condition																													
14	Temperature cycle	Appearance	No mechanical damage shall occur.																													
		Capacitance	<table border="1"> <thead> <tr> <th>Characteristic</th> <th>Capacitance change</th> </tr> </thead> <tbody> <tr> <td>Class I</td> <td>$\pm 2.5\%$ or $\pm 0.25\text{pF}$ whichever is larger</td> </tr> <tr> <td rowspan="4">Class II</td> <td>A(X5R)</td> <td>Within $\pm 7.5\%$ / $\pm 10\%$ / $\pm 15\%*$</td> </tr> <tr> <td>B(X7R)</td> <td>Within $\pm 7.5\%$</td> </tr> <tr> <td>X(X6S), Y(X7S) Z(X7T)</td> <td>Within $\pm 15\%$</td> </tr> <tr> <td>F(Y5V)</td> <td>Within $\pm 20\%$</td> </tr> </tbody> </table>	Characteristic	Capacitance change	Class I	$\pm 2.5\%$ or $\pm 0.25\text{pF}$ whichever is larger	Class II	A(X5R)	Within $\pm 7.5\%$ / $\pm 10\%$ / $\pm 15\%*$	B(X7R)	Within $\pm 7.5\%$	X(X6S), Y(X7S) Z(X7T)	Within $\pm 15\%$	F(Y5V)	Within $\pm 20\%$	Capacitor shall be subjected to 5 cycles. ※ Industrial Capacitor : Z46 / Z4J Code, 1000 cycles. Condition for 1 cycle : <table border="1"> <thead> <tr> <th>Step</th> <th>Temp.(°C)</th> <th>Time(min.)</th> </tr> </thead> <tbody> <tr> <td>1</td> <td>Min. operating temperature +0 / -3</td> <td>30</td> </tr> <tr> <td>2</td> <td>25</td> <td>2 ~ 3</td> </tr> <tr> <td>3</td> <td>Max. operating temperature +3 / -0</td> <td>30</td> </tr> <tr> <td>4</td> <td>25</td> <td>2 ~ 3</td> </tr> </tbody> </table>	Step	Temp.(°C)	Time(min.)	1	Min. operating temperature +0 / -3	30	2	25	2 ~ 3	3	Max. operating temperature +3 / -0	30	4	25	2 ~ 3
			Characteristic	Capacitance change																												
			Class I	$\pm 2.5\%$ or $\pm 0.25\text{pF}$ whichever is larger																												
			Class II	A(X5R)	Within $\pm 7.5\%$ / $\pm 10\%$ / $\pm 15\%*$																											
				B(X7R)	Within $\pm 7.5\%$																											
X(X6S), Y(X7S) Z(X7T)	Within $\pm 15\%$																															
F(Y5V)	Within $\pm 20\%$																															
Step	Temp.(°C)	Time(min.)																														
1	Min. operating temperature +0 / -3	30																														
2	25	2 ~ 3																														
3	Max. operating temperature +3 / -0	30																														
4	25	2 ~ 3																														
Q (Class I)	Within the specified initial value	Perform the initial measurement according to Note1. Please refer to p.131																														
Tanδ (Class II)	Within the specified initial value																															
Insulation resistance	Within the specified initial value																															
			Final measurement Leave the capacitor in ambient condition for 24±2 hours before measurement. Then perform the measurement.																													
15	Mechanical Shock (Only for Z46 / Z4J Code)	Appearance	No abnormal exterior appearance.																													
		Capacitance	<table border="1"> <thead> <tr> <th>Characteristic</th> <th>Capacitance change</th> </tr> </thead> <tbody> <tr> <td>Class II</td> <td>Within $\pm 10\%$</td> </tr> </tbody> </table>	Characteristic	Capacitance change	Class II	Within $\pm 10\%$	Three shocks in each direction should be applied along 3 mutually perpendicular axes of the test specimen (18 shocks) <table border="1"> <thead> <tr> <th>Peak value</th> <th>Duration</th> <th>Wave</th> <th>Velocity</th> </tr> </thead> <tbody> <tr> <td>1,500G</td> <td>0.5ms</td> <td>Half sine</td> <td>4.7m / sec</td> </tr> </tbody> </table>	Peak value	Duration	Wave	Velocity	1,500G	0.5ms	Half sine	4.7m / sec																
			Characteristic	Capacitance change																												
		Class II	Within $\pm 10\%$																													
Peak value	Duration	Wave	Velocity																													
1,500G	0.5ms	Half sine	4.7m / sec																													
Tanδ (Class II)	1. Capacitance : B(X7R) 0.025 max* (25V) 0.035 max* (16V) 0.050 max* (6.3V/10V)																															
IR	1,000MΩ min. or 50MΩ · μF min. product whichever is smaller / 12.5MΩ · μF or over*																															
			Perform the initial measurement according to Note1. Perform the final measurement according to Note2. Please refer to p.131																													

Recommended Soldering Method				
Size inch(mm)	Temperature Characteristic	Capacitance	Condition	
			Flow	Reflow
01005(0402)	-	-	-	○
0201(0603)				
0402(1005)				
0603(1608)	Class I	-	○	○
	Class II	C < 1uF	○	○
		C ≥ 1uF	-	○
0805(2012)	Class I	-	○	○
	Class II	C < 4.7uF	○	○
		C ≥ 4.7uF	-	○
	Array	-	-	○
1206(3216)	Class I	-	○	○
	Class II	C < 10uF	○	○
		C ≥ 10uF	-	○
	Array	-	-	○
1210(3225)	-	-	-	○
1808(4520)				
1812(4532)				
2220(5750)				

Note 1. Initial Measurement For Class II

Perform the heat treatment at 150°C +0 / -10°C for 1 hour and leave the capacitor in ambient condition for 24±2 hours before measurement. Then perform the measurement.

Note 2. Latter Measurement

1. CLASS I

Leave the capacitor in ambient condition for 24±2 hours before measurement. Then perform the measurement.

2. CLASS II

Perform the heat treatment at 150°C +0 / -10°C for 1 hour and leave the capacitor in ambient condition for 24±2 hours before measurement. Then perform the measurement.

Note 3. All Size in Reliability Test Condition Section is "inch"

Premium Capacitors for Automotive Applications

CL	10	B	104	K	B	8	W	P	N	C
1	2	3	4	5	6	7	8	9	10	11

1 SERIES CODE

CL = Multilayer Ceramic Capacitors

2 SIZE CODE

Code	inch(mm)	Code	inch(mm)	Code	inch(mm)
05	0402(1005)	21	0805(2012)	32	1210(3225)
10	0603(1608)	31	1206(3216)		

3 DIELECTRIC CODE

Class I

Symbol	EIA Code	Operation Temperature Range(°C)	Temperature Coefficient(ppm/°C)
C	COG	-55 ~ +125	0±30

Class II

Symbol	EIA Code	Operation Temperature Range(°C)	Capacitance Change(%)
B	X7R	-55 ~ +125	±15
Y	X7S	-55 ~ +125	±22

4 CAPACITANCE CODE

Capacitance expressed in pF. 2 significant digits plus number of zeros.

example) 106=10×10⁶=10,000,000pF

For Values <10pF, Letter R denotes decimal point

example) 1R5 =1.5pF

5 TOLERANCE CODE

Capacitance Tolerance

Code	Capacitance Tolerance	TC	Capacitance series	Remark
C	±0.25pF	C0G	E-12 series*	under 5pF
D	±0.5pF	C0G	E-12 series*	5pF < Cp < 10pF
J	±5%	C0G	E-12 series	≥ 10pF
K	±10%	X7R/X7S	E-6 series	
M	±20%	X7R/X7S	E-6 series	

* E-24 series is also available

※This code has only typical specifications. Please refer to individual specifications.

Series	Capacitance Step											
E-3	1.0				2.2				4.7			
E-6	1.0		1.5		2.2		3.3		4.7		6.8	
E-12	1.0	1.2	1.5	1.8	2.2	2.7	3.3	3.9	4.7	5.6	6.8	8.2
E-24	1.0	1.1	1.2	1.3	2.2	2.4	2.7	3.0	4.7	5.1	5.6	6.2
	1.5	1.6	1.8	2.0	3.3	3.6	3.9	4.3	6.8	7.5	8.2	9.1

6 RATED VOLTAGE CODE

Q = 6.3V P = 10V O = 16V A = 25V B = 50V C = 100V

7 THICKNESS CODE

(Unit:mm)

Size mm(inch)	Code	Thickness*	Tolerance
1005(0402)	5	0.50	±0.05
1608(0603)	8	0.80	±0.10
2012(0805)	6	0.60	±0.10
	C	0.85	±0.10
	F	1.25	±0.10
	Q	1.25	±0.15
3216(1206)	C	0.85	±0.15
	P	1.15	±0.10
	H	1.60	±0.20
3225(1210)	I	2.00	±0.20
	J	2.50	±0.20

* In case of Higher Bending Strength , ESD protection capacitors, Please refer to individual specifications.

※ This code has only typical specifications. Please refer to individual specifications.

8 DESIGN CODE

Code	Inner electrode	Termination	Plating material	Design
1	Ni	Cu	Ni_Sn 100%	Standard
V	Ni	Cu/Metal Epoxy	Ni_Sn 100%	Standard
W	Ni	Cu/Metal Epoxy	Ni_Sn 100%	Open Mode
X	Ni	Cu/Metal Epoxy	Ni_Sn 100%	Float Mode

※ This code has only typical specifications. Please refer to individual specifications.

9 PRODUCT CODE OR SIZE CONTROL CODE

P = Automotive product meet AEC –Q200.

10 CONTROL CODE

N = Standard J = Higher Bending Strength E = ESD Protection

11 PACKAGING CODE

Code	Type	Code	Type
C	Cardbord Tape, 7" reel	E	Embossed Tape, 7" reel
D/L	Cardbord Tape, 13" reel (Quantity option)	F	Embossed Tape, 13" reel

※ If you want to learn to the code or quantity in detail, please see page 148.

In order to move to the page directly, please click the here. ↑

General Automotive Capacitors

Feature



- Automotive products are manufactured in state of the art facilities recommend for registration to ISO / TS 16949 : 2002.
- Automotive products meet AEC – Q200 requirements.
- Automotive products are RoHS compliant.
- Automotive products meet JEDEC – 020 – D requirements.
- X7R dielectric components have BME and metal – epoxy terminations with a Ni / Sn plated overcoat.
- COG dielectric components contain BME and copper terminations with a Ni / Sn plated overcoat.
- Size 0603 / 0805 / 1206 is suitable for flow and reflow soldering.
- Size 0402 and smaller (≤ 0402) and 1210 and bigger (≥ 1210) is suitable for reflow soldering.

Application

- Automotive Electronic Equipment
(Powertrain, Safety, Body & Chassis, Convenience, Infotainment)

Structure and Dimensions

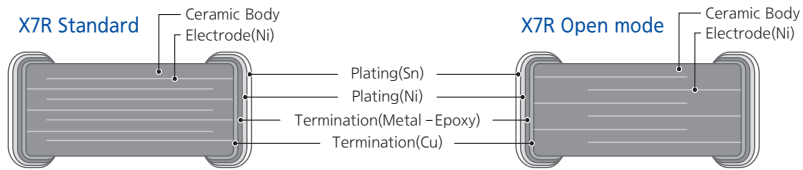
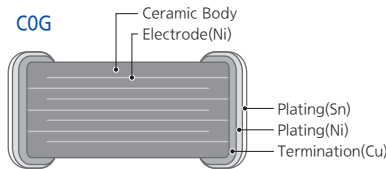
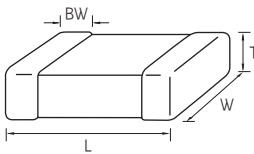

Size Code	EIA Code	Dimension(mm)				
		L	W	T	Thickness Code	BW
05	0402	1.00±0.05	0.50±0.05	0.50±0.05	5	0.25±0.10
10	0603	1.60±0.10	0.80±0.10	0.80±0.10	8	0.30±0.20
21	0805	2.00±0.10	1.25±0.10	0.60±0.10	6	0.50+0.20/-0.30
				0.85±0.10	C	
				1.25±0.10	F	
31	1206	3.20±0.15	1.60±0.15	1.25±0.15	Q	0.50±0.30
				0.85±0.15	C	
				1.15±0.10	P	
32	1210	3.20±0.30	2.50±0.20	1.60±0.20	H	0.60±0.30
				2.00±0.20	I	
				2.50±0.20	J	

Automotive Capacitance Table (COG)

Size inch (mm)	Thickness (mm)	Rated Voltage (Vdc)	Capacitance											
			pF					nF						
			10	22	47	100	220	470	1.0	2.2	4.7	10	22	
0402 (1005)	0.50	50												
		100												
0603 (1608)	0.80	50												
		100					270							
0805 (2012)	0.60 0.85 1.25	50												
		100												

Automotive Capacitance Table (X7R)

Size inch (mm)	Thickness (mm)	Rated Voltage (Vdc)	Capacitance											
			nF						uF					
			10	22	47	100	220	470	1.0	2.2	4.7	10	22	
0402 (1005)	0.50	10	█											
		16	█											
		25	█											
		50	█											
0603 (1608)	0.80	10	█						█					
		16	█						█					
		25	█											
		50	█											
		100	█											
0805 (2012)	1.25	10					█	█	█	█				
	0.85	16			█	█								
	1.25					█	█	█	█					
	0.60	25	█	█										
	0.85				█	█								
	1.25					█	█	█	█					
	0.60	50	█	█										
	0.85				█	█								
	1.25					█	█	█	█					
	0.60				█	█								
	0.85	100			█	█								
	1.25					█	█							
1206 (3216)	1.60	10							█	█	█	█		
	1.15	16							█					
	1.60								█	█	█	█		
	0.85	25				█	█							
	1.15								█					
	1.60								█	█	█	█		
	0.85	50				█	█							
	1.15						█	█						
	1.60							█	█	█	█			
	0.85					█	█							
	1.15	100				█	█							
1.60							█	█	█	█				
1210 (3225)	2.50	10										█		
	2.50	16										█		
	2.50	25							█	█				
	2.50	50							█	█				

General Automotive Capacitors

Product Line Up (Automotive Capacitors – COG)

■ Size : 1.00 X 0.50mm (inch : 0402)

Thickness Max.	Rated Voltage	Capacitance	Capacitance Tolerance	Part Number
0.55mm	50Vdc	4.7pF	±0.25pF	CL05C4R7CB51PN□
		6.8pF	±0.5pF	CL05C6R8DB51PN□
		10pF	±5%	CL05C100JB51PN□
		12pF	±5%	CL05C120JB51PN□
		15pF	±5%	CL05C150JB51PN□
		18pF	±5%	CL05C180JB51PN□
		22pF	±5%	CL05C220JB51PN□
		33pF	±5%	CL05C330JB51PN□
		39pF	±5%	CL05C390JB51PN□
		47pF	±5%	CL05C470JB51PN□
		56pF	±5%	CL05C560JB51PN□
		68pF	±5%	CL05C680JB51PN□
		82pF	±5%	CL05C820JB51PN□
		100pF	±5%	CL05C101JB51PN□
		120pF	±5%	CL05C121JB51PN□
		150pF	±5%	CL05C151JB51PN□
		180pF	±5%	CL05C181JB51PN□
		220pF	±5%	CL05C221JB51PN□
	100Vdc	4.7pF	±0.25pF	CL05C4R7CC51PN□
		6.8pF	±0.5pF	CL05C6R8DC51PN□
		10pF	±5%	CL05C100JC51PN□
		12pF	±5%	CL05C120JC51PN□
15pF		±5%	CL05C150JC51PN□	
18pF		±5%	CL05C180JC51PN□	
22pF		±5%	CL05C220JC51PN□	
27pF		±5%	CL05C270JC51PN□	
33pF		±5%	CL05C330JC51PN□	
39pF		±5%	CL05C390JC51PN□	
47pF	±5%	CL05C470JC51PN□		
56pF	±5%	CL05C560JC51PN□		
68pF	±5%	CL05C680JC51PN□		
82pF	±5%	CL05C820JC51PN□		
100pF	±5%	CL05C101JC51PN□		

■ Size : 1.60 X 0.80mm (inch : 0603)

Thickness Max.	Rated Voltage	Capacitance	Capacitance Tolerance	Part Number	
0.90mm	50Vdc	4.7pF	±0.25pF	CL10C4R7CB81PN□	
		6.8pF	±0.5pF	CL10C6R8DB81PN□	
		10pF	±5%	CL10C100JB81PN□	
		12pF	±5%	CL10C120JB81PN□	
		15pF	±5%	CL10C150JB81PN□	
		18pF	±5%	CL10C180JB81PN□	
		22pF	±5%	CL10C220JB81PN□	
		27pF	±5%	CL10C270JB81PN□	
		33pF	±5%	CL10C330JB81PN□	
		39pF	±5%	CL10C390JB81PN□	
		47pF	±5%	CL10C470JB81PN□	
		56pF	±5%	CL10C560JB81PN□	
		68pF	±5%	CL10C680JB81PN□	
		82pF	±5%	CL10C820JB81PN□	
		100pF	±5%	CL10C101JB81PN□	
		120pF	±5%	CL10C121JB81PN□	
		150pF	±5%	CL10C151JB81PN□	
		180pF	±5%	CL10C181JB81PN□	
		220pF	±5%	CL10C221JB81PN□	
		100Vdc	270pF	±5%	CL10C271JB81PN□
			330pF	±5%	CL10C331JB81PN□
			390pF	±5%	CL10C391JB81PN□
	470pF		±5%	CL10C471JB81PN□	
	560pF		±5%	CL10C561JB81PN□	
	680pF		±5%	CL10C681JB81PN□	
	820pF		±5%	CL10C821JB81PN□	
	1.0nF		±5%	CL10C102JB81PN□	
	100Vdc		4.7pF	±0.25pF	CL10C4R7CC81PN□
			6.8pF	±0.5pF	CL10C6R8DC81PN□
			10pF	±5%	CL10C100JC81PN□
			12pF	±5%	CL10C120JC81PN□
			15pF	±5%	CL10C150JC81PN□
			18pF	±5%	CL10C180JC81PN□
			22pF	±5%	CL10C220JC81PN□
			27pF	±5%	CL10C270JC81PN□
			33pF	±5%	CL10C330JC81PN□
			39pF	±5%	CL10C390JC81PN□
	47pF		±5%	CL10C470JC81PN□	
	56pF		±5%	CL10C560JC81PN□	
	68pF	±5%	CL10C680JC81PN□		
	82pF	±5%	CL10C820JC81PN□		
	100pF	±5%	CL10C101JC81PN□		
120pF	±5%	CL10C121JC81PN□			
150pF	±5%	CL10C151JC81PN□			
180pF	±5%	CL10C181JC81PN□			
220pF	±5%	CL10C221JC81PN□			

※ □ mark means packaging code. If you want to learn the code or quantity in detail, please see p.148

In order to move to the page directly, please click the here. ↑

Product Line Up (Automotive Capacitors – COG)

■ Size : 2.00 X 1.25mm (inch : 0805)

Thickness Max.	Rated Voltage	Capacitance	Capacitance Tolerance	Part Number	Thickness Max.	Rated Voltage	Capacitance	Capacitance Tolerance	Part Number		
0.70mm	50Vdc	10pF	±5%	CL21C100JB61PN□	0.95mm	100Vdc	470pF	±5%	CL21C471JCC1PN□		
		12pF	±5%	CL21C120JB61PN□			560pF	±5%	CL21C561JCC1PN□		
		15pF	±5%	CL21C150JB61PN□			680pF	±5%	CL21C681JCC1PN□		
		18pF	±5%	CL21C180JB61PN□			820pF	±5%	CL21C821JCC1PN□		
		22pF	±5%	CL21C220JB61PN□			1.0nF	±5%	CL21C102JCC1PN□		
		27pF	±5%	CL21C270JB61PN□			1.35mm	50Vdc	1.0nF	±5%	CL21C102JBF1PN□
		33pF	±5%	CL21C330JB61PN□					1.2nF	±5%	CL21C122JBF1PN□
		39pF	±5%	CL21C390JB61PN□					1.5nF	±5%	CL21C152JBF1PN□
		47pF	±5%	CL21C470JB61PN□					1.8nF	±5%	CL21C182JBF1PN□
		56pF	±5%	CL21C560JB61PN□					2.2nF	±5%	CL21C222JBF1PN□
		68pF	±5%	CL21C680JB61PN□	2.7nF	±5%			CL21C272JBF1PN□		
		82pF	±5%	CL21C820JB61PN□	3.3nF	±5%			CL21C332JBF1PN□		
		100pF	±5%	CL21C101JB61PN□	3.9nF	±5%			CL21C392JBF1PN□		
		120pF	±5%	CL21C121JB61PN□	4.7nF	±5%			CL21C472JBF1PN□		
		150pF	±5%	CL21C151JB61PN□	5.6nF	±5%			CL21C562JBF1PN□		
		180pF	±5%	CL21C181JB61PN□	6.8nF	±5%	CL21C682JBF1PN□				
		220pF	±5%	CL21C221JB61PN□	8.2nF	±5%	CL21C822JBF1PN□				
		270pF	±5%	CL21C271JB61PN□	10nF	±5%	CL21C103JBF1PN□				
		330pF	±5%	CL21C331JB61PN□	100Vdc	1.0nF	±5%	CL21C102JCF1PN□			
		390pF	±5%	CL21C391JB61PN□							
		100Vdc	10pF	±5%	CL21C100JC61PN□						
			12pF	±5%	CL21C120JC61PN□						
			15pF	±5%	CL21C150JC61PN□						
			18pF	±5%	CL21C180JC61PN□						
			22pF	±5%	CL21C220JC61PN□						
			27pF	±5%	CL21C270JC61PN□						
			33pF	±5%	CL21C330JC61PN□						
			39pF	±5%	CL21C390JC61PN□						
			47pF	±5%	CL21C470JC61PN□						
			56pF	±5%	CL21C560JC61PN□						
			68pF	±5%	CL21C680JC61PN□						
			82pF	±5%	CL21C820JC61PN□						
			100pF	±5%	CL21C101JC61PN□						
		120pF	±5%	CL21C121JC61PN□							
		150pF	±5%	CL21C151JC61PN□							
		180pF	±5%	CL21C181JC61PN□							
		220pF	±5%	CL21C221JC61PN□							
		270pF	±5%	CL21C271JC61PN□							
		330pF	±5%	CL21C331JC61PN□							
		390pF	±5%	CL21C391JC61PN□							
	0.95mm	50Vdc	470pF	±5%	CL21C471JBC1PN□						
			560pF	±5%	CL21C561JBC1PN□						
680pF			±5%	CL21C681JBC1PN□							
820pF			±5%	CL21C821JBC1PN□							
1.0nF			±5%	CL21C102JBC1PN□							
1.2nF			±5%	CL21C122JBC1PN□							
1.5nF			±5%	CL21C152JBC1PN□							
1.8nF			±5%	CL21C182JBC1PN□							
2.2nF			±5%	CL21C222JBC1PN□							
2.7nF			±5%	CL21C272JBC1PN□							
3.3nF			±5%	CL21C332JBC1PN□							
3.9nF			±5%	CL21C392JBC1PN□							
4.7nF			±5%	CL21C472JBC1PN□							
5.6nF	±5%	CL21C562JBC1PN□									

※ □ mark means packaging code. If you want to learn the code or quantity in detail, please see p.148

In order to move to the page directly, please click the here. ↑

General Automotive Capacitors

Product Line Up (Automotive Capacitors – X7R)

■ Size : 1.00 X 0.50mm (inch : 0402)

Thickness Max.	Rated Voltage	Capacitance	Capacitance Tolerance	Part Number	
0.55mm	10Vdc	100nF	±10%	CL05B104KP5VPN□	
		16Vdc	1.0nF	±10%	CL05B102K05VPN□
			1.5nF	±10%	CL05B152K05VPN□
			2.2nF	±10%	CL05B222K05VPN□
			3.3nF	±10%	CL05B332K05VPN□
			4.7nF	±10%	CL05B472K05VPN□
			6.8nF	±10%	CL05B682K05VPN□
			10nF	±10%	CL05B103K05VPN□
			15nF	±10%	CL05B153K05VPN□
			22nF	±10%	CL05B223K05VPN□
			33nF	±10%	CL05B333K05VPN□
			47nF	±10%	CL05B473K05VPN□
			68nF	±10%	CL05B683K05VPN□
			100nF	±10%	CL05B104K05VPN□
	25Vdc	1.0nF	±10%	CL05B102KA5VPN□	
		1.5nF	±10%	CL05B152KA5VPN□	
		2.2nF	±10%	CL05B222KA5VPN□	
		3.3nF	±10%	CL05B332KA5VPN□	
		4.7nF	±10%	CL05B472KA5VPN□	
		6.8nF	±10%	CL05B682KA5VPN□	
		10nF	±10%	CL05B103KA5VPN□	
		15nF	±10%	CL05B153KA5VPN□	
		22nF	±10%	CL05B223KA5VPN□	
		33nF	±10%	CL05B333KA5VPN□	
		47nF	±10%	CL05B473KA5VPN□	
		50Vdc	330pF	±10%	CL05B331KB5VPN□
			470pF	±10%	CL05B471KB5VPN□
			560pF	±10%	CL05B561KB5VPN□
	680pF		±10%	CL05B681KB5VPN□	
	1.0nF		±10%	CL05B102KB5VPN□	
	1.5nF		±10%	CL05B152KB5VPN□	
	2.2nF		±10%	CL05B222KB5VPN□	
	3.3nF		±10%	CL05B332KB5VPN□	
	4.7nF		±10%	CL05B472KB5VPN□	
	6.8nF		±10%	CL05B682KB5VPN□	
	10nF		±10%	CL05B103KB5VPN□	
	15nF		±10%	CL05B153KB5VPN□	
	22nF		±10%	CL05B223KB5VPN□	
	33nF		±10%	CL05B333KB5VPN□	
	47nF	±10%	CL05B473KB5VPN□		

■ Size : 1.60 X 0.80mm (inch : 0603)

Thickness Max.	Rated Voltage	Capacitance	Capacitance Tolerance	Part Number		
0.90mm	10Vdc	1.0uF	±10%	CL10B105KP8VPN□		
		16Vdc	47nF	±10%	CL10B473K08WPN□	
			68nF	±10%	CL10B683K08WPN□	
			100nF	±10%	CL10B104K08WPN□	
			150nF	±10%	CL10B154K08WPN□	
			220nF	±10%	CL10B224K08WPN□	
			330nF	±10%	CL10B334K08WPN□	
			470nF	±10%	CL10B474K08WPN□	
			680nF	±10%	CL10B684K08WPN□	
			1.0uF	±10%	CL10B105K08WPN□	
			25Vdc	1.0nF	±10%	CL10B102KA8WPN□
				1.5nF	±10%	CL10B152KA8WPN□
				2.2nF	±10%	CL10B222KA8WPN□
				3.3nF	±10%	CL10B332KA8WPN□
	4.7nF	±10%		CL10B472KA8WPN□		
	6.8nF	±10%		CL10B682KA8WPN□		
	10nF	±10%		CL10B103KA8WPN□		
	15nF	±10%		CL10B153KA8WPN□		
	22nF	±10%		CL10B223KA8WPN□		
	33nF	±10%		CL10B333KA8WPN□		
	47nF	±10%		CL10B473KA8WPN□		
	68nF	±10%		CL10B683KA8WPN□		
	100nF	±10%		CL10B104KA8WPN□		
	150nF	±10%		CL10B154KA8WPN□		
	220nF	±10%	CL10B224KA8WPN□			
	330nF	±10%	CL10B334KA8WPN□			
	470nF	±10%	CL10B474KA8WPN□			
	50Vdc	470pF	±10%	CL10B471KB8WPN□		
		1.0nF	±10%	CL10B102KB8WPN□		
		1.5nF	±10%	CL10B152KB8WPN□		
		2.2nF	±10%	CL10B222KB8WPN□		
		3.3nF	±10%	CL10B332KB8WPN□		
		4.7nF	±10%	CL10B472KB8WPN□		
		6.8nF	±10%	CL10B682KB8WPN□		
		10nF	±10%	CL10B103KB8WPN□		
		15nF	±10%	CL10B153KB8WPN□		
		22nF	±10%	CL10B223KB8WPN□		
		33nF	±10%	CL10B333KB8WPN□		
		47nF	±10%	CL10B473KB8WPN□		
		68nF	±10%	CL10B683KB8WPN□		
		100nF	±10%	CL10B104KB8WPN□		
	150nF	±10%	CL10B154KB8WPN□			
	220nF	±10%	CL10B224KB8WPN□			
	100Vdc	220pF	±10%	CL10B221KC8WPN□		
		330pF	±10%	CL10B331KC8WPN□		
		470pF	±10%	CL10B471KC8WPN□		
		680pF	±10%	CL10B681KC8WPN□		
		1.0nF	±10%	CL10B102KC8WPN□		
		1.5nF	±10%	CL10B152KC8WPN□		

※ □ mark means packaging code. If you want to learn the code or quantity in detail, please see p.148
 In order to move to the page directly, please click the here. †

Product Line Up (Automotive Capacitors – X7R)

■ Size : 1.60 X 0.80mm (inch : 0603)

Thickness Max.	Rated Voltage	Capacitance	Capacitance Tolerance	Part Number
0.90mm	100Vdc	2.2nF	±10%	CL10B222KC8WPN□
		3.3nF	±10%	CL10B332KC8WPN□
		4.7nF	±10%	CL10B472KC8WPN□
		6.8nF	±10%	CL10B682KC8WPN□
		10nF	±10%	CL10B103KC8WPN□
		15nF	±10%	CL10B153KC8WPN□
		22nF	±10%	CL10B223KC8WPN□
		33nF	±10%	CL10B333KC8WPN□
		47nF	±10%	CL10B473KC8WPN□

Thickness Max.	Rated Voltage	Capacitance	Capacitance Tolerance	Part Number	
0.90mm	50Vdc	100nF	±10%	CL21B104KBFVPN□	
		150nF	±10%	CL21B154KBFVPN□	
		220nF	±10%	CL21B224KBFVPN□	
		330nF	±10%	CL21B334KBFVPN□	
		470nF	±10%	CL21B474KBFVPN□	
		680nF	±10%	CL21B684KBFVPN□	
		1.0uF	±10%	CL21B105KBFVPN□	
		100Vdc	100nF	±10%	CL21B104KCFWPN□
	1.40mm	10Vdc	4.7uF	±10%	CL21B475KPQVPN□
		16Vdc	4.7uF	±10%	CL21B475KQVPN□

■ Size : 2.00 X 1.25mm (inch : 0805)

Thickness Max.	Rated Voltage	Capacitance	Capacitance Tolerance	Part Number		
0.70mm	50Vdc	1.0nF	±10%	CL21B102KB6WPN□		
		2.2nF	±10%	CL21B222KB6WPN□		
		4.7nF	±10%	CL21B472KB6WPN□		
		10nF	±10%	CL21B103KB6WPN□		
		15nF	±10%	CL21B153KB6WPN□		
		22nF	±10%	CL21B223KB6WPN□		
	100Vdc	1.0nF	±10%	CL21B102KC6WPN□		
		2.2nF	±10%	CL21B222KC6WPN□		
		4.7nF	±10%	CL21B472KC6WPN□		
		10nF	±10%	CL21B103KC6WPN□		
		15nF	±10%	CL21B153KC6WPN□		
		22nF	±10%	CL21B223KC6WPN□		
	0.95mm	16Vdc	100nF	±10%	CL21B104KOCWPN□	
			25Vdc	47nF	±10%	CL21B473KACWPN□
				68nF	±10%	CL21B683KACWPN□
				100nF	±10%	CL21B104KACWPN□
		50Vdc	33nF	±10%	CL21B333KBCWPN□	
			47nF	±10%	CL21B473KBCWPN□	
68nF			±10%	CL21B683KBCWPN□		
100nF			±10%	CL21B104KBCWPN□		
100Vdc		33nF	±10%	CL21B333KCCWPN□		
		47nF	±10%	CL21B473KCCWPN□		
		68nF	±10%	CL21B683KCCWPN□		
		100nF	±10%	CL21B104KCCWPN□		
1.35mm	10Vdc	1.0uF	±10%	CL21B105KPFVPN□		
		2.2uF	±10%	CL21B225KPFVPN□		
		16Vdc	150nF	±10%	CL21B154KOFVPN□	
			220nF	±10%	CL21B224KOFVPN□	
			330nF	±10%	CL21B334KOFVPN□	
			470nF	±10%	CL21B474KOFVPN□	
	680nF		±10%	CL21B684KOFVPN□		
	1.0uF		±10%	CL21B105KOFVPN□		
	25Vdc	2.2uF	±10%	CL21B225KOFVPN□		
		150nF	±10%	CL21B154KAFVPN□		
		220nF	±10%	CL21B224KAFVPN□		
		330nF	±10%	CL21B334KAFVPN□		
		470nF	±10%	CL21B474KAFVPN□		
		680nF	±10%	CL21B684KAFVPN□		
	1.35mm	16Vdc	1.0uF	±10%	CL21B105KBHVPN□	
			2.2uF	±10%	CL21B225KBHVPN□	
			150nF	±10%	CL21B154KBHVPN□	
			220nF	±10%	CL21B224KBHVPN□	
330nF			±10%	CL21B334KBHVPN□		
470nF			±10%	CL21B474KBHVPN□		
1.35mm	25Vdc	150nF	±10%	CL21B154KAFVPN□		
		220nF	±10%	CL21B224KAFVPN□		
		330nF	±10%	CL21B334KAFVPN□		
		470nF	±10%	CL21B474KAFVPN□		
		680nF	±10%	CL21B684KAFVPN□		
		1.0uF	±10%	CL21B105KAFVPN□		
1.35mm	25Vdc	2.2uF	±10%	CL21B225KAFVPN□		

■ Size : 3.20 X 1.60mm (inch : 1206)

Thickness Max.	Rated Voltage	Capacitance	Capacitance Tolerance	Part Number	
1.00mm	25Vdc	220nF	±10%	CL31B224KACWPN□	
		330nF	±10%	CL31B334KACWPN□	
		470nF	±10%	CL31B474KACWPN□	
	50Vdc	100nF	±10%	CL31B104KBCWPN□	
		100Vdc	100nF	±10%	CL31B104KCCWPN□
			100nF	±10%	CL31B104KOCWPN□
1.25mm	16Vdc	1.0uF	±10%	CL31B105KOPVPN□	
		25Vdc	680nF	±10%	CL31B684KAPVPN□
			1.0uF	±10%	CL31B105KAPVPN□
	50Vdc	100nF	±10%	CL31B104KBPVPN□	
		150nF	±10%	CL31B154KBPVPN□	
		220nF	±10%	CL31B224KBPVPN□	
		100Vdc	100nF	±10%	CL31B104KCPVPN□
			150nF	±10%	CL31B154KCPVPN□
			220nF	±10%	CL31B224KCPVPN□
	1.80mm	10Vdc	4.7uF	±10%	CL31B475KPHVPN□
			10uF	±10%	CL31B106KPHVPN□
			16Vdc	2.2uF	±10%
4.7uF		±10%		CL31B475KOHVPN□	
10uF		±10%		CL31B106KOHVPN□	
25Vdc		2.2uF	±10%	CL31B225KAHVPN□	
		4.7uF	±10%	CL31B475KAHVPN□	
		10uF	±10%	CL31B106KAHVPN□	
		50Vdc	330nF	±10%	CL31B334KBHVPN□
			470nF	±10%	CL31B474KBHVPN□
			680nF	±10%	CL31B684KBHVPN□
1.80mm		10Vdc	1.0uF	±10%	CL31B105KBHVPN□
			2.2uF	±10%	CL31B225KBHVPN□
			4.7uF	±10%	CL31B475KBHVPN□

■ Size : 3.20 X 2.50mm (inch : 1210)

Thickness Max.	Rated Voltage	Capacitance	Capacitance Tolerance	Part Number
2.70mm	10Vdc	22uF	±10%	CL32B226KPIVPN□
	16Vdc	22uF	±10%	CL32B226KOI VPN□
	25Vdc	4.7uF	±10%	CL32B475KAJVPN□
	50Vdc	4.7uF	±10%	CL32B475KJVPN□

※ □ mark means packaging code. If you want to learn the code or quantity in detail, please see p.148
In order to move to the page directly, please click the here. ↑

Feature

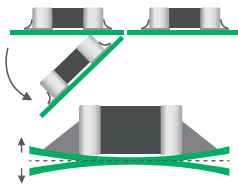

- AEC – Q200 qualified, 5mm bending strength guarantee.
- Strong thermal – mechanical properties.

Application

- Critical circuits and Battery line circuits.
(Prevent a module /sub – system failure in the event of a cracked /shorted capacitor)

Structure and Dimensions

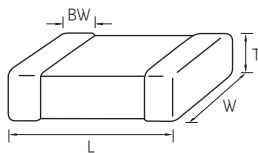

Standard Design VPJ

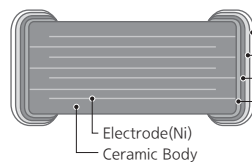

Open mode Design WPJ

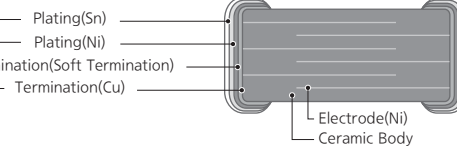

Size Code	EIA Code	Dimension(mm)				
		L	W	T	Thickness Code	BW
05	0402	1.00±0.10	0.50±0.05	0.50±0.05	5	0.25±0.10
10	0603	1.60±0.20	0.80±0.10	0.80±0.10	8	0.30±0.20
21	0805	2.00±0.30	1.25±0.20	0.85±0.10	C	0.50+0.20/-0.30
				1.25±0.20	F	
31	1206	3.20±0.30	1.60±0.30	1.60±0.30	H	0.50±0.30
32	1210	3.20±0.40	2.50±0.30	2.50±0.30	J	0.60±0.30

Higher Bending Strength Capacitance Table (X7R)

Size inch (mm)	Thickness (mm)	Rated Voltage (Vdc)	Capacitance											
			nF					uF						
			10	22	47	100	220	470	1.0	2.2	4.7	10	22	
0402 (1005)	0.50	16												
		50												
0603(1608)	0.80	25												
0805(2012)	1.25	25												
1206(3216)	1.60	16												

Product Line Up (Higher Bending Strength Capacitors – X7R)

■ Size : 1.00 X 0.50mm (inch : 0402)

Thickness Max.	Rated Voltage	Capacitance	Capacitance Tolerance	Part Number
0.55mm	16Vdc	10nF	±10%	CL05B103K05VPJ□
		22nF	±10%	CL05B223K05VPJ□
		47nF	±10%	CL05B473K05VPJ□
		100nF	±10%	CL05B104K05VPJ□
	25Vdc	10nF	±10%	CL05B103KA5VPJ□
		22nF	±10%	CL05B223KA5VPJ□
	50Vdc	10nF	±10%	CL05B103KB5VPJ□
		22nF	±10%	CL05B223KB5VPJ□

■ Size : 1.60 X 0.80mm (inch : 0603)

Thickness Max.	Rated Voltage	Capacitance	Capacitance Tolerance	Part Number
0.90mm	10Vdc	1.0uF	±10%	CL10B105KP8VPJ□
	16Vdc	1.0uF	±10%	CL10B105K08VPJ□
	25Vdc	1.0uF	±10%	CL10B105KA8VPJ□

■ Size : 2.00 X 1.25mm (inch : 0805)

Thickness Max.	Rated Voltage	Capacitance	Capacitance Tolerance	Part Number
1.45mm	10Vdc	1.0uF	±10%	CL21B105KPFVVPJ□
	16Vdc	1.0uF	±10%	CL21B105KOFVVPJ□
	25Vdc	1.0uF	±10%	CL21B105KAFVVPJ□

■ Size : 3.20 X 1.60mm (inch : 1206)

Thickness Max.	Rated Voltage	Capacitance	Capacitance Tolerance	Part Number
1.90mm	10Vdc	4.7uF	±10%	CL31B475KPHVPJ□
	16Vdc	4.7uF	±10%	CL31B475KOHVPJ□

※ □ mark means packaging code. If you want to learn the code or quantity in detail, please see p.148
In order to move to the page directly, please click the here. ↑

Feature

- Compliance with the IEC 61000 – 4 – 2 standard for ESD immunity.
- Enhanced DC – Bias & Breakdown voltage.

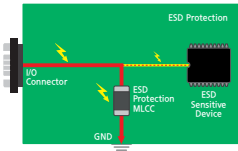

Application

- Input and output sections in a wide range of automotive electronics.

Structure and Dimensions

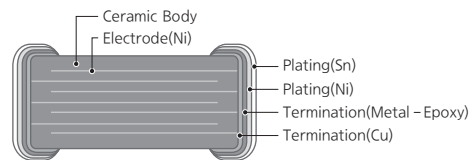
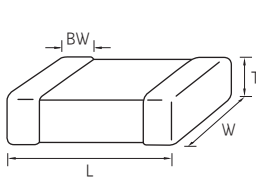

Size Code	EIA Code	Dimension(mm)			
		L	W	T	BW
10	0603	1.70±0.10	0.90±0.10	0.90±0.10	0.30±0.20

ESD Protection Capacitance Table (X7R)

Size inch (mm)	Thickness (mm)	Rated Voltage (Vdc)	Capacitance(nF)													
			1.0	1.5	2.2	3.3	4.7	6.8	10	15	22	33	47			
0603(1608)	0.80	100														

Product Lineup (ESD Protection Capacitors – X7R)

- Size : 1.70 X 0.90mm (inch : 0603)

Thickness Max.	Rated Voltage	Capacitance	Capacitance Tolerance	Part Number
1.00mm	100Vdc	1.0nF	±10%	CL10B102KC84PE □
		1.5nF	±10%	CL10B152KC84PE □
		2.2nF	±10%	CL10B222KC84PE □
		3.3nF	±10%	CL10B332KC84PE □
		4.7nF	±10%	CL10B472KC84PE □
		6.8nF	±10%	CL10B682KC84PE □
		10nF	±10%	CL10B103KC84PE □

※ □ mark means packaging code. If you want to learn the code or quantity in detail, please see p.148
 In order to move to the page directly, please click the here. ↑

Reliability Test Conditions

No.	Item	Performance	Test condition															
1	Pre-and Post-Stress Electrical Test	-																
2	High Temperature Exposure	Appearance	No abnormal exterior appearance															
		Capacitance Change	Class I	Within $\pm 2.5\%$ or $\pm 0.25\text{pF}$, (Whichever is larger)														
			Class II	Within $\pm 10\%$														
		Q	Class I	Capacitance $\geq 30\text{pF}$: $Q \geq 1,000$ $< 30\text{pF}$: $Q \geq 400 + 20 \times C$ (C : Capacitance)														
		Tan δ	Class II	Rated Voltage $\geq 25\text{V}$: 0.030 max $\geq 16\text{V}$: 0.050 max $\geq 10\text{V}$: 0.075 max *1)														
IR		More than $10,000\text{M}\Omega$ or $500\text{M}\Omega \times \mu\text{F}$ (Whichever is smaller) *1)																
3	Temperature Cycling	Appearance	No abnormal exterior appearance															
		Capacitance Change	Class I	Within $\pm 2.5\%$ or $\pm 0.25\text{pF}$, (Whichever is larger)														
			Class II	Within $\pm 10\%$														
		Q	Class I	Capacitance $\geq 30\text{pF}$: $Q \geq 1,000$ $< 30\text{pF}$: $Q \geq 400 + 20 \times C$ (C : Capacitance)														
		Tan δ	Class II	Rated Voltage $\geq 25\text{V}$: 0.030 max $\geq 16\text{V}$: 0.050 max $\geq 10\text{V}$: 0.075 max *1)														
IR		More than $10,000\text{M}\Omega$ or $500\text{M}\Omega \times \mu\text{F}$ (Whichever is smaller) *1)																
			<table border="1"> <thead> <tr> <th>Step</th> <th>Temperature(°C)</th> <th>Time(min.)</th> </tr> </thead> <tbody> <tr> <td>1</td> <td>Min. operating Temp.+0/-3</td> <td>30\pm3</td> </tr> <tr> <td>2</td> <td>25\pm2</td> <td>1</td> </tr> <tr> <td>3</td> <td>Max. operating Temp.+3/-0</td> <td>30\pm3</td> </tr> <tr> <td>4</td> <td>25\pm2</td> <td>1</td> </tr> </tbody> </table>	Step	Temperature(°C)	Time(min.)	1	Min. operating Temp.+0/-3	30 \pm 3	2	25 \pm 2	1	3	Max. operating Temp.+3/-0	30 \pm 3	4	25 \pm 2	1
Step	Temperature(°C)	Time(min.)																
1	Min. operating Temp.+0/-3	30 \pm 3																
2	25 \pm 2	1																
3	Max. operating Temp.+3/-0	30 \pm 3																
4	25 \pm 2	1																
4	Destructive Physical Analysis	No defects or abnormalities	Per EIA 469															
5	Biased Humidity	Appearance	No abnormal exterior appearance															
		Capacitance Change	Class I	Within $\pm 2.5\%$ or $\pm 0.25\text{pF}$, (Whichever is larger)														
			Class II	Within $\pm 12.5\%$														
		Q	Class I	Capacitance $\geq 30\text{pF}$: $Q \geq 200$ $< 30\text{pF}$: $Q \geq 100 + (10/3) \times C$ (C : Capacitance)														
		Tan δ	Class II	Rated Voltage $\geq 25\text{V}$: 0.035 max $\geq 16\text{V}$: 0.050 max $\geq 10\text{V}$: 0.075 max *1)														
IR		More than $500\text{M}\Omega$ or $25\text{M}\Omega \times \mu\text{F}$ (Whichever is smaller) *1)																
6	High Temperature Operating Life	Appearance	No abnormal exterior appearance															
		Capacitance Change	Class I	Within $\pm 3.0\%$ or $\pm 0.3\text{pF}$, (Whichever is larger)														
			Class II	Within $\pm 12.5\%$														
		Q	Class I	Capacitance $\geq 30\text{pF}$: $Q \geq 350$ $\geq 10\text{pF}$: $Q \geq 275 + (5/2) \times C$ $< 10\text{pF}$: $Q \geq 200 + 10 \times C$ (C : Capacitance)														
		Tan δ	Class II	Rated Voltage $\geq 25\text{V}$: 0.035 max $\geq 16\text{V}$: 0.050 max $\geq 10\text{V}$: 0.075 max *1)														
IR		More than $1,000\text{M}\Omega$ or $50\text{M}\Omega \times \mu\text{F}$ (Whichever is smaller) *1)																

※ *1) : Indicates typical specification. Please refer to individual specifications.
 ※ 2) : Some of the parts are applicable in rated voltage $\times 150\%$ or $\times 120\%$, Please refer to individual specifications.

Reliability Test Conditions

No.	Item	Performance	Test condition								
7	External Visual	No abnormal exterior appearance	Microscope (x10)								
8	Physical Dimensions	Within the specified dimensions	Using the calipers								
9	Mechanical Shock	Appearance	No abnormal exterior appearance								
		Capacitance Change	Class I	Within $\pm 2.5\%$ or $\pm 0.25\text{pF}$, (Whichever is larger)							
			Class II	Within $\pm 10\%$							
		Q	Class I	Capacitance $\geq 30\text{pF}$: $Q \geq 1,000$ $< 30\text{pF}$: $Q \geq 400 + 20 \times C$ (C : Capacitance)							
		Tan δ	Class II	Rated Voltage $\geq 25\text{V}$: 0.025 max $\geq 16\text{V}$: 0.035 max $\geq 10\text{V}$: 0.050 max *1)							
IR		More than 10,000M Ω or 500M Ω X μF (Whichever is smaller) *1)									
			Three shocks in each direction should be applied along 3 mutually perpendicular axes of the test specimen (18 shocks) <table border="1"> <thead> <tr> <th>Peak value</th> <th>Duration</th> <th>Wave</th> <th>Velocity</th> </tr> </thead> <tbody> <tr> <td>1,500G</td> <td>0.5ms</td> <td>Half sine</td> <td>4.7m / sec</td> </tr> </tbody> </table> <p>Initial Measurement Perform the heat treatment at 150°C +0/-10°C for 1 hour and leave the capacitor in ambient condition for 24±2 hours before measurement. Then perform the measurement.</p> <p>Final Measurement Leave the capacitor in ambient condition for 24±2 hours before measurement. Then perform the measurement.</p>	Peak value	Duration	Wave	Velocity	1,500G	0.5ms	Half sine	4.7m / sec
Peak value	Duration	Wave	Velocity								
1,500G	0.5ms	Half sine	4.7m / sec								
10	Vibration	Appearance	No abnormal exterior appearance								
		Capacitance Change	Class I	Within $\pm 2.5\%$ or $\pm 0.25\text{pF}$, (Whichever is larger)							
			Class II	Within $\pm 10\%$							
		Q	Class I	Capacitance $\geq 30\text{pF}$: $Q \geq 1,000$ $< 30\text{pF}$: $Q \geq 400 + 20 \times C$ (C : Capacitance)							
		Tan δ	Class II	Rated Voltage $\geq 25\text{V}$: 0.025 max $\geq 16\text{V}$: 0.035 max $\geq 10\text{V}$: 0.050 max *1)							
IR		More than 10,000M Ω or 500M Ω X μF (Whichever is smaller) *1)									
			5g's for 20min., 12cycles each of 3 orientations, Use 8" x 5" PCB 0.031" Thick 7 secure points on one long side and 2 secure points at corners of opposite sides. Parts mounted within 2" from any secure point. Test from 10~2000Hz. <p>Initial Measurement Perform the heat treatment at 150°C +0/-10°C for 1 hour and leave the capacitor in ambient condition for 24±2 hours before measurement. Then perform the measurement.</p> <p>Final Measurement Leave the capacitor in ambient condition for 24±2 hours before measurement. Then perform the measurement.</p>								
11	Resistance to Solder Heat	Appearance	No abnormal exterior appearance								
		Capacitance Change	Class I	Within $\pm 2.5\%$ or $\pm 0.25\text{pF}$, (Whichever is larger)							
			Class II	Within $\pm 10\%$							
		Q	Class I	Capacitance $\geq 30\text{pF}$: $Q \geq 1,000$ $< 30\text{pF}$: $Q \geq 400 + 20 \times C$ (C : Capacitance)							
		Tan δ	Class II	Rated Voltage $\geq 25\text{V}$: 0.025 max $\geq 16\text{V}$: 0.035 max $\geq 10\text{V}$: 0.050 max *1)							
IR		More than 10,000M Ω or 500M Ω X μF (Whichever is smaller) *1)									
			Solder pot : 260±5°C, 10±1sec. <p>Initial Measurement Perform the heat treatment at 150°C +0/-10°C for 1 hour and leave the capacitor in ambient condition for 24±2 hours before measurement. Then perform the measurement.</p> <p>Final Measurement Leave the capacitor in ambient condition for 24±2 hours before measurement. Then perform the measurement.</p>								
12	ESD	Appearance	No abnormal exterior appearance								
		Capacitance Change	Class I	Within $\pm 2.5\%$ or $\pm 0.25\text{pF}$, (Whichever is larger)							
			Class II	Within $\pm 10\%$							
		Q	Class I	Capacitance $\geq 30\text{pF}$: $Q \geq 1,000$ $< 30\text{pF}$: $Q \geq 400 + 20 \times C$ (C : Capacitance)							
		Tan δ	Class II	Rated Voltage $\geq 25\text{V}$: 0.025 max $\geq 16\text{V}$: 0.035 max $\geq 10\text{V}$: 0.050 max *1)							
IR		More than 10,000M Ω or 500M Ω X μF (Whichever is smaller) *1)									
			AEC - Q200 - 002 <p>Initial Measurement Perform the heat treatment at 150°C +0/-10°C for 1 hour and leave the capacitor in ambient condition for 24±2 hours before measurement. Then perform the measurement.</p> <p>Final Measurement Perform the heat treatment at 150°C +0/-10°C for 1 hour and leave the capacitor in ambient condition for 24±2 hours before measurement. Then perform the measurement.</p>								
13	Solderability	95% of the terminations is to be soldered evenly and continuously	a) Preheat at 155°C for 4 hrs, Immerse in solder for 5s at 235±5°C b) Steam aging for 8 hrs, Immerse in solder for 5s at 235±5°C c) Steam aging for 8 hrs, Immerse in solder for 120s at 260±5°C solder : a solution ethanol and rosin								

*1) : Indicates typical specification. Please refer to individual specifications.

No.	Item		Performance	Test condition																	
14	Electrical Characterization	Capacitance	Within specified tolerance	The Capacitance / D.F. should be measured at 25°C, * Capacitance shall be measured after the heat treatment of 150+0/-10°C for 1hr and leaving for 24±2hr at room temperature. (Class II) <table border="1" style="margin-top: 10px;"> <thead> <tr> <th>Class</th> <th>Capacitance</th> <th>Frequency</th> <th>Voltage</th> </tr> </thead> <tbody> <tr> <td rowspan="2">I</td> <td>1000pF ↓</td> <td>1MHz ±10%</td> <td rowspan="2">0.5 ~ 5.0Vrms</td> </tr> <tr> <td>1000pF ↑</td> <td>1kHz ±10%</td> </tr> <tr> <td rowspan="2">II</td> <td>10μF ↓</td> <td>1kHz ±10%</td> <td>1.0±0.2Vrms</td> </tr> <tr> <td>10μF ↑</td> <td>120Hz ±20%</td> <td>0.5±0.1Vrms</td> </tr> </tbody> </table>	Class	Capacitance	Frequency	Voltage	I	1000pF ↓	1MHz ±10%	0.5 ~ 5.0Vrms	1000pF ↑	1kHz ±10%	II	10μF ↓	1kHz ±10%	1.0±0.2Vrms	10μF ↑	120Hz ±20%	0.5±0.1Vrms
		Class	Capacitance		Frequency	Voltage															
		I	1000pF ↓		1MHz ±10%	0.5 ~ 5.0Vrms															
			1000pF ↑		1kHz ±10%																
		II	10μF ↓		1kHz ±10%	1.0±0.2Vrms															
			10μF ↑		120Hz ±20%	0.5±0.1Vrms															
		Q	Class I		Capacitance ≥ 30pF : Q ≥ 1,000 < 30pF : Q ≥ 400 + 20 X C (C : Capacitance)																
Tanδ	Class II	Rated Voltage ≥ 25V : 0.025 max ≥ 16V : 0.035 max ≥ 10V : 0.050 max *1)																			
IR@25°C	Class I	More than 100,000MΩ or 1,000MΩ X μF (Whichever is smaller)																			
	Class II	More than 10,000MΩ or 500MΩ X μF (Whichever is smaller)																			
IR@125°C	Class I	More than 10,000MΩ or 100MΩ X μF (Whichever is smaller)																			
	Class II	More than 1,000MΩ or 10MΩ X μF (Whichever is smaller)																			
Dielectric Strength		No dielectric breakdown or mechanical breakdown																			
15	Board Flex	Appearance	No abnormal exterior appearance	Bending to the limit for 60 seconds. Limit : Class I - 3mm Class II - 2mm *1) Initial Measurement Perform the heat treatment at 150°C +0/-10°C for 1 hour and leave the capacitor in ambient condition for 24±2 hours before measurement. Then perform the measurement. Final Measurement Leave the capacitor in ambient condition for 24±2 hours before measurement. Then perform the measurement.																	
		Capacitance Change	Class I		Within±5.0% or ±0.5pF, (Whichever is larger)																
			Class II		Within±10%																
16	Terminal Strength (SMD)	Appearance	No abnormal exterior appearance	18N, for 60±1 sec. * 0603(1608) -10N, 0402(1005) -2N Initial Measurement Perform the heat treatment at 150°C +0/-10°C for 1 hour and leave the capacitor in ambient condition for 24±2 hours before measurement. Then perform the measurement. Final Measurement Leave the capacitor in ambient condition for 24±2 hours before measurement. Then perform the measurement.																	
		Capacitance Change	Class I		Within±2.5% or ±0.25pF, (Whichever is larger)																
			Class II		Within±10%																
17	Beam Load		Destruction value should be exceed Chip Length ≤ 2.5mm a) Chip Thickness > 0.5mm : 20N b) Chip Thickness ≤ 0.5mm : 8N Chip Length ≥ 3.2mm a) Chip Thickness ≥ 1.25mm : 54.5N b) Chip Thickness < 1.25mm : 15N	Beam speed Chip Length ≤ 2.5mm, 0.50±0.05mm / sec. Chip Length ≥ 3.5mm, 2.50±0.25mm / sec.																	
18	Capacitance Temperature Characteristics	Capacitance Change	Class I	0±30ppm / °C	Capacitance shall be measured by the steps shown in the following table. <table border="1" style="margin-top: 10px;"> <thead> <tr> <th>Step</th> <th>Temperature(°C)</th> </tr> </thead> <tbody> <tr> <td>1</td> <td>25±2</td> </tr> <tr> <td>2</td> <td>Min. operating temp.±2</td> </tr> <tr> <td>3</td> <td>25±2</td> </tr> <tr> <td>4</td> <td>Max. operating temp.±2</td> </tr> <tr> <td>5</td> <td>25±2</td> </tr> </tbody> </table> <ul style="list-style-type: none"> ■ Class I Temperature Coefficient shall be calculated from the formula as below Temp. Coefficient = $\frac{C2 - C1}{C1 \times \Delta T} \times 10^6$ [ppm / °C] C1 : Capacitance at step 3 C2 : Capacitance at 125°C ΔT : 125°C - 25°C = 100°C ■ Class II Capacitance change shall be calculated from the formula as below ΔC = $\frac{C2 - C1}{C1} \times 100$ (%) C1 : Capacitance at step 3 C2 : Capacitance at step 2 or step 4 	Step	Temperature(°C)	1	25±2	2	Min. operating temp.±2	3	25±2	4	Max. operating temp.±2	5	25±2				
			Step	Temperature(°C)																	
1	25±2																				
2	Min. operating temp.±2																				
3	25±2																				
4	Max. operating temp.±2																				
5	25±2																				
Class II	Within±15%																				

※ *1) : Indicates typical specification. Please refer to individual specifications.
 If you want more detailed information, Please Visit Samsung Electro -mechanics website (www.semlcr.com)

Packaging Specifications

- Taping Packaging design : Packaging design follows IEC 60286 – 3 standard (IEC 60286 – 3 Packaging of components for automatic handling – parts 3)

Cardboard(Paper) tape : 4mm pitch

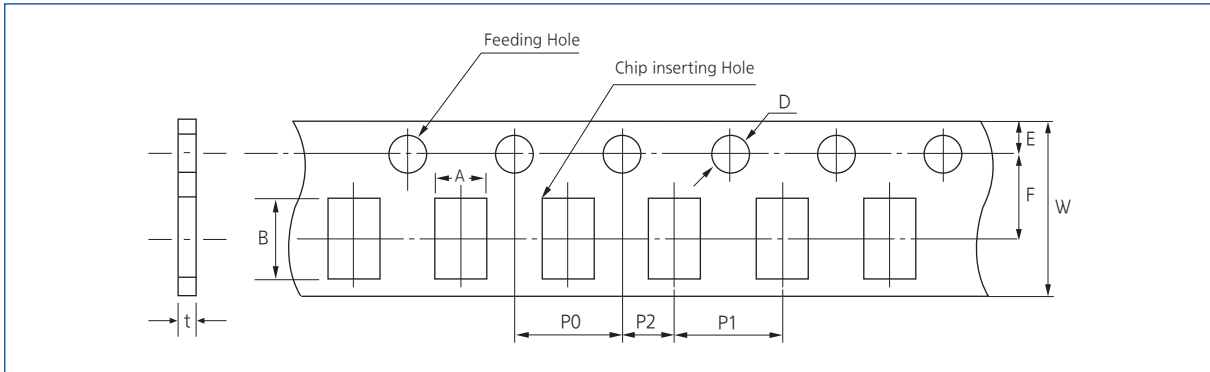

Unit : mm

Symbol		A	B	W	F	E	P1	P2	P0	D	t
Size inch(mm)	0504 (1410)	1.30 ±0.20	1.70 ±0.20	8.00 ±0.30	3.50 ±0.05	1.75 ±0.10	4.00 ±0.10	2.00 ±0.05	4.00 ±0.10	∅1.50 +0.10/-0	1.10 Below
	0603 0306 (1608) (0816)	1.10 ±0.20	1.90 ±0.20								
	0805 0508 (2012) (1220)	1.60 ±0.20	2.40 ±0.20								
	1206 0612 (3216) (1632)	2.00 ±0.20	3.60 ±0.20								

* According to normal size, we fill out A, B in the table above. The data may be changed as special size tolerance.

Cardboard(Paper) tape : 2mm pitch

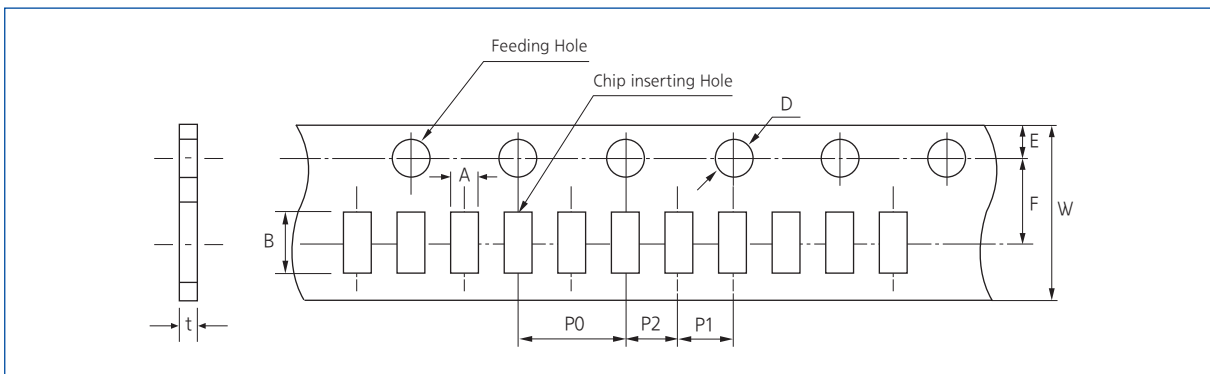

Unit : mm

Symbol		A	B	W	F	E	P1	P2	P0	D	t
Size inch(mm)	01005 (0402)	0.25 ±0.02	0.45 ±0.02	8.00 ±0.30	3.50 ±0.05	1.75 ±0.10	2.00 ±0.10	2.00 ±0.05	4.00 ±0.10	∅1.50 +0.10 /-0.03	0.25 ±0.02
	0201 (0603)	0.38 ±0.03	0.68 ±0.03								0.37 ±0.03
	0402 (1005)	0.62 ±0.05	1.12 ±0.05								0.37 ±0.05
											0.60 ±0.05
	0204 (0510)	0.62+0.05 /-0.10	1.12+0.05 /-0.10								0.37 ±0.03

* According to normal size, we fill out A, B in the table above. The data may be changed as special size tolerance.

Embossed(Plastic) tape

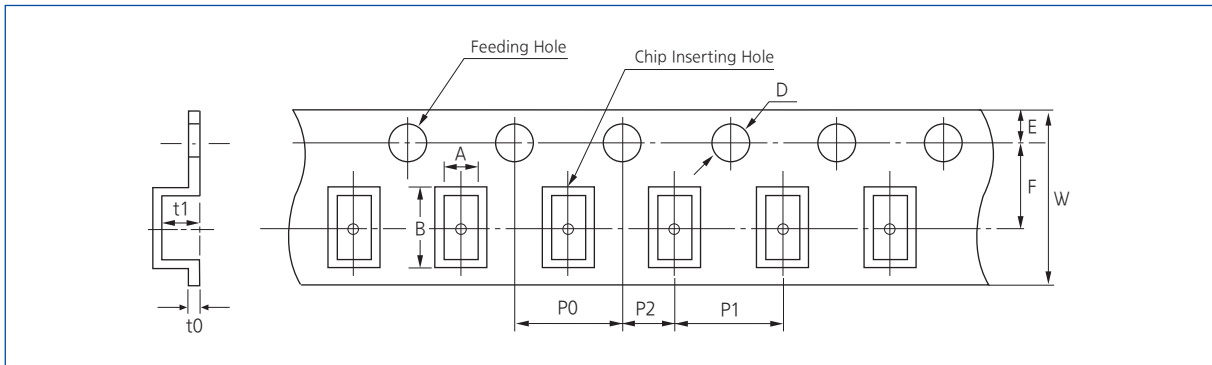

Unit : mm

Symbol Type	A	B	W	F	E	P1	P2	P0	D	t1	t0
01005 (0402)	0.25 ±0.02	0.45 ±0.02	4.00 ±0.05	1.80 ±0.02	0.90 ±0.05	1.00 ±0.02	1.00 ±0.02	2.00 ±0.04	∅0.80 ±0.04	0.25 ±0.02	0.50 Max
0603 (1608)	1.05 ±0.15	1.90 ±0.15	8.00 ±0.30	3.50 ±0.05	1.75 ±0.10	4.00 ±0.10	2.00 ±0.05	4.00 ±0.10	∅1.50 +0.10 /-0.03	2.90 Max	0.60 Below
0805 (2012)	1.45 ±0.20	2.30 ±0.20									
1206 (3216)	1.90 ±0.20	3.50 ±0.20									
1210 (3225)	2.80 ±0.20	3.60 ±0.20									
1808 (4520)	2.30 ±0.20	4.90 ±0.20	12.00 ±0.30	5.60 ±0.05	1.75 ±0.10	8.00 ±0.10	2.00 ±0.05	4.00 ±0.10	∅1.50 +0.10 /-0.03	3.80 Max	0.60 Below
1812 (4532)	3.60 ±0.20	4.90 ±0.20									
2220 (5750)	5.50 ±0.20	6.20 ±0.20									
0204 (5010)	0.62 +0.05 /-0.10	1.12 +0.05 /-0.10	0.80 ±0.30	3.50 ±0.05	1.75 ±0.10	4.00 ±0.10	2.00 ±0.05	4.00 ±0.10	∅1.50 +0.10 /-0.03	2.50 Max	0.60 Below
0306 (0816)	1.10 ±0.20	1.90 ±0.20									
0508 (1220)	1.45 ±0.20	2.30 ±0.20									
0612 (1632)	2.00 ±0.20	3.60 ±0.20									

* According to normal size, we fill out A, B in the table above. The data may be changed as special size tolerance.

Peeling off of Tape

■ $10g.f \leq \text{Peel off force} \leq 70g.f$

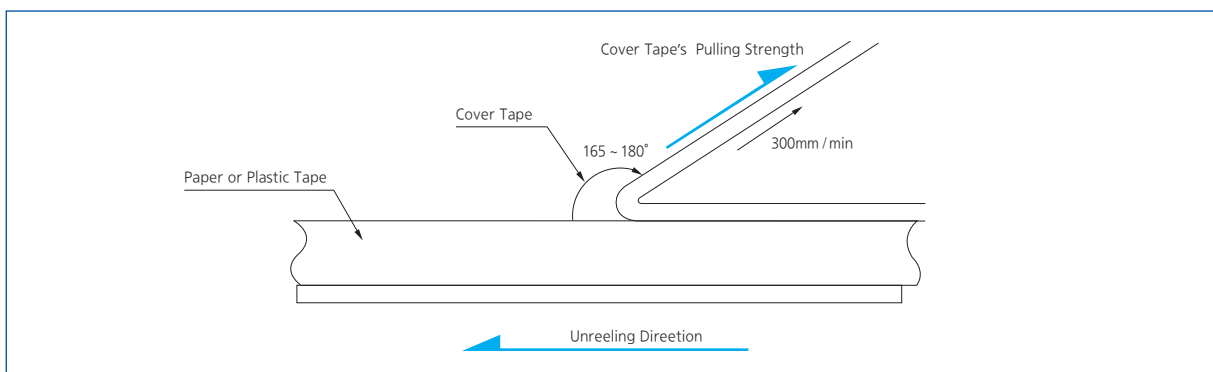

Packaging Specifications

Taping figure

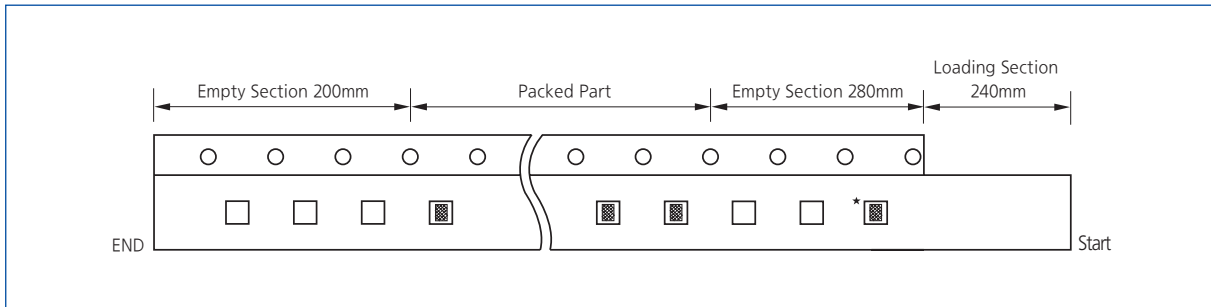

★The chip is only use for identifying the label and packaged products. Please don't use the chip.

Packaging Code & Quantity

Unit : kpcs

Size inch(mm)	Thickness code	Cardboard(Paper) Type											
		7" Reel					10" Reel	13" Reel					
		C	8	H	Z*	Y*	O	D	L	2*	7*	3	
01005(0402)	2	20	-	-	-	-	-	100	-	-	-	-	-
0201(0603)	3	10	-	15	10	10	30	50	-	150	50	-	
0402(1005)	3	10	-	15	-	-	30	50	-	-	-	-	
	5	10	8	-	10	10	30	50	40	100	50	-	
	7,8(THMC)	-	8	-	-	-	-	-	-	-	-	30	
0504(1410)	8	4	-	-	-	-	10	10	15	-	-	-	
	5	4	-	-	-	-	30	50	-	-	-	-	
0603(1608)	8	4	-	-	4	4	10	10	15	-	-	-	
	9,N	4	-	-	-	-	-	-	-	-	-	-	
0805(2012)	A,C	4	-	-	-	-	10	10	15	-	-	-	
1206(3216)	C	4	-	-	-	-	10	10	15	-	-	-	

* 2 = 1mm Pitch / Z = Chip aligned for horizontal / Y, 7 = Chip aligned for vertical

Unit : kpcs

Size inch(mm)	Thickness code	Embossed(Plastic) Type							Bulk case Type	Bulk Type
		7" Reel				10" Reel	13" Reel			
		E	G	W*	R*	S	F	P		
01005(0402)	2	50	-	-	-	-	-	-	-	-
0201(0603)	1	10	-	-	-	-	-	-	-	-
0402(1005)	1,2,L	15	-	-	-	-	-	-	-	-
	3,5	-	-	-	-	-	-	50	-	-
0603(1608)	8	3	-	-	3	-	10	15	-	-
	E,M	3	-	-	-	-	-	-	-	-
0604(1610)	D	3	-	3	-	6	10	-	-	-
	A,C	-	-	-	-	-	-	10	-	-
0805(2012)	E	2	3	2	-	6	10	5	-	-
	F	2	3	2	-	6	10	5	-	-
	Q	2	3	2	-	6	10	5	-	-
1206(3216)	E,P,F	2	3	-	-	6	10	-	-	-
	H	2	-	2	-	4	8	-	-	-
1210(3225)	9,D,C,O	2	-	-	-	-	10	-	-	-
	E,F,M	2	-	-	-	-	10	-	-	-
	H,T	2	-	-	-	4	8	-	-	-
	I,U	2	-	-	-	-	4	-	-	-
	J,V	1	-	1	-	-	4	-	-	-
	S	2	-	-	-	-	8	-	-	-
1808(4520)	F	2	-	-	-	-	-	-	-	-
1812(4532)	F	1	-	-	-	-	4	-	-	-
	H,I	1	-	-	-	-	4	-	-	-
	J,L	-	-	-	-	-	2	-	-	-
2220(5750)	H,I,J	-	-	-	-	-	2	-	-	-

* R = Chip aligned for horizontal / W = Chip aligned for vertical

Reel Dimensions

Unit : mm

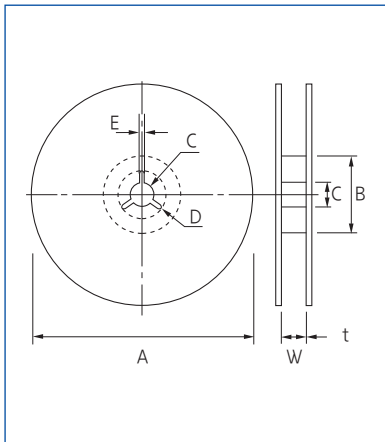

Symbol	Tape Width	A	B	C	D
7" Reel	4mm	$\varnothing 178 \pm 2.0$	MIN $\varnothing 50$	$\varnothing 13 \pm 0.5$	21 ± 0.8
	8mm	$\varnothing 178 \pm 2.0$	MIN $\varnothing 50$	$\varnothing 13 \pm 0.5$	21 ± 0.8
	12mm	$\varnothing 178 \pm 2.0$	MIN $\varnothing 50$	$\varnothing 13 \pm 0.5$	21 ± 0.8
10" Reel	8mm	$\varnothing 258 \pm 2.0$	MIN $\varnothing 70$	$\varnothing 13 \pm 0.5$	21 ± 0.8
13" Reel	8mm	$\varnothing 330 \pm 2.0$	MIN $\varnothing 70$	$\varnothing 13 \pm 0.5$	21 ± 0.8
	12mm	$\varnothing 330 \pm 2.0$	MIN $\varnothing 70$	$\varnothing 13 \pm 0.5$	21 ± 0.8

Symbol	Tape Width	E	W	t
7" Reel	4mm	2.0 ± 0.5	5.0 ± 0.5	1.2 ± 0.2
	8mm	2.0 ± 0.5	10 ± 1.5	0.9 ± 0.2
	12mm	2.0 ± 0.5	13 ± 0.5	1.2 ± 0.2
10" Reel	8mm	2.0 ± 0.5	10 ± 1.5	1.8 ± 0.2
13" Reel	8mm	2.0 ± 0.5	10 ± 1.5	1.8 ± 0.2
	12mm	2.0 ± 0.5	13 ± 0.5	2.2 ± 0.2

Bulk Case Packaging

- Bulk case packaging can reduce the stock space and transportation costs.
- The bulk feeding system can increase the productivity.
- It can eliminate the components loss.

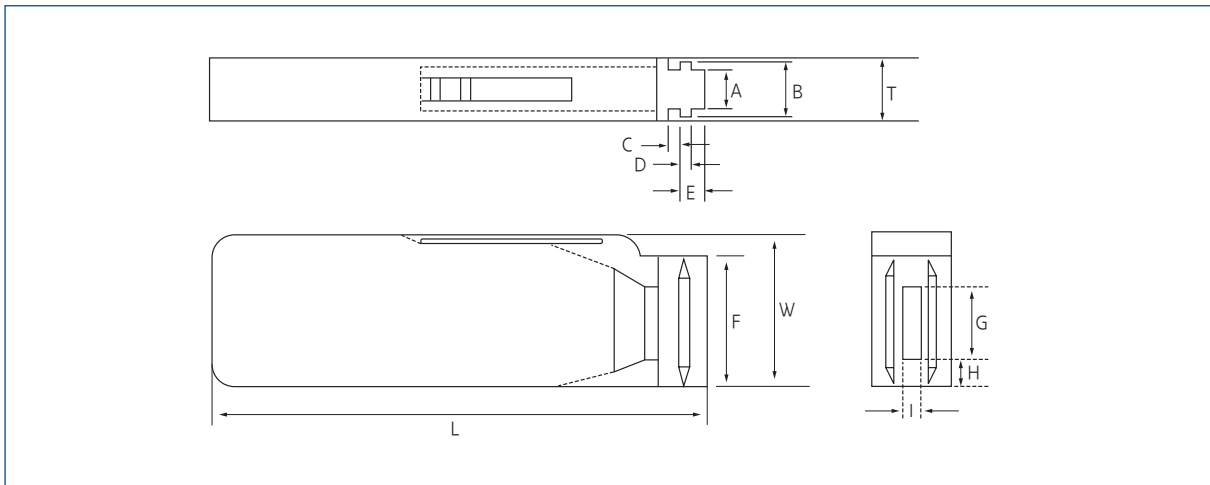

Unit : mm

Symbol	A	B	T	C	D	E
Dimension	6.80 ± 0.10	8.80 ± 0.10	12 ± 0.10	$1.50 \pm 0.10 / -0$	$2.00 +0 / -0.10$	$3.00 +0.20 / -0$

Symbol	F	W	G	H	L	I
Dimension	$31.5 +0.20 / -0$	$36 +0 / -0.20$	19 ± 0.35	7.00 ± 0.35	110 ± 0.70	5.00 ± 0.35

■ QUANTITY

Unit : pcs

Size Inch(mm)	0402(1005)	0603(1608)	0805(2012)	
			T ≤ 0.85mm	T ≥ 1.0mm
Quantity	50,000	10,000 or 15,000	10,000	5,000

Application Manual for Surface Mounting

1. Storage of products

1-1. Storage Environment

Tape packing materials are designed to withstand long-term storage, but they will degrade more rapidly in the presence of high temperature or high humidity. Therefore, the products must be stored in an ambient 0 ~ 40°C with a relative humidity of 0 ~ 70%. Allowable storage period is within 6 months from the outgoing date of delivery.

1-2. Corrosive Gases

Since sulfur and chlorine may degrade the solderability of the end termination, it is important to store the capacitors in an environment free of these gases.

1-3. Temperature Fluctuations

Since dew condensation may occur by the differences in temperature when the products are taken out of storage, it is important to maintain a temperature-controlled environment.

2. Design of Solder Land Pattern

When designing printed circuit boards, the shape and size of the solder lands must allow for the proper amount of solder on the capacitor. The amount of solder at the end terminations has a direct effect on the probability that the chip will crack. The greater amount of solder, the larger amount of stress on the chip, and the more likely that it will break. Use the following illustrations as guidelines for proper Solder land design.

Recommendation of solder Land Shape and Size

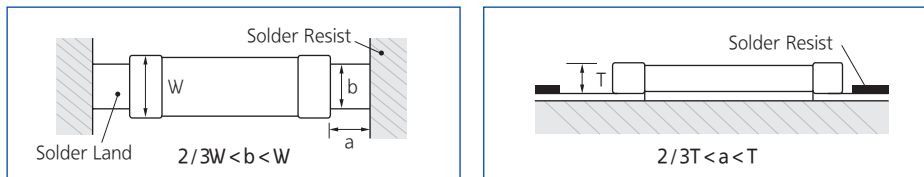

3. Adhesives

MLCCs generally require the use of an adhesive to position the chips to the circuit board prior to soldering.

3-1. Requirements for Adhesives

- They must have enough adhesion so that the chips will not fall off or move during the handling of the circuit board.
- They must maintain their adhesive strength when exposed to soldering temperatures.
- They should not spread or run when applied to the circuit board.
- They should have a long pot life.
- They should harden quickly.
- They should not corrode the circuit board or chip material.
- They should be a good insulator.
- They should be non-toxic, and not produce harmful gases, nor be harmful when touched.

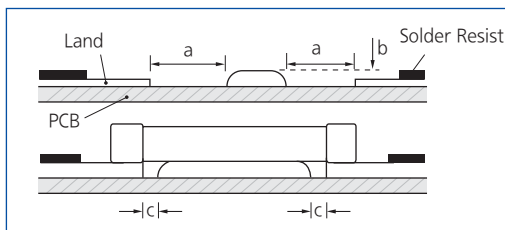

Type	21	31
a	Min. 0.2	Min. 0.2
b	70 ~ 100 μm	70 ~ 100 μm
c	> 0	> 0

3-2. Application Method

It is important to use the proper amount of adhesive. Too little will cause poor adhesion to the circuit board, and too much may strain the conductor pattern, thereby causing defective soldering. The following illustrations show the proper quantity of adhesive.

3-3. Adhesive hardening Characteristics

To prevent oxidation of the terminations, the adhesive must harden at 160°C or less, within 2 minutes or less.

4. Mounting

4-1. Mounting Head Pressure

Excessive pressure will cause chip capacitors to crack.
The pressure between nozzle and chip capacitor will be 300g maximum during mounting.

4-2. Bending Stress

Bending of printed circuit board by mounting head when double-sided circuit boards are used, chip capacitors first are mounted and soldered onto one side of the board.
When the capacitors are mounted onto the other side, it is important to support the board as shown in the illustration. If the circuit board is not supported, it may bend, causing the already -installed capacitors to crack.

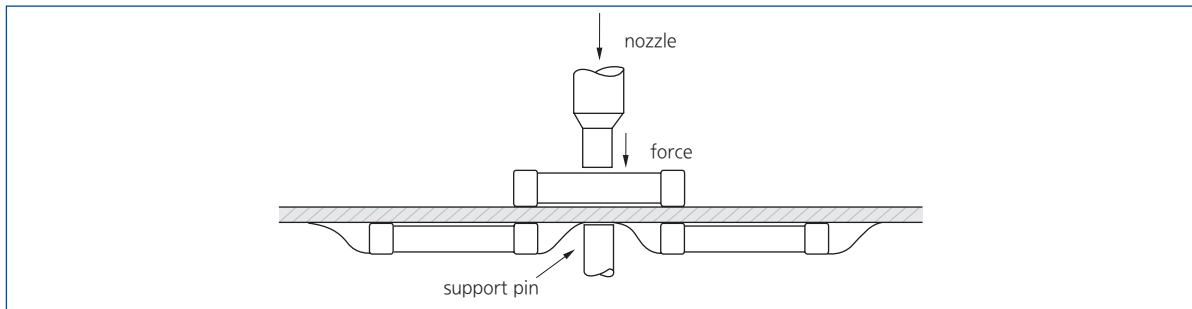

5. Flux

Although highly -activated flux gives better solderability, substances which increase activity may also degrade the insulation of the chip capacitors. To avoid such degradation, it is recommended that a mildly activated rosin flux (less than 0.2% chlo.rine) be used

6. Soldering

Since a multilayer ceramic chip capacitor comes into direct contact with melted solder during soldering, it is exposed to potentially mechanical stress caused by the sudden temperature change. The capacitor may also be subject to silver migration, and to contamination by the flux. Because of these factors, soldering technique is critical.

6-1. Soldering Methods

Method	Classification	
Reflow soldering	- Overall heating	- Infrared rays - Hot plate - VPS (Vapor phase)
	- Local heating	- Air heater - Laser - Light beam
Flow soldering	- Single wave - Double wave	

6-2. Soldering Profile

To avoid the crack problem by sudden temperature change, follow the temperature profile in the adjacent graph.

Application Manual for Surface Mounting

6-3. Pb-Free (Sn 100%) Plating

• REFLOW SOLDERING

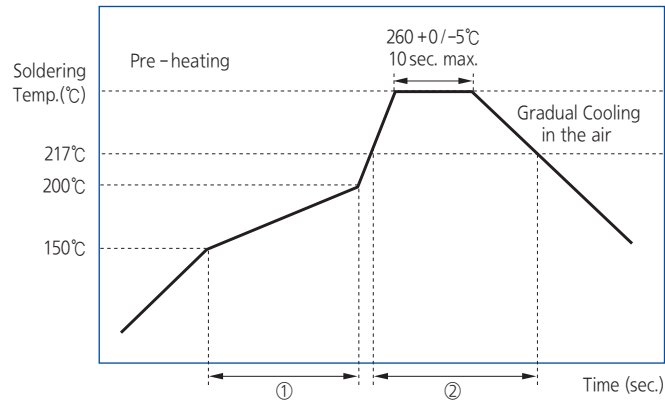

Soldering Temp.(°C)	Pre-heating Time (①, sec.)	Soldering Time(②, sec.)
260+0 / -5	60 ~ 120	60 ~ 150

• FLOW SOLDERING

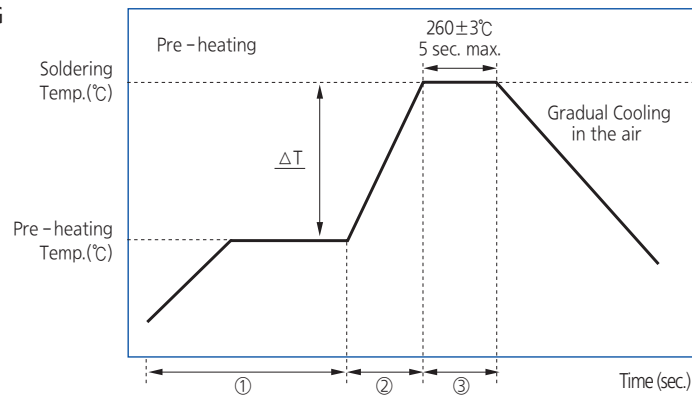

ΔT (°C)	Soldering Temp. (°C)	Pre-heating Time (① + ②, sec.)	Soldering Time (③, sec.)
≤ 150 (1206 and below size)	260 ± 3	≥ 120	≤ 5

• SOLDER IRON(Hand Soldering)

Variation of Temp.(°C)	Soldering Temp.(°C)	Pre-heating Time(sec.)	Soldering Time(sec.)	Cooling Time(sec.)	Condition of Iron Facilities		
					Wattage	Tip Diameter	Soldering Time
$\Delta T \leq 130$	$300 \pm 10^\circ\text{C}$ max.	≥ 60 sec.	≤ 4 sec.	-	20W max.	3mm max.	4 sec max.

※ Caution - Iron tip should not contact with ceramic body directly

6-4. Manual Soldering

Manual soldering can pose a great risk of creating thermal cracks in chip capacitors. The hot soldering iron tip comes into direct contact with the end terminations, and operator's carelessness may cause the tip of the soldering iron to come into direct contact with the ceramic body of the capacitor. Therefore the soldering iron must be handled carefully, and close attention must be paid to the selection of the soldering iron tip and to temperature control of the tip.

6-5. Amount of Solder

Too much Solder

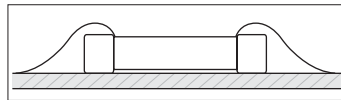

Cracks tend to occur due to large stress.

Not enough solder

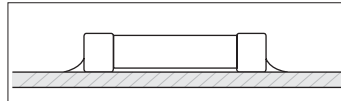

Weak holding force may cause bad connections or detaching of the capacitor

6-6. Cooling

Natural cooling using air is recommended. If the chips are dipped into solvent for cleaning, the temperature difference (ΔT) must be less than 100°C.

6-7. Cleaning

If rosin flux is used, cleaning usually is unnecessary. When strongly activated flux is used, chlorine in the flux may dissolve into some types of cleaning fluids, thereby affecting the chip capacitors. This means that the cleaning fluid must be carefully selected, and should always be new.

7. Notes for Separating Multiple, Shared PC Boards

A multi-PC board is separated into many individual circuit boards after soldering has been completed. If the board is bent or distorted at the time of separation, cracks may occur in the chip capacitors. Carefully choose a separation method that minimizes the bending of the circuit board.

Certifications

ISO / TS 16949



ISO 14001



OHSAS18001



Sony Green Partner



QC 080000 IECQ HSPM



Quality System Certification status for each factory site

Certification	Suwon (Korea)	Busan (Korea)	Calamba (Philippines)	Tianjin (China)	Binhai (China)
ISO / TS 16949	BSI TS 91430-000	BSI TS 91430-001	BSI TS 91430-005	BSI TS 91430-007	BSI TS 91430-007
Date Validity	2013-10-25 ~ 2016-10-24	2016-07-31 ~ 2018-09-14	2015-07-20 ~ 2018-07-19	2014-11-18 ~ 2017-11-17	2014-11-18 ~ 2017-11-17
ISO 14001	20BK00223-UK	20BK00223-UK	EMS_77354	CNBJ320761-UK	CNBJ320761-UK
Date Validity	2016-06-25 ~ 2018-09-14	2016-06-25 ~ 2018-09-14	2015-07-13 ~ 2018-07-12	2015-04-15 ~ 2018-04-14	2015-04-15 ~ 2018-04-14
OHSAS 18001	BK50217	BK50217	OHS_568723	CN100043A	CN100043A
Date Validity	2013-06-25 ~ 2019-06-24	2013-06-25 ~ 2019-06-24	2010-12-21 ~ 2016-10-13	2015-04-15 ~ 2018-04-14	2015-04-15 ~ 2018-04-14
QC 080000	KR-HSPM-1011	KR-HSPM-1012	PI-HSPM-1001	PRC-HSPM-1767	PRC-HSPM-1767-2
Date Validity	2016-07-02 ~ 2019-07-01	2016-07-14 ~ 2019-07-19	2016-07-11 ~ 2019-07-04	2016-07-11 ~ 2019-07-26	2016-07-11 ~ 2019-07-26
Sony Green Partner Date Validity	2016-02-22 ~ 2018-05-31	2016-02-22 ~ 2018-05-31	2016-02-22 ~ 2018-05-31	2016-02-22 ~ 2018-05-31	2016-02-22 ~ 2018-05-31

Homepage

<http://www.Samsungsem.com>

SEMCO LCR web-site

SEMCO web-site supports all technical data & information for our partner.

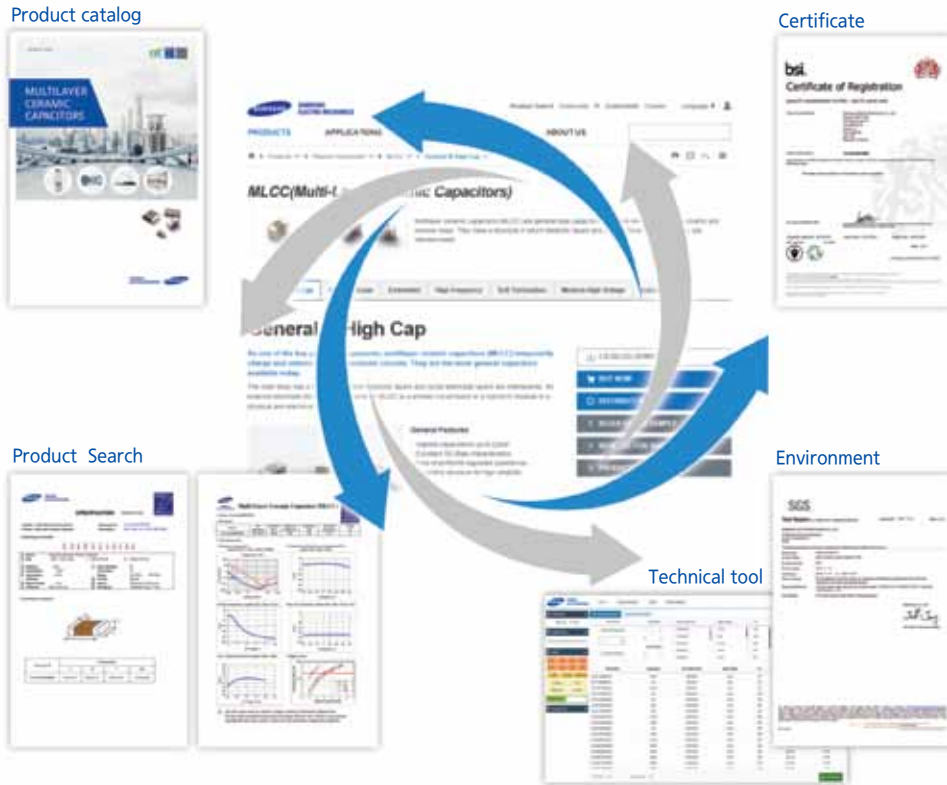

Certifications

LCR Web Library

The software of "LCR Web Library" provides the characteristics of SEMCO's products on the website. (<http://weplib.samsungsem.com/>)

- S-parameter and Spice Model of MLCC, Inductor and Bead.
- The acoustic noise data of MLCC
- Capacitance of MLCC according to Temperature and DC bias

The screenshot shows the 'LCR Web Library' interface with a search and filter table for MLCC components. The table columns include Part Number, Capacitance, Size (WxHxmm), Rated Voltage, TOC, Thickness Max, and Tolerance. The interface also includes a search bar, filter options, and a list of selected parts.

Part Number	Capacitance	Size (WxHxmm)	Rated Voltage	TOC	Thickness Max	Tolerance
CL311048P2N1N	100pF	02050816	4Vdc	375	0.21 mm	±20%
CL311058P2N1N	1uF	02050816	4Vdc	375	0.25mm	±20%
CL311424P2N1N	470pF	02050817	4Vdc	375	0.21 mm	±20%
CL524102P2N1N	10pF	01055402	10Vdc	35R	0.22 mm	±10%
CL524102P2N1N	10pF	01055402	6.3Vdc	35R	0.22 mm	±10%
CL524103P2N1N	10pF	01055402	10Vdc	35R	0.22 mm	±10%
CL524103P2N1N	10pF	01055402	6.3Vdc	35R	0.22 mm	±10%
CL524104G2N1N	100pF	01055402	4Vdc	35R	0.22 mm	±20%
CL524105W4R00	1uF	01055402	6.3Vdc	35R	0.22 mm	±20%
CL524162P2N1N	1.8pF	01055402	10Vdc	35R	0.22 mm	±10%
CL524222P2N1N	2.2pF	01055402	10Vdc	35R	0.22 mm	±10%
CL524242P2N1N	220pF	01055402	6.3Vdc	35R	0.22 mm	±20%
CL52462G2N1N	6.8pF	01055402	6.3Vdc	35R	0.22 mm	±10%
CL525214P2N1N	220pF	01055402	10Vdc	37R	0.22 mm	±10%
CL525314P2N1N	330pF	01055402	10Vdc	37R	0.22 mm	±10%

Disclaimer & Limitation of Use and Application

1. This catalogue is valid only to the products purchased either from us or through our official distributors. Should you have any question regarding our product specifications, please contact our sales personnel or application engineers.
2. Product specifications included in this catalogue are effective as of [September. 30, 2016]. Please be advised that they are standard product specifications for reference only. We may change, modify or discontinue the product specifications without notice at any time. Before placing an order, you need to check with our personnel about the validity of the product specifications that you are referring to.
3. We may modify or cease to produce the products listed in this catalogue without notice.
4. Without obtaining our permission, you should not be allowed to reproduce, copy, use or transfer any content or information contained this catalogue in any manner whatsoever for any purpose.
5. WE WILL NOT ASSUME ANY RESPONSIBILITIES WHATSOEVER FOR ANY CLAIM, DISPUTE, DAMAGE OR LIABILITY WITH REGARDS TO THE INTELLECTUAL PROPERTY RIGHTS OR OTHER RELATED RIGHTS OF OURS OR ANY THIRD PARTY ASSOCIATED WITH YOUR USE OF OUR PRODUCTS AND/OR INFORMATION CONTAINED IN THIS CATALOGUE. WE EXPRESSLY DISCLAIM THAT NO LICENSE IS GRANTED REGARDING THE AFOREMENTIONED RIGHTS.
6. THE PRODUCTS LISTED IN THIS CATALOGUE ARE NOT DESIGNED AND MANUFACTURED FOR ANY USE AND APPLICATIONS SET FORTH BELOW. PLEASE NOTE THAT ANY MISUSE OF THE PRODUCTS DEVIATING FROM PRODUCTS SPECIFICATIONS OR INFORMATION PROVIDED IN THIS CATALOGUE MAY CAUSE SERIOUS PROPERTY DAMAGES OR PERSONAL INJURY. WE WILL NOT BE LIABLE FOR ANY DAMAGES RESULTING FROM ANY MISUSE OF THE PRODUCTS, SPECIFICALLY INCLUDING USING THE PRODUCTS FOR HIGH RELIABILITY APPLICATIONS AS LISTED BELOW.

IF YOU HAVE ANY QUESTIONS REGARDING THIS 'LIMITATION OF USE AND APPLICATION', YOU SHOULD FIRST CONTACT OUR SALES PERSONNEL OR APPLICATION ENGINEERS.

- ① Aerospace/Aviation equipment
- ② Medical equipment
- ③ Military equipment
- ④ Disaster prevention/crime prevention equipment
- ⑤ Any other applications with the same as or similar complexity or reliability to the applications set forth above.



A series of horizontal dashed lines for writing, spanning the width of the page.



Passive components sales offices

Head office

Maeyoung-ro 150 (Maetan-dong) Yeongtong-gu, Suwon-city, Gyeonggi Province, Korea 16674
Tel : +82-31-210-5114

America Sales Office

San Jose Office
Samsung Electromechanics America Inc
3655 North First Street
San Jose, CA, 95134
TEL : +1-503-869-8083
E-mail : philip.elliott@samsung.com

Europe Sales Office

Frankfurt office
Samsung Electro-Mechanics GmbH, Kölnerstr. 12
65760 Eschborn Germany
TEL : + 49-6196-66-7259
E-mail : benjamin.blume@samsung.com

Domestic Distributors

Korchip Corporation
359, Manan-ro, Manan-gu, Anyang-si, Gyeonggi-do, Korea
Tel :+82-31-361-8100
E-mail : parts@korchip.com

SAMT
315, Yeongdong-daero, Gangnam-gu, Seoul, Korea
Tel : +82-2-3458-9000
E-mail : info@isamt.com

CHUNGMAC
13, Heungdeok 1-ro, Giheung-gu, Yongin-si,
Gyeonggi-do, Korea
Tel : +82-31-234-2367
E-mail : webmaster@chungmac.co.kr

YOUNGDUK
632, Seobusaet-gil, Geumcheon-gu, Seoul, Korea
Tel : +82-2-2107-7860
E-mail : dryblood@hanmail.net

Asia Sales Offices

Shenzhen Office
Shenzhen Office-14F, Tower A, SCC Building, Junction of Houhai Blvd.
and Haide 1st Rd., Nanshan Dist., Shenzhen City, China
TEL : +86-755-8608-5562
E-mail : alex77.zhang@samsung.com

Shanghai Office
9F Room CD, Shanghai HNA Building, No.898 Pu Ming Rd.,
Pudong New Area Dist., Shanghai City, China, 200122
TEL : +86-21-2231-4353
E-mail : jerry.qu@samsung.com

Beijing Office
14F Room C1C2, China Merchants Tower, No.118 Jianguo Rd.,
Chaoyang Dist., Beijing City, China, 100022
TEL : +86-10-6566-8100-6606
E-mail : kiko.wang@samsung.com

Taipei Office
9F-1, No.399 Rueykuang Rd., Neihu Dist., Taipei City, Taiwan
TEL : +886-2-2656-8350
E-mail : kevin0130.wang@samsung.com

Japan(Tokyo) Office
Samsung Electro-Mechanics Japan Co.,Ltd
-ShinagawaGrand Central Tower 9F,
2-16-4, Kounan, Minato-ku, Tokyo, Japan
TEL : +81-3-6369-6452
E-mail : hikota.suga@samsung.com

Singapore Office
Samsung Electro-Mechanics Private Limited - 3 Church Street
Samsung Hub #23-01 Singapore
TEL : +65-6933-2636
E-mail : jessica.benegildo@samsung.com

India Office
Vipul Tech Square, Tower C, Golf Course Road, Sector - 43,
Gurgaon - 122001, Haryana, India
TEL : +91-124-4841800
E-mail : munish.kumar@samsung.com

Passive components manufacturing sites

Suwon Plant(Korea)
Meayoungro 150 (Maetan-dong) Yeongtong-gu,
Suwon Gyeonggi-do 16674
Tel : +82-31-210-5114

Busan Plant (Korea)
Noksan Saneopjungro 333 (Songjeong-dong),
Gangseo-gu, Busan 46754
Tel : +82-51-970-7114, 8114

Tianjin Plant (China)
27, Heiniucheng-Road,Tianjin, China 300210
Tel : +86-22-2830-3333

Binhai Plant(China)
80, Xiaqing road, TEDA west district, Tianjin, China
TEL : +86-22-2830-3333(3500)

Philippines Plant (Philippines)
BLK 5&6 Calamba Premiere International Park Brgy.
Batino Calamba, Laguna Philippines
TEL : +63-49-508-8300