

IEC Appliance Inlet C14 with Filter

Standard- or Medical-Filter



### Description

- Panel Mount:  
Snap-in or screw-on mounting from front side
- 2 Functions:  
Appliance Inlet Protection class I, Line filter in standard and medical version
- Quick connect terminals 6.3 x 0.8 mm

### Approvals

- VDE Certificate Number: 40035745
- UL File Number: E72928
- CCC File Number: 2006010204191430

### Characteristics

- Ultra-compact design
- All single elements are already wired
- Suitable for use in equipment according to IEC/UL 60950
- Suitable for use in medical equipment according to IEC/UL 60601-1

### Other versions on request

- Capacity CX 100 nF
- Medical version M80

### References

Alternative: version without line filter [6100-3](#)

### Weblinks

[pdf-datasheet](#), [html-datasheet](#), [General Product Information](#), [RoHS](#), [CHINA-RoHS](#), [REACH](#), [Mating Connectors](#), [e-Shop](#), [SCHURTER-Stock-Check](#), [Distributor-Stock-Check](#), [Accessories](#), [Wire Harnessing](#)

### Technical Data

Ratings IEC	1 - 10A @ Ta 40 °C / 250 VAC; 50Hz
Ratings UL/CSA	1 - 15A @ Ta 40 °C / 125 VAC; 60Hz
Leakage Current	standard < 0.5 mA (250 V / 60Hz) medical < 5 µA (250 V / 60 Hz)
Dielectric Strength	> 1.7 kVDC between L-N > 2.7 kVDC between L/N-PE Test voltage (2 sec)
Allowable Operation Temp.	-25 °C to 85 °C
Climatic Category	25/085/21 acc. to IEC 60068-1
Degree of Protection	from front side IP 40 acc. to IEC 60529
Protection Class	Suitable for appliances with protection class I acc. to IEC 61140
Terminal	Quick connect terminals 6.3 x 0.8 mm
Panel Thickness s	Screw: max 5 mm Mounting screw torque max 0.5 Nm Snap-in: 0.8 mm to 3 mm
Material: Housing	Thermoplastic, black, UL 94V-0

Appliance-Inlet/-Outlet	C14 acc. to IEC 60320, UL 498, CSA C22.2 no. 42 (for cold conditions) pin-temperature 70 °C, 10A, Protection Class I
Line Filter	Standard and Medical Version, IEC 60939, UL 1283, CSA C22.2 no. 8 <a href="#">Technical Details</a>
MTBF	> 3'100'000h acc. to MIL-HB-217 F

**Dimension**

Screw-on mounting

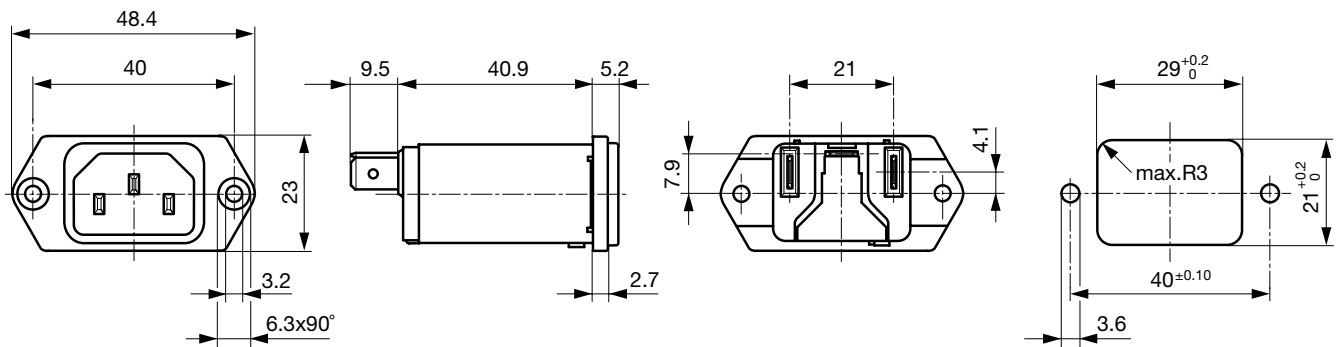

Snap-in mounting

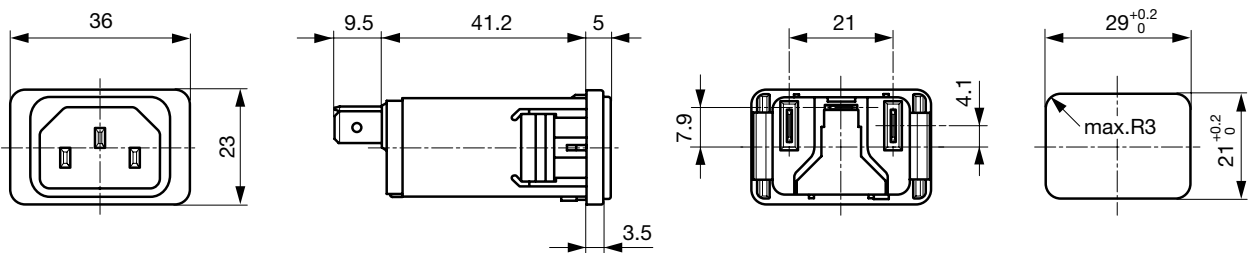
**Technical Data of Filter-Components**

Rated Current [A]	Filter-Type	Inductances L [mH]	Capacitance CX [nF]	Capacitance CY [nF]	R [MΩ]
1	Standard Version	2 x 11	47	2.2	-
2	Standard Version	2 x 4	47	2.2	-
3	Standard Version	2 x 2.5	47	2.2	-
4	Standard Version	2 x 1.6	47	2.2	-
6	Standard Version	2 x 0.7	47	2.2	-
8	Standard Version	2 x 0.6	47	2.2	-
10	Standard Version	2 x 0.4	47	2.2	-
15	Standard Version	2 x 0.1	47	2.2	-
1	Medical Version (M5)	2 x 11	47	-	1
2	Medical Version (M5)	2 x 4	47	-	1
3	Medical Version (M5)	2 x 2.5	47	-	1
4	Medical Version (M5)	2 x 1.6	47	-	1
6	Medical Version (M5)	2 x 0.7	47	-	1
8	Medical Version (M5)	2 x 0.6	47	-	1
10	Medical Version (M5)	2 x 0.4	47	-	1
15	Medical Version (M5)	2 x 0.1	47	-	1
10	Standard and Medical Version	2 x 0.4	47	2.2	1

Diagrams

Standard version

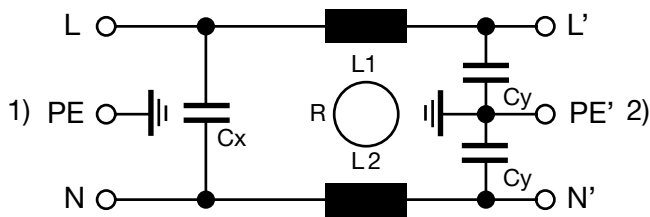

1) Line  
2) Load

Medical version

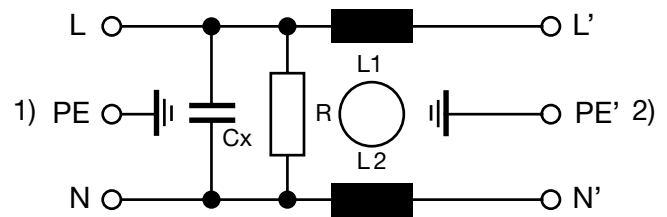

1) Line  
2) Load

Attenuation Loss

---- differential mode    \_\_\_\_ common mode

Standard version

1 A

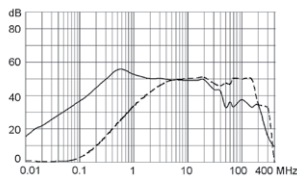

2 A

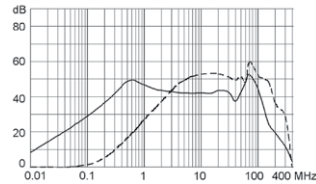

3 A

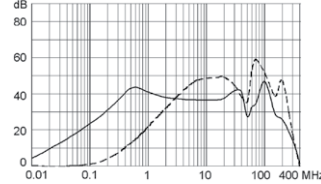

4 A

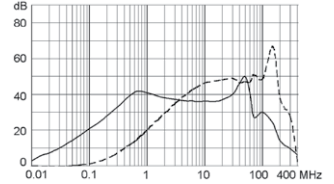

6 A

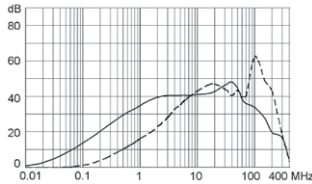

8 A

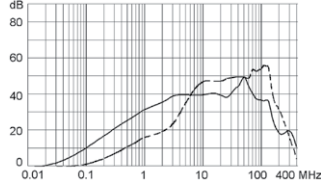

10 A

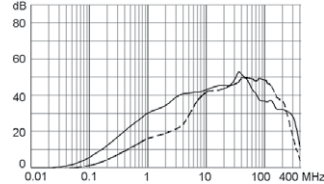

15 A

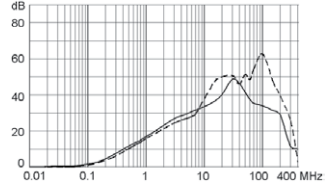

Medical version (M5)

1 A

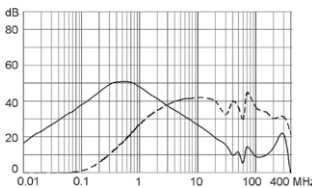

2 A

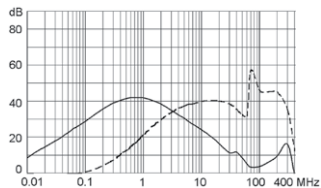

3 A

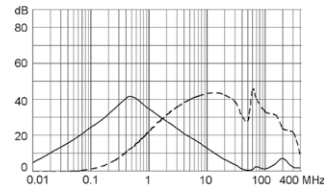

4 A

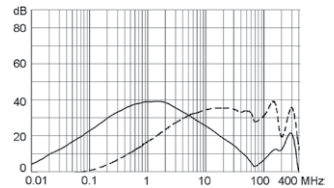

6 A

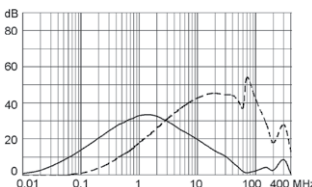

8 A

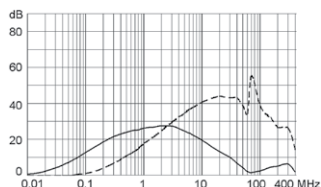

10 A

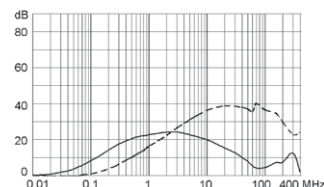

15 A

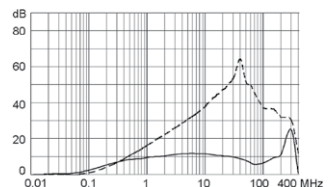

## All Variants

Rated Current [A]	Filter-Type	Panel mounting	Order Number	
1	Standard Version	Snap-in	5110.0143.1	■
2	Standard Version	Snap-in	5110.0243.1	■
3	Standard Version	Snap-in	5110.0343.1	■
4	Standard Version	Snap-in	5110.0443.1	■
6	Standard Version	Snap-in	5110.0643.1	■
8	Standard Version	Snap-in	5110.0843.1	
10	Standard Version	Snap-in	5110.1043.1	■
15	Standard Version	Snap-in	5110.1543.1	■
1	Standard Version	Screw	5110.0133.1	■
2	Standard Version	Screw	5110.0233.1	
3	Standard Version	Screw	5110.0333.1	■
4	Standard Version	Screw	5110.0433.1	
6	Standard Version	Screw	5110.0633.1	■
8	Standard Version	Screw	5110.0833.1	
10	Standard Version	Screw	5110.1033.1	■
15	Standard Version	Screw	5110.1533.1	■
1	Medical Version (M5)	Snap-in	5110.0143.3	
2	Medical Version (M5)	Snap-in	5110.0243.3	
3	Medical Version (M5)	Snap-in	5110.0343.3	
4	Medical Version (M5)	Snap-in	5110.0443.3	
6	Medical Version (M5)	Snap-in	5110.0643.3	
8	Medical Version (M5)	Snap-in	5110.0843.3	
10	Medical Version (M5)	Snap-in	5110.1043.3	■
15	Medical Version (M5)	Snap-in	5110.1543.3	■
1	Medical Version (M5)	Screw	5110.0133.3	
2	Medical Version (M5)	Screw	5110.0233.3	
3	Medical Version (M5)	Screw	5110.0333.3	
4	Medical Version (M5)	Screw	5110.0433.3	
6	Medical Version (M5)	Screw	5110.0633.3	■
8	Medical Version (M5)	Screw	5110.0833.3	
10	Medical Version (M5)	Screw	5110.1033.3	■
15	Medical Version (M5)	Screw	5110.1533.3	■

■ Most Popular.

Availability for all products can be searched real-time:<http://www.schurter.com/en/Stock-Check/Stock-Check-SCHURTER>

## Packaging unit

10 Pcs

Accessories

Description



Wire Harness  
Wire harness for SCHURTER products

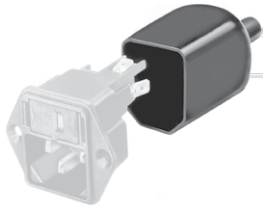

Assorted Covers  
Rear Cover



Cord retaining kits  
Cord retaining strain relief

Mating Outlets/Connectors

Category / Description

Appliance Outlet Overview complete



IEC Appliance Outlet F, Screw-on Mounting, Front Side, Solder Terminal	4787
IEC Appliance Outlet F, Snap-in Mounting, Front Side, Solder or Quick-connect Terminal	4788
IEC Appliance Outlet F or H, Screw-on Mounting, Front Side, Solder, PCB or Quick-connect Terminal	5091

Appliance Outlet further types to 5110

Connector Overview complete



IEC Connector C13, Rewireable, Straight	4782
IEC Connector C13, Rewireable, Straight	4022
IEC Connector C13, Rewireable, Angled	4785
IEC Connector C13, Rewireable, Angled	4300-06
IEC Connector C13, Rewireable, Angled	4012

Connector further types to 5110