

IEC Appliance Inlet C14 or C18 with Filter, Protection Degree IP65 into the Appliance, Fuseholder 1- or 2-pole, Front or Rear Mounting

Medical fuse drawer



V-Lock



Mounting from front side



Mounting from rear side



5707 with sealing kit IP 54 for cord connection



Description

- Panel Mount:
Screw-on version from front or rear side, Screws with sealing are included
- 4 Functions:
Appliance Inlet protection class I or II, Line filter in standard and medical version, Fuseholder for fuse-links 5 x 20 mm, IP 65 protection into the appliance
- For front side mounting versions a sealing kit IP 54 for the power supply connection is available as an accessory: 4700.0021
- Option suffix ".22" offers IP54 for the power input in combination with V-Lock cordsets
- Quick connect terminals 6.3 x 0.8 mm

Approvals

- VDE Certificate Number: 40016382
- UL File Number: E72928

Characteristics

- Extreme robust design
- All single elements are already wired
- Screw type fuse carrier, slotted
- With EMC-shield
- Especially for applications in rough environments
- Suitable for use in equipment according to IEC/UL 60950
Suitable for use in medical equipment according to IEC/UL 60601-1

Other versions on request

- With solder terminals
- Class X1- and Y1-capacitors for enhanced withstand voltage
- Medical version M80
- Additional factory-mounted sealing (IP54) of power input
- Version with current rating 3 A

Weblinks

[pdf-datasheet](#), [html-datasheet](#), [General Product Information](#), [RoHS](#), [CHINA-RoHS](#), [REACH](#), [Mating Connectors](#), [e-Shop](#), [SCHURTER-Stock-Check](#), [Distributor-Stock-Check](#), [Accessories](#), [Wire Harnessing](#)

Newly available variants corresponding to V-Lock mating cordset. The connector is equipped with a notch intended for use with the latching cordset. The cord latching system prevents against accidental removal of the cordset.

Technical Data

Ratings IEC	1 - 8A @ Ta 40 °C / 250VAC; 50Hz	Appliance-Inlet/-Outlet	C14 / C18 acc. to IEC 60320
Ratings UL/CSA	1 - 8A @ Ta 40 °C / 125VAC; 60Hz		UL 498, CSA C22.2 no. 42 (for cold conditions) pin-temperature 70 °C, 8A, Protection Class I or II
Leakage Current	standard < 0.5 mA (250 V / 60Hz) medical < 5 µA (250 V / 60 Hz)	Fuseholder	1 or 2 pole, Shocksafe category PC2 acc. to IEC 60127-6, for fuse-links 5 x 20mm
Dielectric Strength	> 1.7 kVDC between L-N > 2.7 kVDC between L/N-PE Test voltage (2 sec)	Rated Power Acceptance @ Ta 23 °C	5 x 20: 1.6W 1-pole/ 1,2W 2-pole per pole
Allowable Operation Temp.	-25°C to 85°C	Power Acceptance @ Ta > 23°C	Admissible power acceptance at higher ambient temperature see derating curves
Climatic Category	25/085/21 acc. to IEC 60068-1	Line Filter	Standard and Medical Version, IEC 60939, UL 1283, CSA C22.2 no. 8 Technical Details
Degree of Protection	from front side IP 65 acc. to IEC 60529 from rear-side IP 65 acc. to IEC 60529	MTBF	> 2'800'000h acc. to MIL-HB-217 F
Protection Class	Suitable for appliances with protection class I or II acc. to IEC 61140		
Terminal	Quick connect terminals 6.3 x 0.8 mm		
Panel Thickness s	Screw, max 3mm Mounting screw torque max 0.8Nm 2 screws M3 with sealing are provided		
Material: Housing	black / white / metallic, UL 94V-0		

Dimension

Mounting from front side

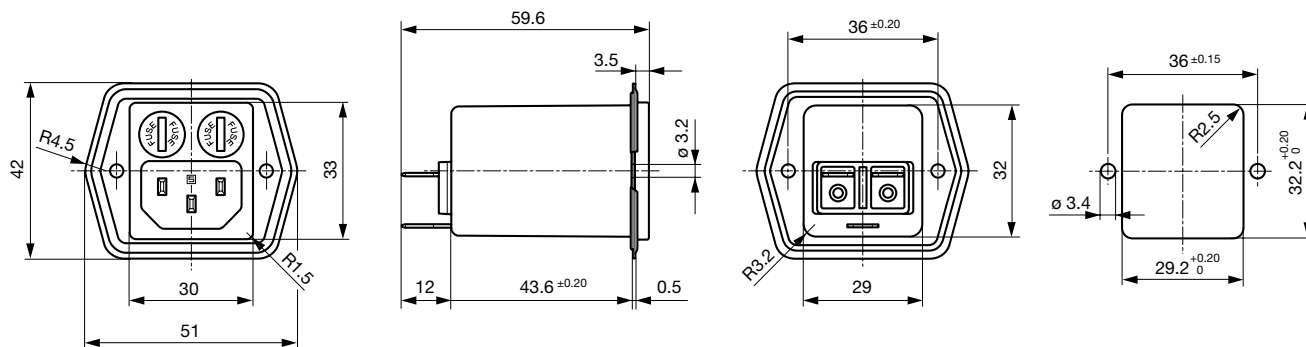

Mounting from rear side

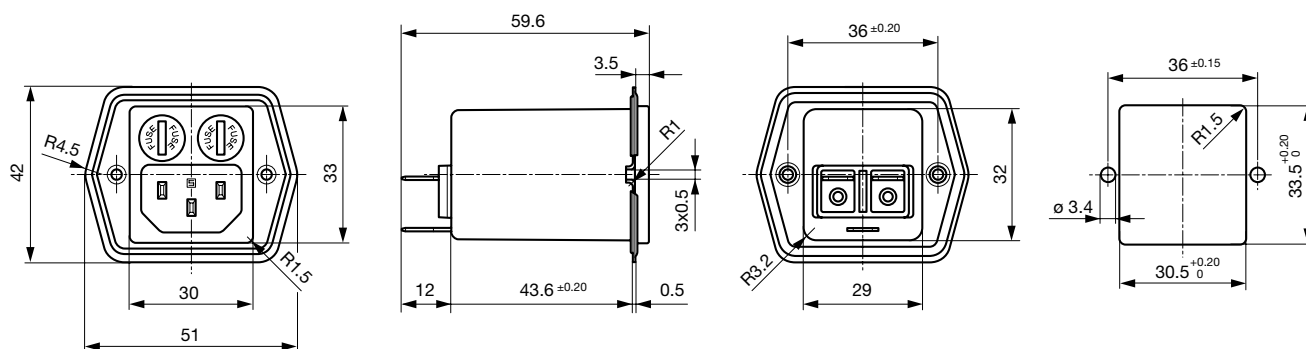
**Assembly Instructions**

Mounting sealing kit IP 54 for the power supply (only for frontside mounting)

Mating cordsets to sealing kit

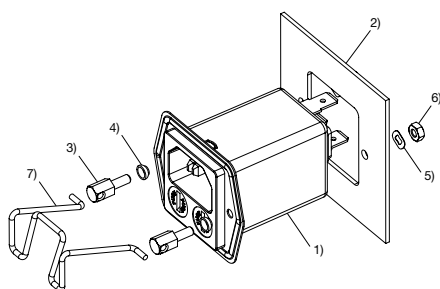

- 1) Power entry module with factory-mounted inlet gasket
- 2) Chassis
- 3) Pillar
- 4) Gasket ring
- 5) Crinkle washer
- 6) Nut
- 7) Retaining clip

Part no	Country plug	Cable length	Cross section	Color
6000.0214	open end	2.0 m	3x1 mm ²	black
6003.0215	EURO plug	2.5 m	3x1 mm ²	black
6004.0215	EURO plug	2.5 m	3x1 mm ²	black
6007.0212	EURO plug	1.0 m	3x1 mm ²	black
6007.0214	EURO plug	2.0 m	3x1 mm ²	black
6004.0114	EURO plug	2.0 m	3x0.75 mm ²	black
6026.0215	Italy	2.5 m	3x1 mm ²	black
6009.1315	North America	2.5 m	3x18 AWG	black
6047.6414	North America	2.0 m	3x0.75 mm ²	black
6009.1214	North America	2.0 m	3x18 AWG	black
6011.0215	Switzerland	2.5 m	3x1 mm ²	black
6044.0215	United Kingdom	2.5 m	3x1 mm ²	black

Mounting standard version

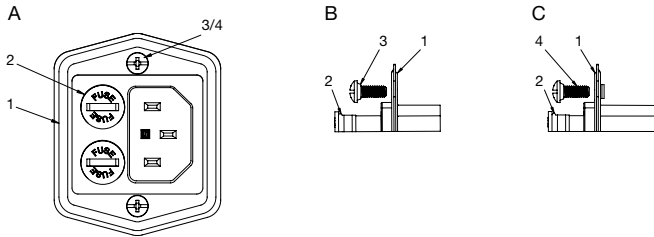

- A) front view
- B) detail front mounting type
- C) detail rear mounting type

- 1) sealing of flange
- 2) sealing of fuseholder
- 3) sealing of screw hole (front mounting type: sealing ring on screw head)
- 4) sealing of screw hole (rear mounting type: sealing on screw thread)

Important:

- use supplied fuse caps (2) and mounting screws (3/4)
- optimal sealing requires even and solid panel opening
- recommended tightening torque for mounting screws (2/3/4): 0.5-0.8 Nm
- IP65 protection between the inlet and connector pins, but no IP rating between the connector pins and the plug of the power cord!

Technical Data of Filter-Components

Rated Current [A]	Filter-Type	Inductances L [mH]	Capacitance CX [nF]	Capacitance CY [nF]	R [MΩ]
1	Standard Version	2 x 12	100	2.2	1
2	Standard Version	2 x 5.2	100	2.2	1
4	Standard Version	2 x 2	100	2.2	1
6	Standard Version	2 x 0.8	100	2.2	1
8	Standard Version	2 x 0.4	100	2.2	1
1	Medical Version (M5)	2 x 12	100	-	1
2	Medical Version (M5)	2 x 5.2	100	-	1
4	Medical Version (M5)	2 x 2	100	-	1
6	Medical Version (M5)	2 x 0.8	100	-	1
8	Medical Version (M5)	2 x 0.4	100	-	1
2	Medical Version (M80)	2 x 5.2	100	0.47	1

Diagrams

Standard version

Medical version M5

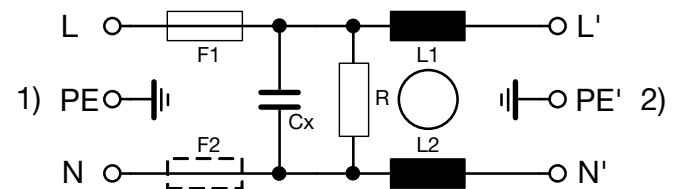
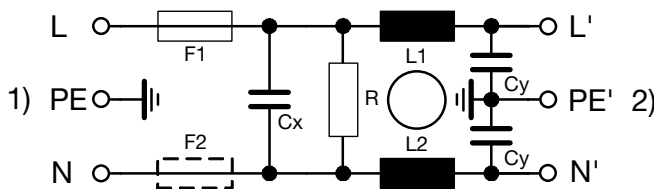

- 1) Line
- 2) Load

- 1) Line
- 2) Load

Derating Curves

1-pole

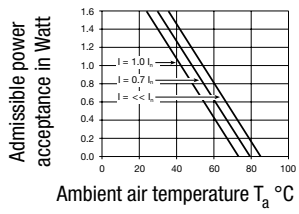

2-pole

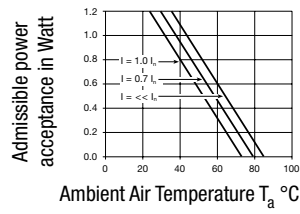

Attenuation Loss

Standard version

--- differential mode ____ common mode

1 A

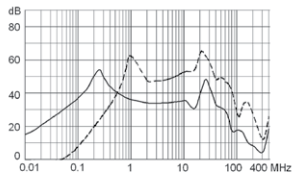

2 A

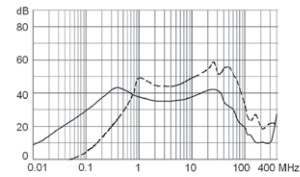

4 A

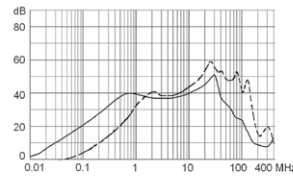

6 A

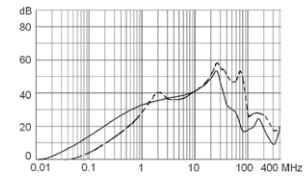

8 A

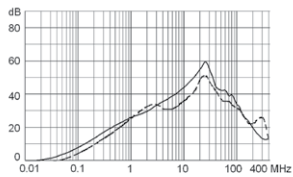

Medical version (M5)

1 A

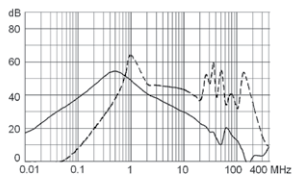

2 A

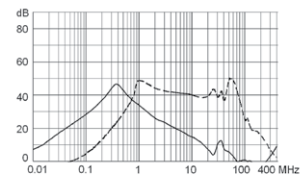

4 A

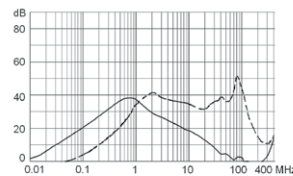

6 A

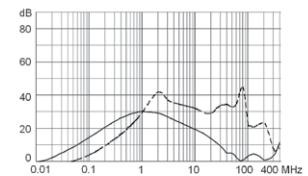

8 A

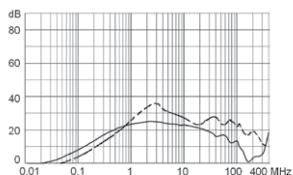

All Variants

Rated Current [A]	Filter-Type	Screw-on or rivet mounting version from front side	Screw-on version from rear with pre-formed, threaded holes for M3 screws	Protection Class	Fuseholder	Order Number
1	Standard Version	●		I	1-pole	5707.0101.112
2	Standard Version	●		I	1-pole	5707.0201.112
4	Standard Version	●		I	1-pole	5707.0401.112
6	Standard Version	●		I	1-pole	5707.0601.112
8	Standard Version	●		I	1-pole	5707.0801.112
1	Standard Version		●	I	1-pole	5707.0101.113
2	Standard Version		●	I	1-pole	5707.0201.113
4	Standard Version		●	I	1-pole	5707.0401.113
6	Standard Version		●	I	1-pole	5707.0601.113
8	Standard Version		●	I	1-pole	5707.0801.113
1	Standard Version	●		I	2-pole	5707.0101.312
2	Standard Version	●		I	2-pole	5707.0201.312
4	Standard Version	●		I	2-pole	5707.0401.312
6	Standard Version	●		I	2-pole	5707.0601.312
8	Standard Version	●		I	2-pole	5707.0801.312
8	Standard Version	●		I	2-pole	5707.0801.312.01
1	Standard Version		●	I	2-pole	5707.0101.313
2	Standard Version		●	I	2-pole	5707.0201.313
4	Standard Version		●	I	2-pole	5707.0401.313
6	Standard Version		●	I	2-pole	5707.0601.313
8	Standard Version		●	I	2-pole	5707.0801.313
8	Standard Version		●	I	2-pole	5707.0801.313.21
1	Medical Version (M5)	●		I	2-pole	5707.0103.312
2	Medical Version (M5)	●		I	2-pole	5707.0203.312
4	Medical Version (M5)	●		I	2-pole	5707.0403.312
6	Medical Version (M5)	●		I	2-pole	5707.0603.312
8	Medical Version (M5)	●		I	2-pole	5707.0803.312
1	Medical Version (M5)		●	I	2-pole	5707.0103.313
1	Medical Version (M5)		●	I	2-pole	5707.0103.313.21
2	Medical Version (M5)		●	I	2-pole	5707.0203.313
2	Medical Version (M5)		●	I	2-pole	5707.0203.313.21
4	Medical Version (M5)		●	I	2-pole	5707.0403.313
4	Medical Version (M5)		●	I	2-pole	5707.0403.313.21
6	Medical Version (M5)		●	I	2-pole	5707.0603.313
6	Medical Version (M5)		●	I	2-pole	5707.0603.313.21
8	Medical Version (M5)		●	I	2-pole	5707.0803.313
8	Medical Version (M5)		●	I	2-pole	5707.0803.313.21
1	Medical Version (M5)	●		II	2-pole	5707.0103.412
2	Medical Version (M5)	●		II	2-pole	5707.0203.412
4	Medical Version (M5)	●		II	2-pole	5707.0403.412
6	Medical Version (M5)	●		II	2-pole	5707.0603.412
8	Medical Version (M5)	●		II	2-pole	5707.0803.412
1	Medical Version (M5)		●	II	2-pole	5707.0103.413
2	Medical Version (M5)		●	II	2-pole	5707.0203.413
4	Medical Version (M5)		●	II	2-pole	5707.0403.413
6	Medical Version (M5)		●	II	2-pole	5707.0603.413
8	Medical Version (M5)		●	II	2-pole	5707.0803.413
2	Medical Version (M80)	●		I	2-pole	5707.0205.312.01

Most Popular.

Availability for all products can be searched real-time: <http://www.schurter.com/en/Stock-Check/Stock-Check-SCHURTER>

In addition to the IP 65 sealing to the appliance (standard version), the power input can be protected from ingressing fluids and dust with IP 54. This option is only available for front side mounting versions and can be ordered with ending ".01" (5707.xxxx.xxx.01). For the front mounting a cord retaining set is available for fixing the cord connector: 4700.0021 (sample 4700.0021.H)

Suffix ".21" corresponds to the version with V-Lock mating cordset. The connector is equipped with a notch intended for use with the latching cordset. The cord latching system prevents against accidental removal of the cordset.

Rated Current [A]	Filter-Type	Screw-on or rivet mounting version from front side	Screw-on version from rear with pre-formed, threaded holes for M3 screws	Protection Class	Fuseholder	Order Number
-------------------	-------------	----------------------------------------------------	--------------------------------------------------------------------------	------------------	------------	--------------

Suffix ".22" contains suffix ".01" and ".21", this means IP54 protection for the power input with V-Lock cordsets.

Packaging unit 10 Pcs

Accessories

Description

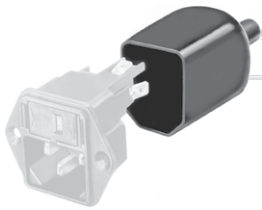

Assorted Covers
Rear Cover



Wire Harness
Wire harness for SCHURTER products

Mating Outlets/Connectors

Category / Description

[Connector Overview complete](#)



IEC Connector C15A, Rewireable, Straight	0102
IEC Connector C15A, Rewireable, Straight	0102-G
IEC Connector C15A, Rewireable, Angled	0112
IEC Connector C13, Rewireable, Angled	4012
IEC Connector C13, Rewireable, Straight	4022

[Connector further types to 5707](#)

...

[Interconnection Cord Overview complete](#)



Interconnection Cord C13, 10 A	6007.0212
Interconnection Cord C13, 10 A	6007.0214

[Interconnection Cord further types to 5707](#)

[Power Cord Overview complete](#)



Power Supply Cord with IEC plug C14, stripped end	6007.0204
---------------------------------------------------	-----------

[Power Cord further types to 5707](#)

Category / Description

[Power Supply Cord Overview complete](#)



Power Supply Cord with IEC Connector C13 straight, stripped end	6000.0214
Power Supply Cord with IEC Connector C13 angled, stripped end	6000.0224
EU Power Supply Cord with IEC Connector C13, straight	6003.0215
EU Power Supply Cord with IEC Connector C13, straight	6004.0215
US Power Supply Cord with IEC Connector C13, straight	6009.1315
Power Supply Cord further types to 5707	...

[Power Supply or Interconnection Cord Overview complete](#)

Diverse Power Supply and Interconnection Cords 10 A	6003.0204
Diverse Power Supply and Interconnection Cords 10 A	6003.0205
Diverse Power Supply and Interconnection Cords 10 A	6026.0205
UK Power Supply Cord with stripped ends	6044.0204
Diverse Power Supply and Interconnection Cords 10 A	6045.0114
Power Supply or Interconnection Cord further types to 5707	...

Mating Outlets/Connectors shuttered



[Power Cord Overview complete](#)

Overview Power Supply Cord with IEC Connector C13, V-Lock, straight	VAC13KS
Power Cord further types to 5707	