

IEC Appliance Inlet C14 or C18 with Filter, Protection Degree IP65 into the Appliance, Fuseholder 1- or 2-pole, Front or Rear Mounting

Medical fuse drawer



V-Lock



5707.xxxx.x2 Mounting from front side



5707.xxxx.xxx.22 with IP 54 V-Lock cord connection



5707 with IP 54 Inlet Gasket



### Description

- Panel Mount :  
Screw-on version from front or rear side , Screws with sealing are included
- 4 Functions :  
Appliance Inlet protection class I or II , Line filter in standard and medical version , Fuseholder for fuse-links 5 x 20 mm , IP 65 protection into the appliance
- For front side mounting versions a sealing kit IP 54 for the power supply connection is available as an accessory: 4700.0021
- Option suffix ".22" offers IP 54 for the power input in combination with V-Lock cordsets
- Quick connect terminals 6.3 x 0.8 mm

### Unique Selling Proposition

- Sealed power entry module
- Strong in Design and Safety
- IP 65 protection to the appliance
- IP 54 protection to the cord connection

### Approvals

- Approval Reference Type: 5707
- VDE Certificate Number: 40016382
- UL File Number: E72928

### Characteristics

- Extreme robust design
- All single elements are already wired
- Screw type fuse carrier, slotted
- With EMC-shield
- Especially for applications in rough environments
- Suitable for use in equipment according to IEC/UL 60950  
Suitable for use in medical equipment according to IEC/UL 60601-1

### Other versions on request

- With solder terminals
- Class X1- and Y1-capacitors for enhanced withstand voltage
- Medical version M80
- Additional factory-mounted sealing (IP54) of power input
- Version with current rating 3 A

### Weblinks

[pdf datasheet](#), [html-datasheet](#), [General Product Information](#), [RoHS](#), [CHINA-RoHS](#), [REACH](#), [Distributor-Stock-Check](#), [Accessories](#), [Detailed request for product](#)

Newly available variants corresponding to V-Lock mating cordset. The connector is equipped with a notch intended for use with the latching cordset. The cord latching system prevents against accidental removal of the cordset.

### Technical Data

Ratings IEC	1 - 8A @ Ta 40 °C / 250VAC; 50Hz	appliance inlet/-outlet	C14 / C18 acc. to IEC 60320-1
Ratings UL/CSA	1 - 8A @ Ta 40 °C / 125VAC; 60Hz		UL 498, CSA C22.2 no. 42 (for cold conditions) pin-temperature 70 °C, 8A, Protection Class I or II
Leakage Current	standard < 0.5 mA (250 V / 60 Hz) medical < 5 µA (250 V / 60 Hz)		
Dielectric Strength	> 1.7 kVDC between L-N > 2.7 kVDC between L/N-PE Test voltage (2 sec)	Fuseholder	1 or 2 pole, Shocksafe category PC2 acc. to IEC 60127-6, for fuse-links 5 x 20mm
Allowable Operation Temperature	-25 °C to 85 °C	Rated Power Acceptance @ Ta 23 °C	5 x 20: 1.6W 1-pole/ 1,2W 2-pole per pole
Climatic Category	25/085/21 acc. to IEC 60068-1	Power Acceptance @ Ta > 23 °C	Admissible power acceptance at higher ambient temperature see derating curves
IP-Protection	from front side IP 65 acc. to IEC 60529 from rear-side IP 65 acc. to IEC 60529	Line Filter	Standard and Medical Version, IEC 60939, UL 1283, CSA C22.2 no. 8 <a href="#">Technical Details</a>
Protection Class	Suitable for appliances with protection class I or II acc. to IEC 61140	MTBF	> 2'800'000h acc. to MIL-HB-217 F
Terminal	Quick connect terminals 6.3 x 0.8 mm		
Panel Thickness s	Screw, max 3mm Mounting screw torque max 0.8Nm 2 screws M3 with sealing are provided		
Material: Housing	black / white / metallic, UL 94V-0		

Detailed information on product approvals, code requirements, usage instructions and detailed test conditions can be looked up in [General Product Information](#)

## Dimension

Mounting from front side

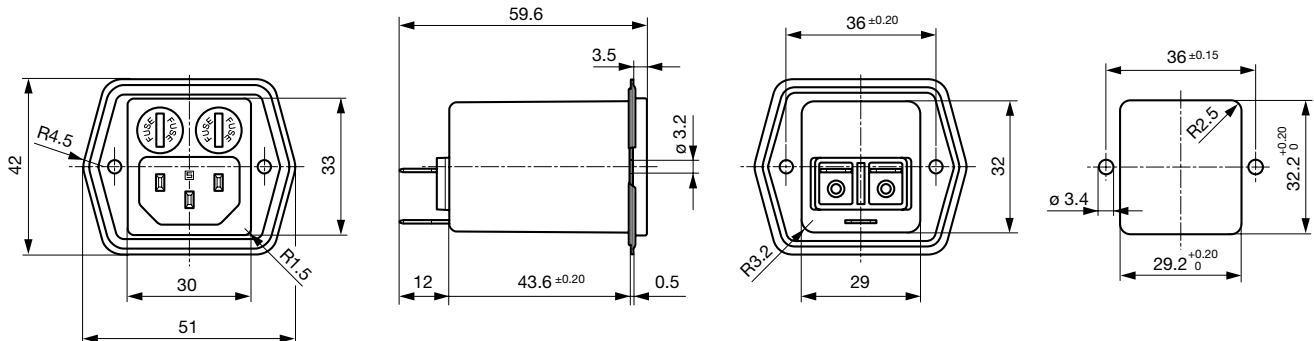

Mounting from rear side

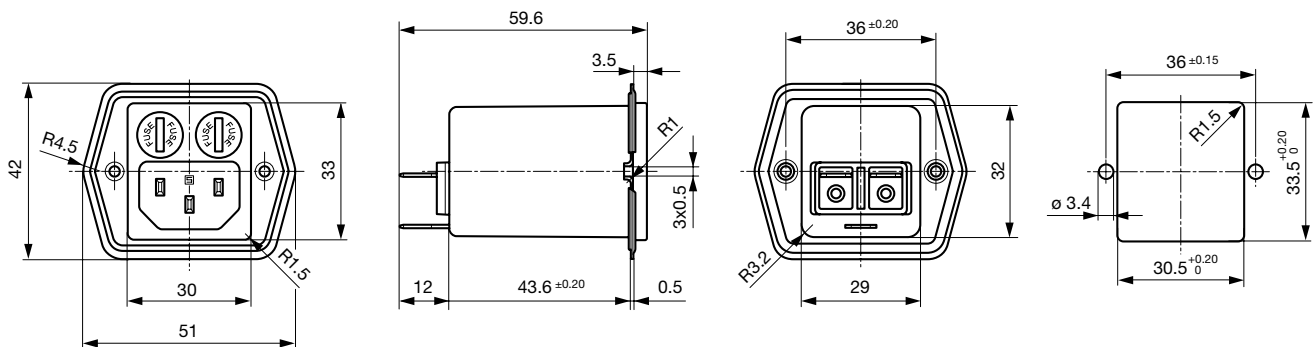

## Assembly Instructions

Mounting sealing kit IP 54 for the power supply (only for frontside mounting)

Mating cordsets to sealing kit

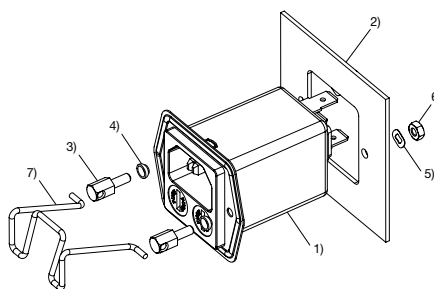

- 1) Power entry module with factory-mounted inlet gasket
- 2) Chassis
- 3) Pillar
- 4) Gasket ring
- 5) Crinkle washer
- 6) Nut
- 7) Retaining clip

Part no	Country plug	Cable length	Cross section	Color
6000.0214	open end	2.0 m	3x1 mm <sup>2</sup>	black
6003.0215	EURO plug	2.5 m	3x1 mm <sup>2</sup>	black
6004.0215	EURO plug	2.5 m	3x1 mm <sup>2</sup>	black
6007.0212	EURO plug	1.0 m	3x1 mm <sup>2</sup>	black
6007.0214	IEC plug	2.0 m	3x1 mm <sup>2</sup>	black
6004.0114	EURO plug	2.0 m	3x0.75 mm <sup>2</sup>	black
6026.0215	Italy	2.5 m	3x1 mm <sup>2</sup>	black
6009.1315	North America	2.5 m	3x18 AWG	black
6047.6414	Japan	2.0 m	3x0.75 mm <sup>2</sup>	black
6009.1214	North America	2.0 m	3x18 AWG	black
6011.0215	Switzerland	2.5 m	3x1 mm <sup>2</sup>	black
6044.0215	United Kingdom	2.5 m	3x1 mm <sup>2</sup>	black

Mounting standard version

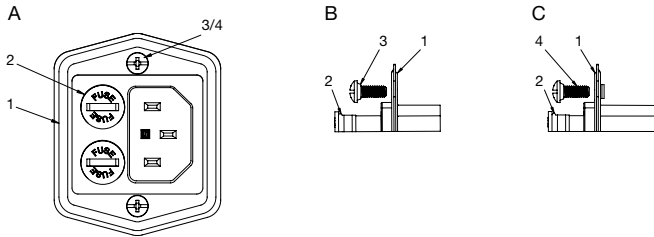

- A) front view
- B) detail front mounting type
- C) detail rear mounting type

- 1) sealing of flange
- 2) sealing of fuseholder
- 3) sealing of screw hole (front mounting type: sealing ring on screw head)
- 4) sealing of screw hole (rear mounting type: sealing on screw thread)

Important:

- use supplied fuse caps (2) and mounting screws (3/4)
- optimal sealing requires even and solid panel opening
- recommended tightening torque for mounting screws (2/3/4): 0.5-0.8 Nm
- IP65 protection between the inlet and connector pins, but no IP rating between the connector pins and the plug of the power cord!

Technical Data of Filter-Components

Rated Current [A]	Filter-Type	Inductances L [mH]	Capacitance CX [nF]	Capacitance CY [nF]	R [MΩ]
1	Standard Version	2 x 12	100	2.2	1
2	Standard Version	2 x 5.2	100	2.2	1
4	Standard Version	2 x 2	100	2.2	1
6	Standard Version	2 x 0.8	100	2.2	1
8	Standard Version	2 x 0.4	100	2.2	1
1	Medical Version (M5)	2 x 12	100	-	1
2	Medical Version (M5)	2 x 5.2	100	-	1
4	Medical Version (M5)	2 x 2	100	-	1
6	Medical Version (M5)	2 x 0.8	100	-	1
8	Medical Version (M5)	2 x 0.4	100	-	1
2	Medical Version (M80)	2 x 5.2	100	0.47	1

Diagrams

Standard version

Medical version M5

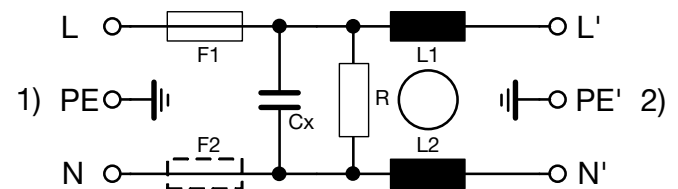
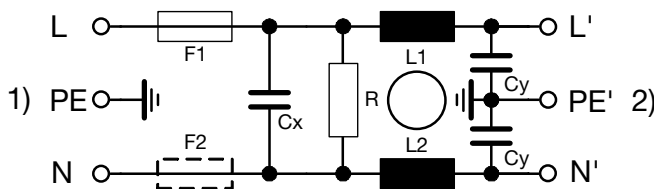

- 1) Line
- 2) Load

- 1) Line
- 2) Load

**Derating Curves**

1-pole

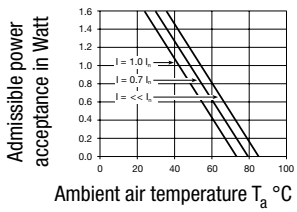

2-pole

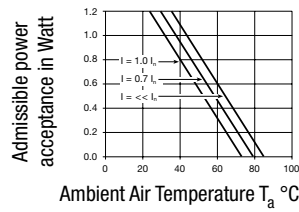

**Attenuation Loss**

Standard version

--- 50Ω differential mode    \_\_\_\_ 50Ω common mode

1 A

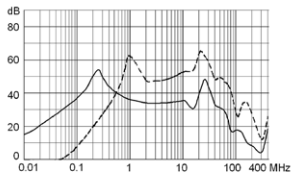

2 A

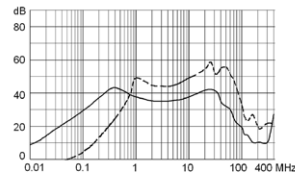

4 A

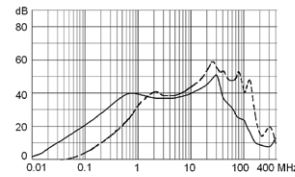

6 A

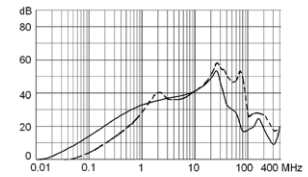

8 A

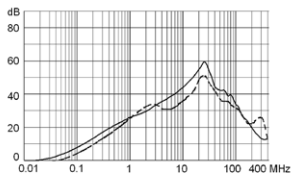

Medical version (M5)

1 A

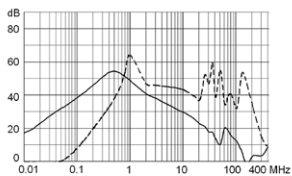

2 A

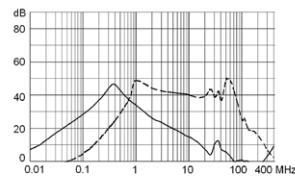

4 A

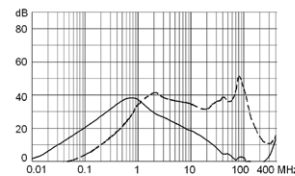

6 A

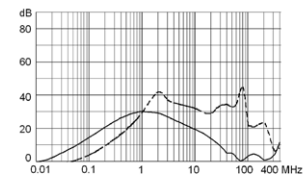

8 A

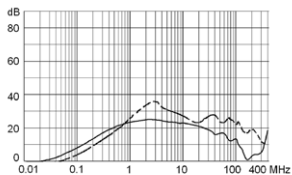

**All Variants**

Rated Current [A]	Filter-Type	Mounting side	Cord retaining kits	Protection Class	Power Cord IP-protection	Fuseholder	Color	V-Lock	Order Number
1	Standard Version	Front Side	-	I	-	1-pole	black		5707.0101.112
1	Standard Version	Rear Side	-	I	-	1-pole	black		5707.0101.113
2	Standard Version	Front Side	-	I	-	1-pole	black		5707.0201.112

Rated Current [A]	Filter-Type	Mounting side	Cord retaining kits	Protection Class	Power Cord IP-protection	Fuseholder	Color	V-Lock	Order Number
2	Standard Version	Rear Side	-	I	-	1-pole	black		5707.0201.113
4	Standard Version	Front Side	-	I	-	1-pole	black		5707.0401.112
4	Standard Version	Rear Side	-	I	-	1-pole	black		5707.0401.113
6	Standard Version	Front Side	-	I	-	1-pole	black		5707.0601.112
6	Standard Version	Rear Side	-	I	-	1-pole	black		5707.0601.113
8	Standard Version	Front Side	-	I	-	1-pole	black		5707.0801.112
8	Standard Version	Rear Side	-	I	-	1-pole	black		5707.0801.113
1	Standard Version	Front Side	-	I	-	2-pole	black		5707.0101.312
1	Standard Version	Rear Side	-	I	-	2-pole	black		5707.0101.313
2	Standard Version	Front Side	-	I	-	2-pole	black		5707.0201.312
2	Standard Version	Rear Side	-	I	-	2-pole	black		5707.0201.313
4	Standard Version	Front Side	-	I	-	2-pole	black		5707.0401.312
4	Standard Version	Rear Side	-	I	-	2-pole	black		5707.0401.313
4	Standard Version	Rear Side	-	I	IP 54	2-pole	black	●	5707.0401.313.22
6	Standard Version	Front Side	-	I	-	2-pole	black		5707.0601.312
6	Standard Version	Rear Side	-	I	-	2-pole	black		5707.0601.313
8	Standard Version	Front Side	-	I	-	2-pole	black		5707.0801.312
8	Standard Version	Front Side	-	I	IP 54	2-pole	black		5707.0801.312.01
8	Standard Version	Rear Side	-	I	-	2-pole	black		5707.0801.313
8	Standard Version	Rear Side	-	I	-	2-pole	black	●	5707.0801.313.21
1	Medical Version (M5)	Front Side	-	I	-	2-pole	black		5707.0103.312
1	Medical Version (M5)	Rear Side	-	I	-	2-pole	black		5707.0103.313
1	Medical Version (M5)	Rear Side	-	I	-	2-pole	black	●	5707.0103.313.21
2	Medical Version (M5)	Front Side	-	I	-	2-pole	black		5707.0203.312
2	Medical Version (M5)	Rear Side	-	I	-	2-pole	black		5707.0203.313
2	Medical Version (M5)	Rear Side	-	I	-	2-pole	black	●	5707.0203.313.21
4	Medical Version (M5)	Rear Side	-	I	IP 54	2-pole	black	●	3-100-897
4	Medical Version (M5)	Front Side	-	I	-	2-pole	black		5707.0403.312
4	Medical Version (M5)	Rear Side	-	I	-	2-pole	black		5707.0403.313
4	Medical Version (M5)	Rear Side	-	I	-	2-pole	black	●	5707.0403.313.21
6	Medical Version (M5)	Front Side	-	I	-	2-pole	black		5707.0603.312
6	Medical Version (M5)	Rear Side	-	I	-	2-pole	black		5707.0603.313
6	Medical Version (M5)	Rear Side	-	I	-	2-pole	black	●	5707.0603.313.21
6	Medical Version (M5)	Front Side	-	I	-	2-pole	white		5707.0613.312
6	Medical Version (M5)	Front Side	-	I	-	2-pole	white	●	5707.0613.312.21
6	Medical Version (M5)	Rear Side	-	I	-	2-pole	white		5707.0613.313
6	Medical Version (M5)	Rear Side	-	I	-	2-pole	white	●	5707.0613.313.21
8	Medical Version (M5)	Front Side	-	I	-	2-pole	black		5707.0803.312
8	Medical Version (M5)	Front Side	-	I	IP 54	2-pole	black	●	5707.0803.312.22
8	Medical Version (M5)	Rear Side	-	I	-	2-pole	black		5707.0803.313
8	Medical Version (M5)	Rear Side	-	I	-	2-pole	black	●	5707.0803.313.21
1	Medical Version (M5)	Front Side	-	II	-	2-pole	black		5707.0103.412
1	Medical Version (M5)	Rear Side	-	II	-	2-pole	black		5707.0103.413
2	Medical Version (M5)	Front Side	-	II	-	2-pole	black		5707.0203.412
2	Medical Version (M5)	Rear Side	-	II	-	2-pole	black		5707.0203.413
4	Medical Version (M5)	Front Side	-	II	-	2-pole	black		5707.0403.412
4	Medical Version (M5)	Rear Side	-	II	-	2-pole	black		5707.0403.413

Rated Current [A]	Filter-Type	Mounting side	Cord retaining kits	Protection Class	Power Cord IP-protection	Fuseholder	Color	V-Lock	Order Number
6	Medical Version (M5)	Front Side	-	II	-	2-pole	black		5707.0603.412
6	Medical Version (M5)	Rear Side	-	II	-	2-pole	black		5707.0603.413
8	Medical Version (M5)	Front Side	-	II	-	2-pole	black		5707.0803.412
8	Medical Version (M5)	Rear Side	-	II	-	2-pole	black		5707.0803.413
2	Medical Version (M80)	Front Side	-	I	IP 54	2-pole	black		5707.0205.312.01

Most Popular.

Availability for all products can be searched real-time:<http://www.schurter.com/en/Stock-Check/Stock-Check-SCHURTER>

**Packaging unit** 10 Pcs

**Accessories**

**Description**



**Wire Harness**  
Wire harness for SCHURTER products



**Assorted Covers**  
Rear Cover

0859.0047

**Mating Outlets/Connectors**

**Category / Description**

[Connector Overview complete](#)



4782 Mounting: Power Cord, 3 x 1 mm <sup>2</sup> / 3 x 18 AWG, Cable, Connector: IEC C13	4782
4022 Mounting: Power Supply Cord, 3 x 1.5 mm <sup>2</sup> , Screw clamps, Connector: IEC C13	4022
4785 Mounting: Power Cord, 3 x 1 mm <sup>2</sup> / 3 x 18 AWG, Cable, Connector: IEC C13	4785
4300-06 Mounting: Power Cord, 3 x 1 mm <sup>2</sup> / 3 x 18 AWG, Cable, Connector: IEC C13	4300-06
4012 Mounting: Power Supply Cord, 3 x 1.5 mm <sup>2</sup> , Screw clamps, Connector: IEC C13	4012
<a href="#">Connector further types to 5707</a>	...

[Interconnection Cord Overview complete](#)



Cord Sets 10 A, Interconnection, 2.0 m, IEC H05VV-F3G1.0, black	6007.0204
Cord Sets 10 A, Interconnection, 1.0 m, Connector IEC C13, H05VV-F3G1.0, black	6007.0212
Cord Sets 10 A, Interconnection, 2.0 m, Connector IEC C13, H05VV-F3G1.0, black	6007.0214
<a href="#">Interconnection Cord further types to 5707</a>	

Category / Description

[Power Supply Cord Overview complete](#)



Cord Sets 10 A, Europlug, 2.5 m, Connector IEC C13, H05VV-F3G1.0, black	6004.0215
Cord Sets 10 A, Europlug, 2.5 m, Connector IEC C13, H05VV-F3G1.0, black	6003.0215
Cord Sets 10 A, uninsulated wires, 2.0 m, Connector IEC C13, H05VV-F3G1.0, black	6000.0224
Cord Sets 10 A, uninsulated wires, 2.0 m, Connector IEC C13, H05VV-F3G1.0, black	6000.0214
Cord Sets 10 A, United Kingdom, 2.5 m, Connector IEC C13, H05VV-F3G1.0, black	6044.0215
<a href="#">Power Supply Cord further types to 5707</a>	...

[Power Supply or Interconnection Cord Overview complete](#)



Cord Sets 10 A, United Kingdom, 2.0 m, Connector IEC H05VV-F3G1.0, black	6044.0204
<a href="#">Power Supply or Interconnection Cord further types to 5707</a>	...

Mating Outlets/Connectors shuttered

[Power Cord Overview complete](#)



VAC17KS, North America, V-Lock cord retaining, 3.0 m, Connector C17, SJT 2x18 AWG, black	3-101-794
VAC17KS, North America, V-Lock cord retaining, 2.0 m, Connector C17, SJT 2x18 AWG, black	6051.2801
VAC17KS, North America, V-Lock cord retaining, 2.0 m, Connector C17, SJT 2x18 AWG, white	6051.2811
VAC17KS, United Kingdom, V-Lock cord retaining, 2.0 m, Connector IEC C17, H05VV-F2G1, black	3-101-184
VAC17KS, Switzerland, V-Lock cord retaining, 2.0 m, Connector IEC C17, H05VV-F2G1, black	3-101-185
<a href="#">Power Cord further types to 5707</a>	...