

IEC Appliance Inlet C14 or C18, sandwich Mounting, PCB- or Solder Terminal



Snap-in mounting



Screw-on mounting



Approvals and Compliances

Description

- Panel Mount :
- Snap-in or screw-on mounting on PCB , sandwich or rear-side
- Appliance Inlet , Pin temperature 70 °C , protection class I or II
- For PCB mounting

Other versions on request

- With solder terminals
- Types for enhanced glow wire test requirements acc. IEC 60695-2-12 and -13 for the use in unattended household equipment acc. IEC 60335-1
- Variant with notch for V-Lock mating Cordsets

Weblinks

[pdf datasheet](#), [html-datasheet](#), [General Product Information](#), [Distributor-Stock-Check](#), [Accessories](#), [Detailed request for product](#), [Microsite](#)

Newly available variants corresponding to V-Lock mating cordset. The connector is equipped with a notch intended for use with the latching cordset. The cord latching system prevents against accidental removal of the cordset.

Technical Data

Ratings IEC	10A / 250VAC; 50Hz	appliance inlet/-outlet	C14 / C18 acc. to IEC 60320-1, UL 498, CSA C22.2 no. 42 (for cold conditions) pin-temperature 70 °C, 10A, Protection Class I or II
Ratings UL/CSA	15A / 250VAC; 60Hz		
Dielectric Strength	> 3 kVAC between L-N > 3 kVAC between L/N-PE (1 min/50Hz)		
Allowable Operation Temperature	-25 °C to 70 °C		
IP-Protection	from front side IP 40 acc. to IEC 60529		
Insulation cover	Suitable for appliances with protection class I or II acc. to IEC 61140		
Terminal	For PCB mounting ; Ground terminal: angled to pin axis Solder terminal on request		
Panel Thickness S	Sandwich/rear-side: 1.5/2/2.5/3 mm		
Material: Housing	Thermoplastic, black, UL 94V-0		

Approvals and Compliances

Detailed information on product approvals, code requirements, usage instructions and detailed test conditions can be looked up in [Details about Approvals](#)

Approvals



The approval mark is used by the testing authorities to certify compliance with the safety requirements placed on electronic products.

Approval Reference Type: GSP2

Approval Logo	Certificates	Certification Body	Description
	<a href="#">VDE Approvals</a>	VDE	Certificate Number: 40012767
	<a href="#">UL Approvals</a>	UL	UL File Number: E96454
	<a href="#">CSA Approvals</a>	CSA	CSA Certification Record: 38456
	<a href="#">CQC Approvals</a>	CQC	CCC File Number: 2006010204183838



**Product standards**

Product standards that are referenced

Organization	Design	Standard	Description
	Designed according to	IEC 60320-1	Appliance couplers for household and similar general purposes
	Designed according to	UL 498	Standard for Attachment Plugs and Receptacles
	Designed according to	CSA C22.2 no. 42	General Use Receptacles, Attachment Plugs, and Similar Wiring Devices





**Application standards**

Application standards where the product can be used

Organization	Design	Standard	Description
	Designed for applications acc.	IEC/UL 60950	IEC 60950-1 includes the basic requirements for the safety of information technology equipment.
	Designed for applications acc.	IEC 60335-1	Safety of electrical appliances for household and similar purposes. Meets the requirements for appliances in unattended use. This includes the enhanced requirements of glow wire tests acc. to IEC 60695-2-12 and -13.

**Compliances**

The product complies with following Guide Lines

Identification	Details	Initiator	Description
	<a href="#">CE declaration of conformity</a>	SCHURTER AG	The CE marking declares that the product complies with the applicable requirements laid down in the harmonisation of Community legislation on its affixing in accordance with EU Regulation 765/2008.
	RoHS	SCHURTER AG	EU Directive RoHS 2011/65/EU
	China RoHS	SCHURTER AG	The law SJ / T 11363-2006 (China RoHS) has been in force since 1 March 2007. It is similar to the EU directive RoHS.
	REACH	SCHURTER AG	On 1 June 2007, Regulation (EC) No 1907/2006 on the Registration, Evaluation, Authorization and Restriction of Chemicals 1 (abbreviated as "REACH") entered into force.
	MicrositeV-Lock	SCHURTER AG	V-Lock system are based on a matching plug-dose combination. The connector is equipped with a notch intended for use with the latching cordset. The cord latching system prevents against accidental removal of the cordset.

**Dimensions [mm]**

Snap-in mounting

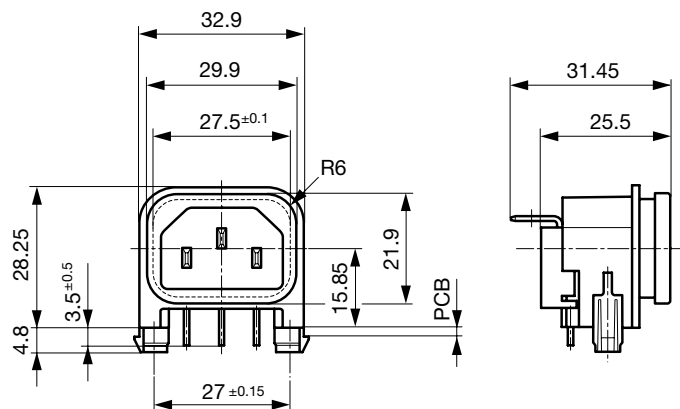

Screw-on mounting

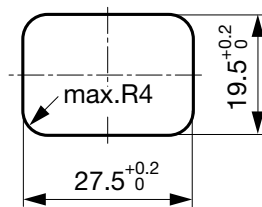
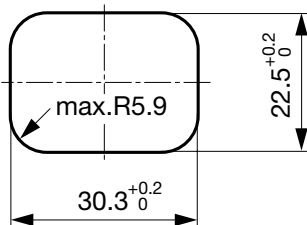
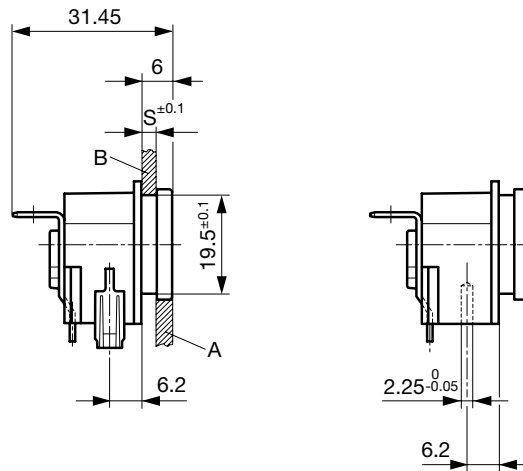

Rear panel mounting

Sandwich mounting

Drilling diagrams

Drilling diagram

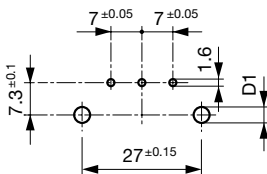

d1 = 6 ± 0.05 for Snap-in mounting  
 d1 = 3.6 ± 0.05 for screw-on mounting  
 with self-tapping screws  
 3 mm (EJOT-PT), 2 screws enclosed

All Variants

Protection Class	PCB mounting	Panel Thickness s [mm]	Ground terminal 4.8 x 0.8 mm	Cover	Order Number
I	Snap-in	1.5	angled to pin axis		GSP2.9205.13
I	Snap-in	1.5	angled to pin axis		GSP2.9901.13
I	Snap-in	1	straight		GSP2.9203.11
I	Snap-in	1.2	straight		GSP2.9203.12
I	Snap-in	1.5	straight		GSP2.9203.13
I	Snap-in	1.5	straight		GSP2.9903.13
I	Snap-in	2	straight		GSP2.9203.14
I	Snap-in	2.5	straight		GSP2.9203.15
I	Snap-in	3	straight		GSP2.9203.16
I	Snap-in	1.5	straight	●	GSP2.9213.13
I	Snap-in	1.5	straight	●	GSP2.9213.1315

Protection Class	PCB mounting	Panel Thickness s [mm]	Ground terminal 4.8 x 0.8 mm	Cover	Order Number
I	Snap-in	1.5	straight	●	GSP2.9213.1321
I	Snap-in	2	straight	●	GSP2.9213.14
I	Snap-in	2.5	straight	●	GSP2.9213.15
I	Snap-in	3	straight	●	GSP2.9213.16
I	Screw	1	straight		GSP2.9103.11
I	Screw	1.5	straight		GSP2.9103.13
I	Screw	2	straight		GSP2.9103.14
I	Screw	2.5	straight		GSP2.9103.15
I	Screw	3	straight		GSP2.9103.16
I	Screw	1.5	straight	●	GSP2.9113.13
I	Screw	2	straight	●	GSP2.9113.14
I	Screw	2.5	straight	●	GSP2.9113.15
I	Screw	3	straight	●	GSP2.9113.16
II	Snap-in	1.5	-		GSP2.9200.13
II	Snap-in	2.5	-		GSP2.9200.15
II	Snap-in	1.5	-	●	GSP2.9210.13
II	Snap-in	2	-	●	GSP2.9210.14
II	Snap-in	2.5	-	●	GSP2.9210.15
II	Snap-in	3	-	●	GSP2.9210.16
II	Screw	1.5	-		GSP2.9100.13
II	Screw	3	-		GSP2.9100.16
II	Screw	2	-	●	GSP2.9110.14
II	Screw	2.5	-	●	GSP2.9110.15

■ Most Popular.

Availability for all products can be searched real-time: <https://www.schurter.com/en/Stock-Check/Stock-Check-SCHURTER>

Articles for enhanced glow wire test requirements acc. IEC 60695-2-12 and -13 can be ordered with ending ".15" (xxxx.xxx.xx15). They are suitable for the use in unattended household equipment acc. IEC 60335-1.

Suffix "21" corresponds to the version with V-Lock mating cordset. The connector is equipped with a notch intended for use with the latching cordset. The cord latching system prevents against accidental removal of the cordset.

Additional version on request, e.g.: Ground terminal straight or quick-connect terminal 6,3 x 0,8 mm

**Packaging unit** 50 Pcs

## Mating Outlets/Connectors

### Category / Description

#### Connector Overview complete



4782 Mounting: Power Cord, 3 x 1 mm <sup>2</sup> / 3 x 18 AWG, Cable, Connector: IEC C13	4782
4022 Mounting: Power Supply Cord, 3 x 1.5 mm <sup>2</sup> , Screw clamps, Connector: IEC C13	4022
4785 Mounting: Power Cord, 3 x 1 mm <sup>2</sup> / 3 x 18 AWG, Cable, Connector: IEC C13	4785
4300-06 Mounting: Power Cord, 3 x 1 mm <sup>2</sup> / 3 x 18 AWG, Cable, Connector: IEC C13	4300-06
4012 Mounting: Power Supply Cord, 3 x 1.5 mm <sup>2</sup> , Screw clamps, Connector: IEC C13	4012

[Connector further types to GSP2](#) ...

#### Interconnection Cord Overview complete



Cord Sets 10 A, Interconnection, 2.0 m, IEC H05VV-F3G1.0, black	6007.0204
Cord Sets 10 A, Interconnection, 1.0 m, Connector IEC C13, H05VV-F3G1.0, black	6007.0212
Cord Sets 10 A, Interconnection, 2.0 m, Connector IEC C13, H05VV-F3G1.0, black	6007.0214

[Interconnection Cord further types to GSP2](#)

Category / Description

[Power Supply Cord Overview complete](#)



Cord Sets 10 A, Europlug, 2.5 m, Connector IEC C13, H05VV-F3G1.0, black	6004.0215
Cord Sets 10 A, Europlug, 2.5 m, Connector IEC C13, H05VV-F3G1.0, black	6003.0215
Cord Sets 10 A, uninsulated wires, 2.0 m, Connector IEC C13, H05VV-F3G1.0, black	6000.0224
Cord Sets 10 A, uninsulated wires, 2.0 m, Connector IEC C13, H05VV-F3G1.0, black	6000.0214
Cord Sets 10 A, United Kingdom, 2.5 m, Connector IEC C13, H05VV-F3G1.0, black	6044.0215
<a href="#">Power Supply Cord further types to GSP2</a>	...

[Power Supply or Interconnection Cord Overview complete](#)



Cord Sets 10 A, United Kingdom, 2.0 m, Connector IEC H05VV-F3G1.0, black	6044.0204
<a href="#">Power Supply or Interconnection Cord further types to GSP2</a>	

Mating Outlets/Connectors shuttered

[Power Cord Overview complete](#)



VAC13KS, Overview, diverse Connector IEC C13, cord end:	VAC13KS
Power cord with IEC connector C17, V-Lock, straight	VAC17KS
<a href="#">Power Cord further types to GSP2</a>	