

SERPAC RB55X14Y16Y 2

Electronic Enclosures

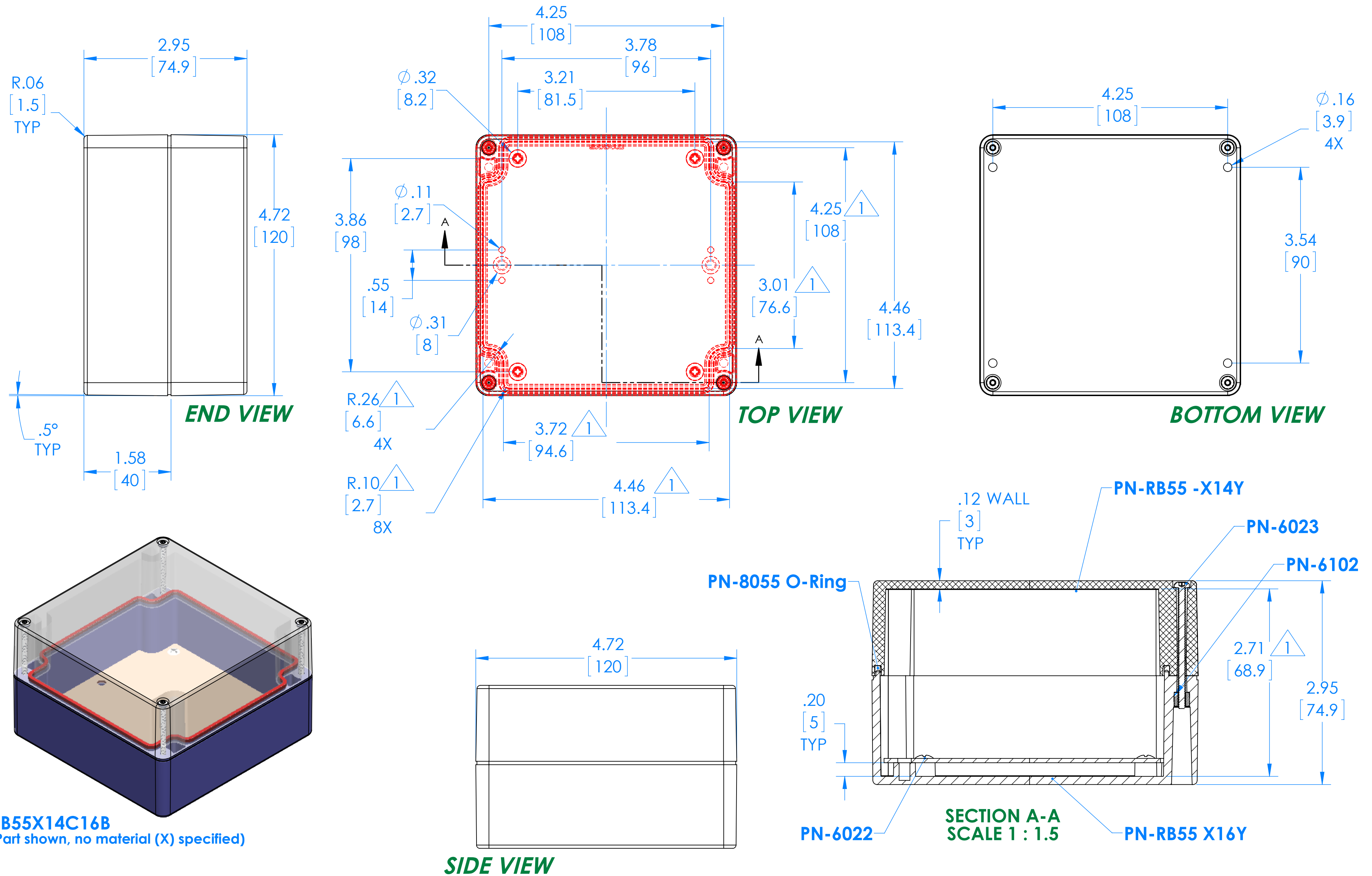

PN	Description
RB55-X14Y	(1) RB55X14Y, Top
RB55X16Y	(1) RB55X16Y, Bottom
8055	(1) RB55 O-Ring
6023	(4) #4-40 Captive Torx Hd Screw
6022	(4) #10 High/Low Pan Hd x 1/4"
6102	(4) #4-40 Threaded Insert

1 =INTERIOR DIMENSIONS (@ BOTTOM)
2 =STANDARD COLORS (Y) ARE: BLACK (B), CLEAR (C) AND GRAY (G)
 TOPS (T) AND BOTTOMS (B). ALL POSSIBLE COMBINATIONS
 STANDARD MATERIALS (X) ARE: POLYCARBONATE (P) AND ABS (A)

-Watertight enclosure meets or exceed Nema 4 and or IP67.

Dimensions represent Polycarbonate material.
 Dim's in Inch
 [mm]

ALL DIMENSIONS ARE ± .010" 7/6/2015
 2009 Wright Street, La Verne, Ca. 91750
 Ph. (626) 331-0517 Fx. (626) 331-8584 serpac.com