

DATE	REV	ECN	APP'D. BY
02-14-08	A0	8358	DHG
04-23-08	A1	8406	DHG
10-30-08	A2	8597	DHG

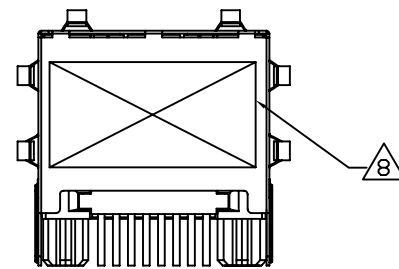

BACK VIEW

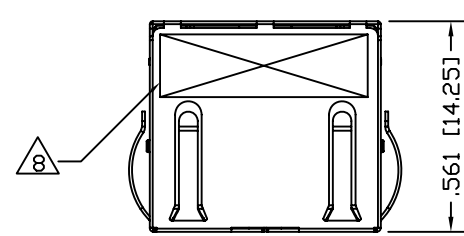
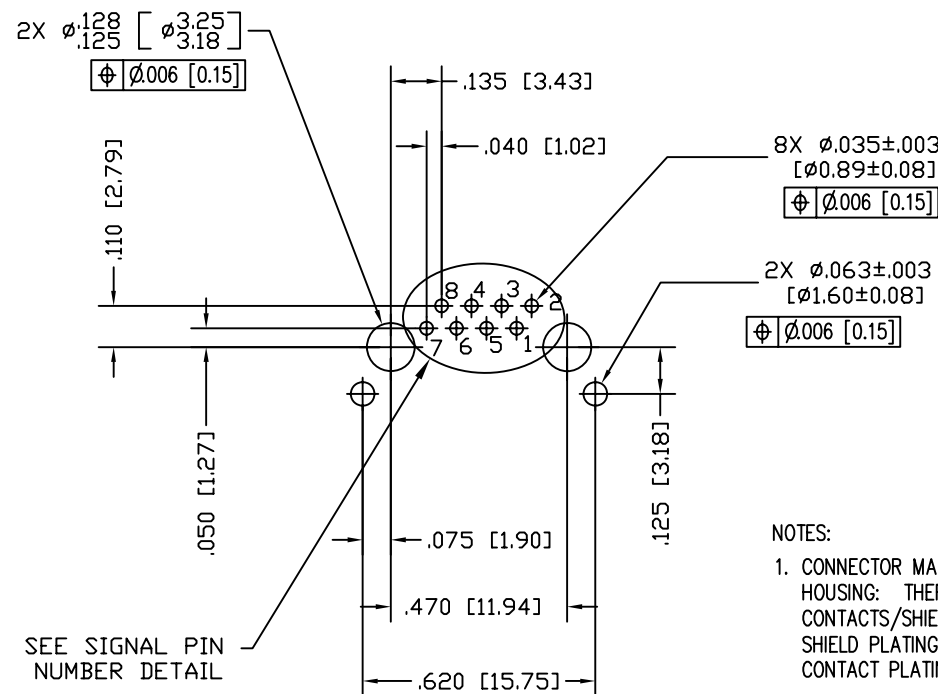
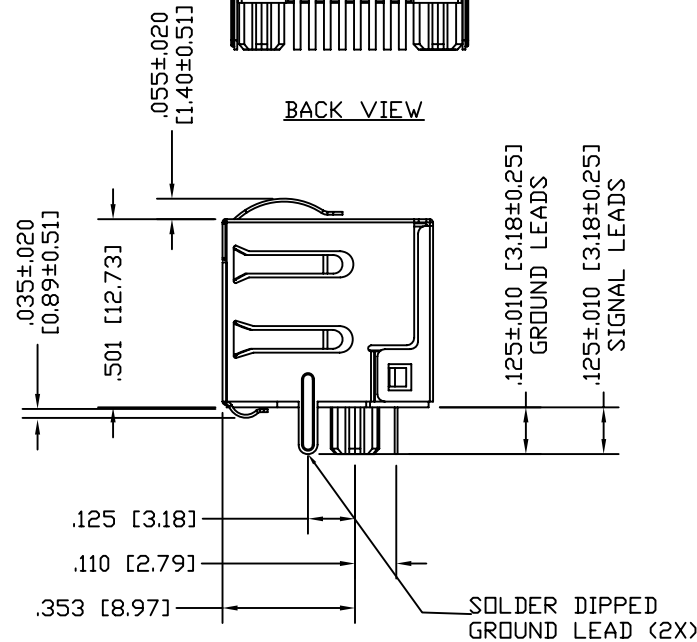
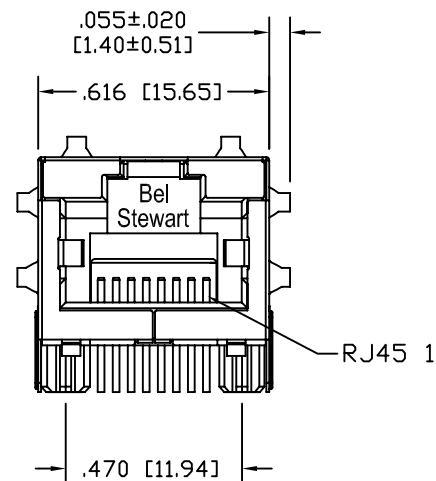

P.C.B. RECOMMENDED HOLE LAYOUT SEEN FROM COMPONENT SIDE

ALL CENTERLINE DIMENSIONS ARE BASIC.

NOTES:

- CONNECTOR MATERIALS:  
HOUSING: THERMOPLASTIC UL94 V-0  
CONTACTS/SHIELD: COPPER ALLOY  
SHIELD PLATING: NICKEL OR TIN  
CONTACT PLATING: SELECTIVE GOLD IN CONTACT AREA  
SEE CHART FOR PART NUMBER
- DESIGNED FOR 10 GIGABIT APPLICATIONS.
- DIMENSIONS AND TOLERANCES COMPLY WITH FCC/CFR 47, PART 68.
- THE SUGGESTED PANEL OPENING IS INTENDED TO GIVE USER THE ABILITY TO HAVE REASONABLE JACK/PANEL CLEARANCES, YET MAINTAIN GROUNDING CAPABILITY. THESE VARIABLES CAN BE ADJUSTED IN EITHER DIRECTION BUT MAY CARRY SOME CONSEQUENCES IN THE FORM OF LOWER MATING FORCES OR TIGHTER ASSEMBLY TOLERANCES.
- DIELECTRIC WITHSTANDING VOLTAGE ( CONTACT TO SHIELD ) : 2250VDC
- HIGH TEMPERATURE PLASTIC; IR REFLOW COMPATIBLE FOR 260°C
- FOR PRODUCT SPECIFICATION SEE PR026-01
- LOGO, PART NUMBER AND DATE CODE LOCATED APROX. IN THIS AREA.
- FOR PROPER JACK FUNCTION AND PERFORMANCE, TIA-1096 COMPLIANT PLUGS MUST BE USED.

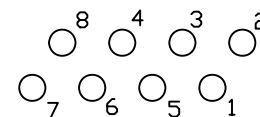

SIGNAL PIN NUMBER DETAIL

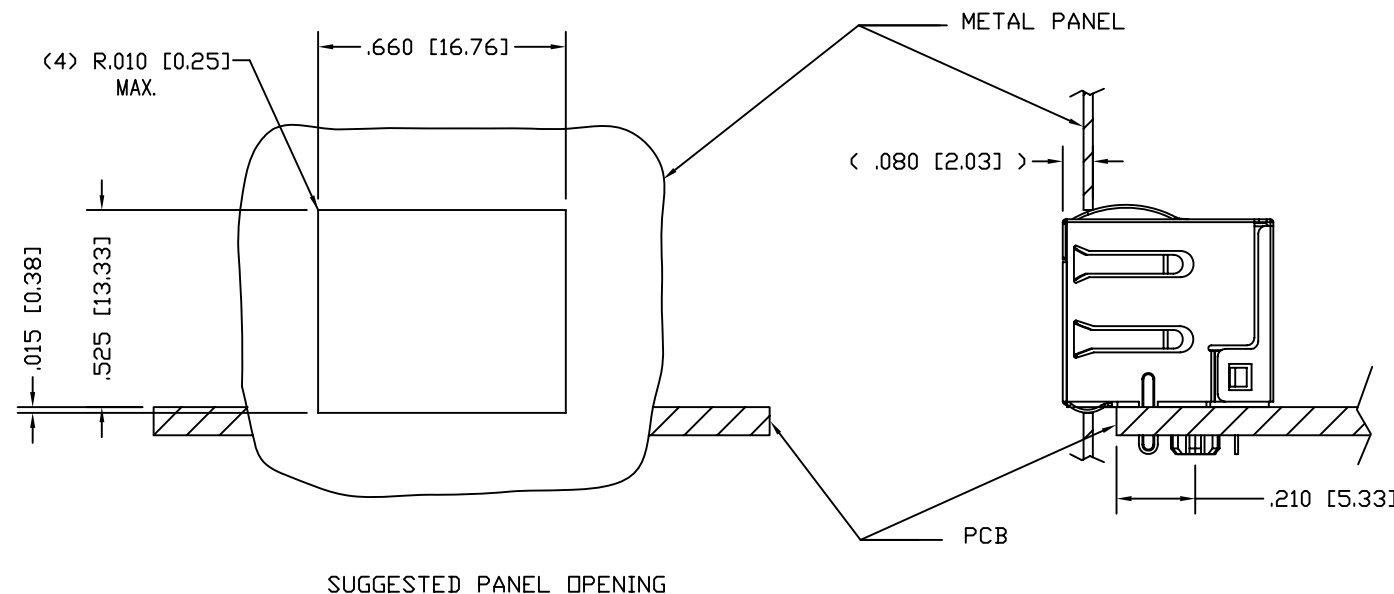

SUGGESTED PANEL OPENING

50 MICRO-INCHES [1.27um]	SS-60300-010
CONTACT PLATING IN MATING AREA	PART NUMBER

THIRD ANGLE PROJECTION

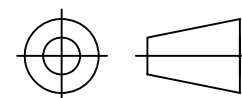

DO NOT SCALE DRAWING  
DRAWING IS SUBJECT TO CHANGE WITHOUT NOTICE

DIMENSIONS: INCHES [METRIC]

UNLESS OTHERWISE SPECIFIED TOLERANCES ARE ±.005 [0.13] ANGLES ARE ± 1°

SHEET NO. 1 OF 1

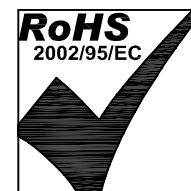

# Bel Stewart Connector

11118 Susquehanna Trail South  
Glen Rock, PA 17327-9199  
(717) 235-7512 Fax: (717) 235-7954 <http://www.stewartconnector.com>

TITLE: LOW PROFILE, HORIZONTAL SHIELDED JACK WITH PANEL GROUNDS, NO COMPENSATION

THIS DRAWING AND THE SUBJECT MATTER SHOWN THEREON ARE CONFIDENTIAL AND THE PROPRIETARY PROPERTY OF OF STEWART AND SHALL NOT BE REPRODUCED, COPIED OR USED IN ANY MANNER WITHOUT PRIOR WRITTEN CONSENT OF STEWART. THE SUBJECT MATTER MAY BE PATENTED OR A PATENT MAY BE PENDING.

DRN BY: DHG	DATE 12-01-06
APPD BY: TRM	DATE 12-01-06
DWG NO. CT600045	REV. A2