

DATE	REV	ECN	APP'D. BY
7-24-17	A1	11049	TRM
8-11-17	A2	11061	TRM

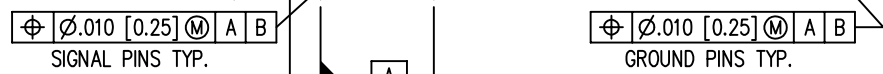

30 MICRO-INCHES [0.76um]	SS-79100-012	WITH LIGHT PIPE
30 MICRO-INCHES [0.76um]	SS-79100-011	WITHOUT LIGHT PIPE
CONTACT PLATING IN MATING AREA	PART NUMBER	

- NOTES:
- MATERIALS:  
 CONTACT: PHOSPHOR BRONZE  
 CONNECTOR HOUSING: LCP UL 94V-0 COLOR: BLACK  
 MOLDED INSERT: HIGH TEMP PLASTIC UL 94V-0 COLOR: BLACK  
 CAGE: COPPER ALLOY  
 LIGHT PIPES: POLYCARBONATE UL 94V-0 COLOR: CLEAR  
 LIGHT PIPE HOUSING: PBT UL 94V-0 COLOR: BLACK  
 EMI SPRINGS: COPPER ALLOY
  - PLATING:  
 PCB PINS: 0.0001 [2.54um] MINIMUM MATTE TIN  
 OVER 0.00005 [1.27um] MINIMUM NICKEL  
 CAGE: NICKEL
  - TEMPERATURE:  
 OPERATIONAL: -40°C~+85°C  
 STORAGE: -55°C~+105°C
  - FOR PRODUCT SPECIFICATIONS SEE PR043-01.
  - MATES WITH SFP MSA COMPLIANT TRANSCEIVERS.

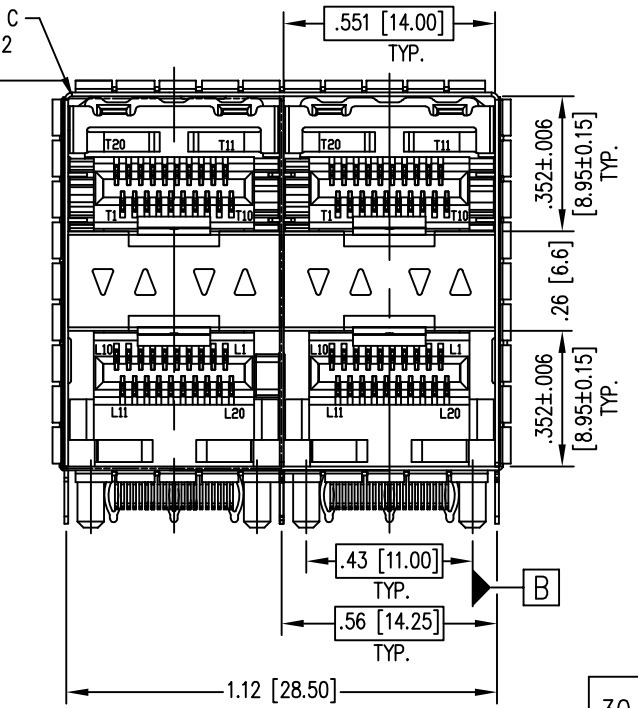
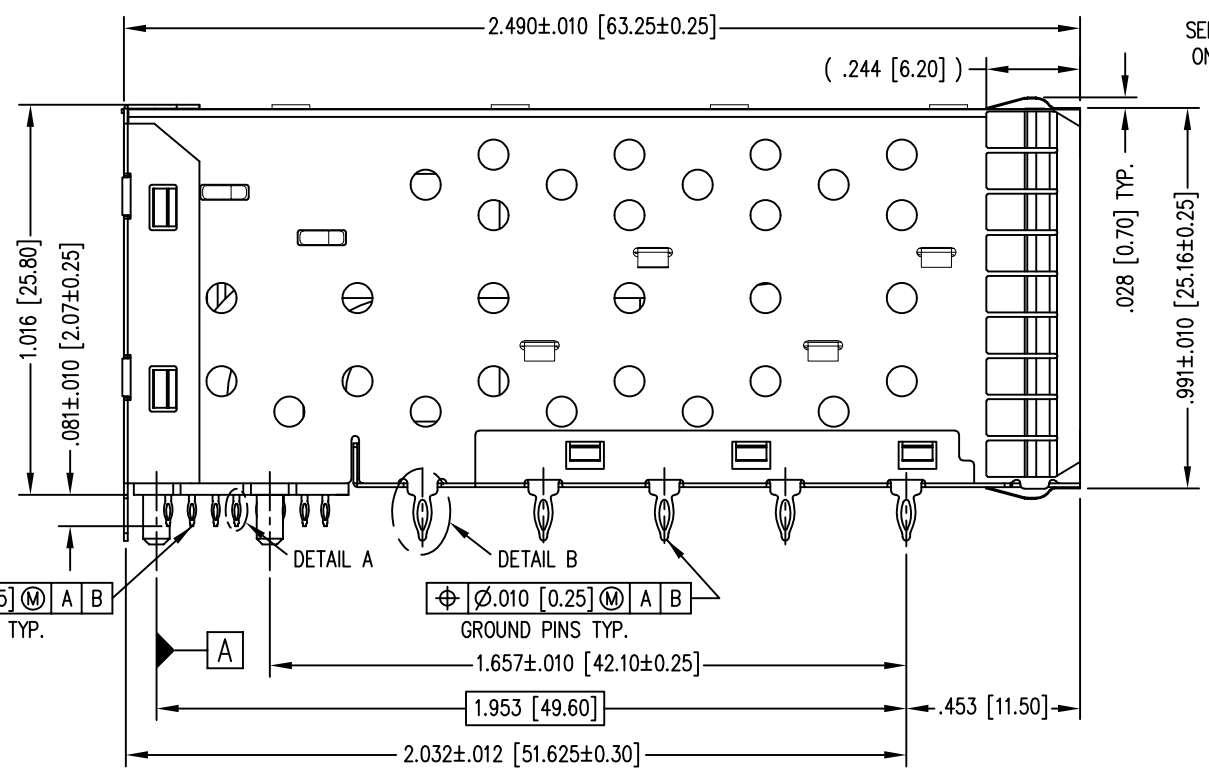
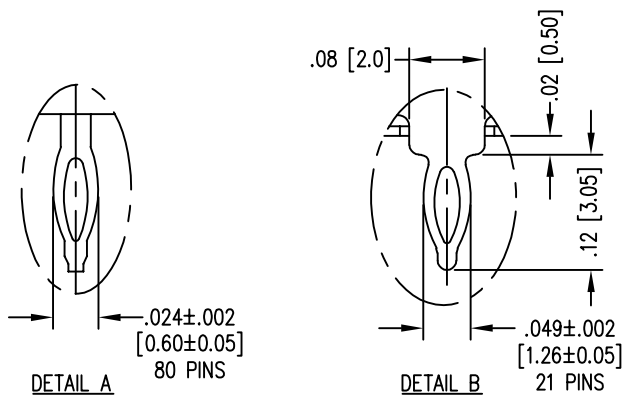
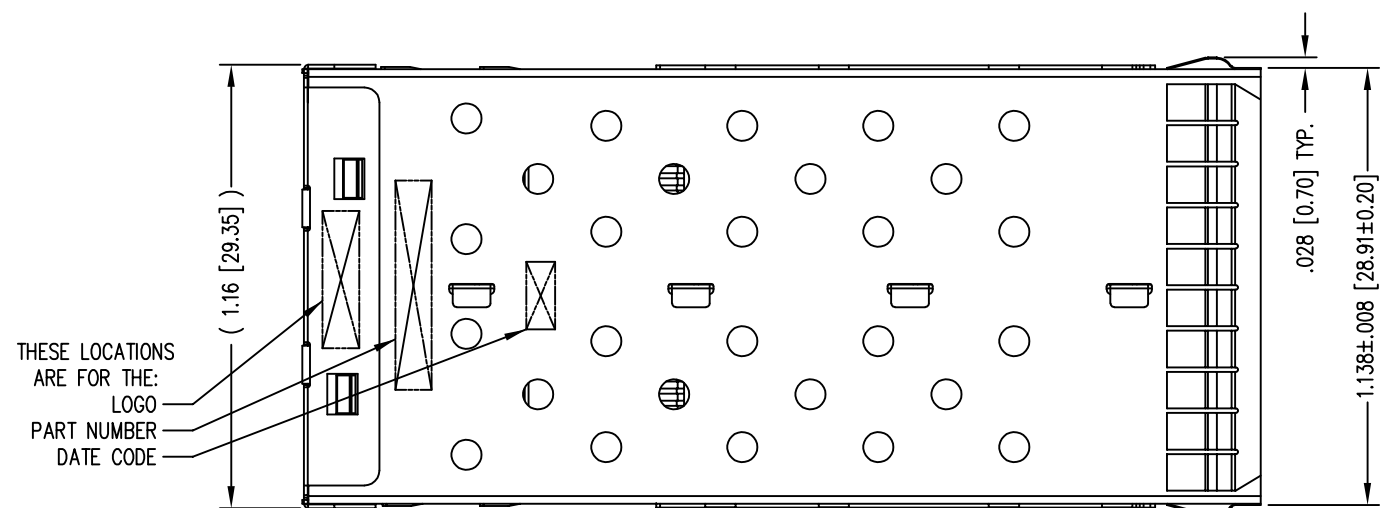

THIRD ANGLE PROJECTION

DRAWING IS SUBJECT TO CHANGE WITHOUT NOTICE

UNLESS OTHERWISE SPECIFIED DIMENSIONS INCHES [METRIC] TOLERANCES ARE:

ANGLES ± 2°

1 PLC. DEC. ±.010" [±0.25]

2 PLC. DEC. ±.005" [±0.13]

3 PLC. DEC. ±.004" [±0.10]

DO NOT SCALE DRAWING

SHEET NO. 1 OF 4

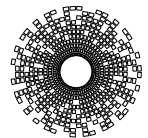

**stewart**  
 CONNECTOR  
 a bel group

1118 Susquehanna Trail South  
 Glen Rock, PA 17327-9199  
 (717) 235-7512  
<http://www.stewartconnector.com>

TITLE: SFP+ 2X2 CAGE WITH EMI CLIP, PRESS FIT  
 SFP+ 2X2 CAGE W/LIGHT PIPES, PRESS FIT

THIS DRAWING AND THE SUBJECT MATTER SHOWN THEREON ARE CONFIDENTIAL AND THE PROPRIETARY PROPERTY OF STEWART CONNECTOR AND SHALL NOT BE REPRODUCED, COPIED, OR USED IN ANY MANNER WITHOUT PRIOR WRITTEN CONSENT OF STEWART CONNECTOR. ONE OR MORE U.S. PATENTS MAY APPLY TO THIS PRODUCT. FOR DETAILS, PLEASE VISIT: [HTTP://BELFUSE.COM/STEWART/STEWART\\_PATENTS/](http://BELFUSE.COM/STEWART/STEWART_PATENTS/)

DRN BY: TRM	DATE: 6-14-17
APPD BY: DHG	DATE: 6-30-17
DWG NO. CT790011	REV. A2

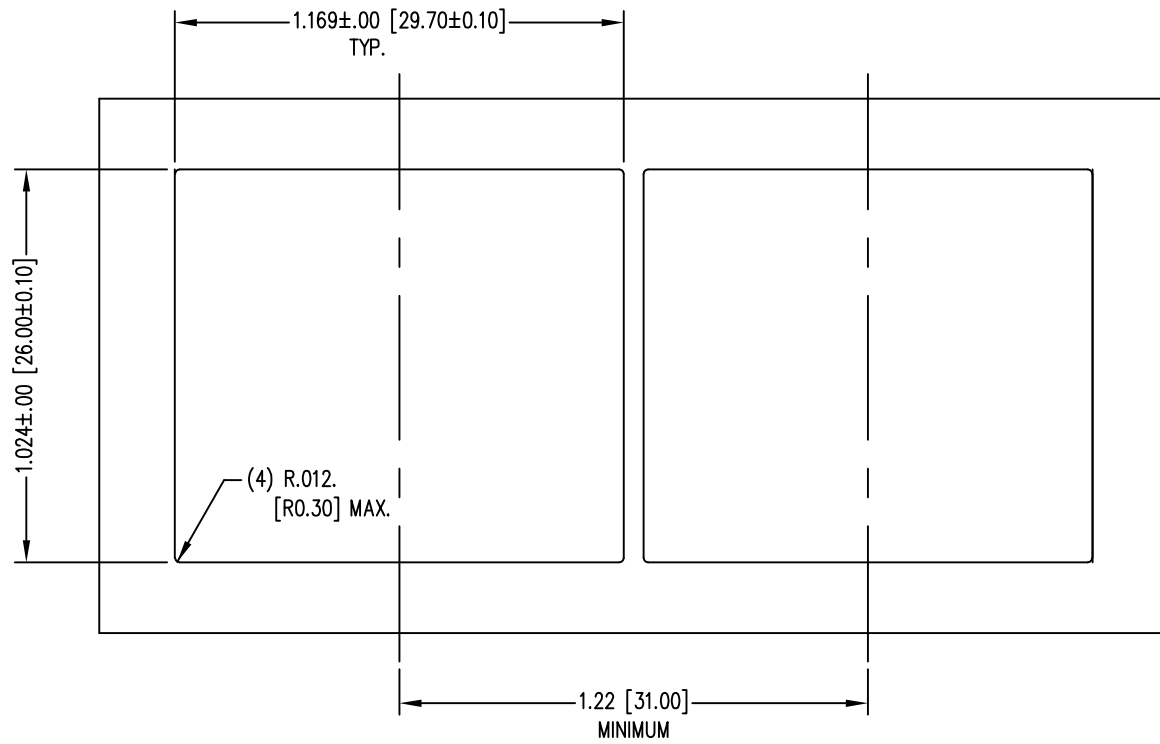

BEZEL CUT-OUT CENTER SPACING DETAIL  
BEZEL THICKNESS: .03 [0.8] - .10 [2.6]

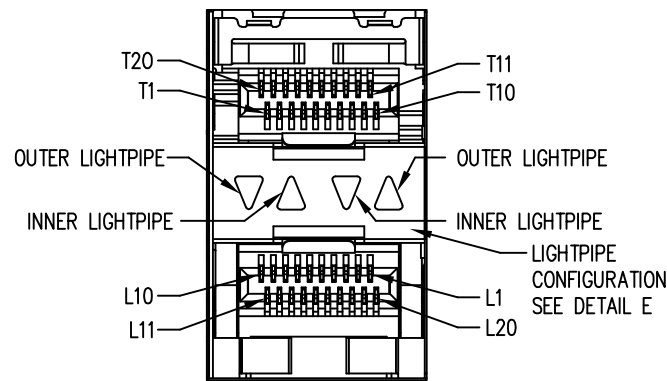
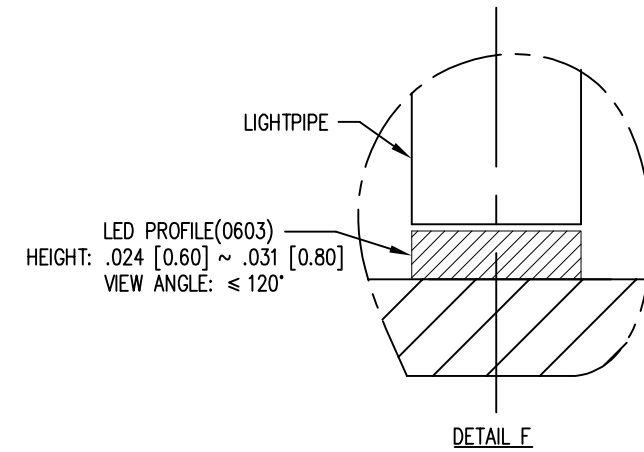
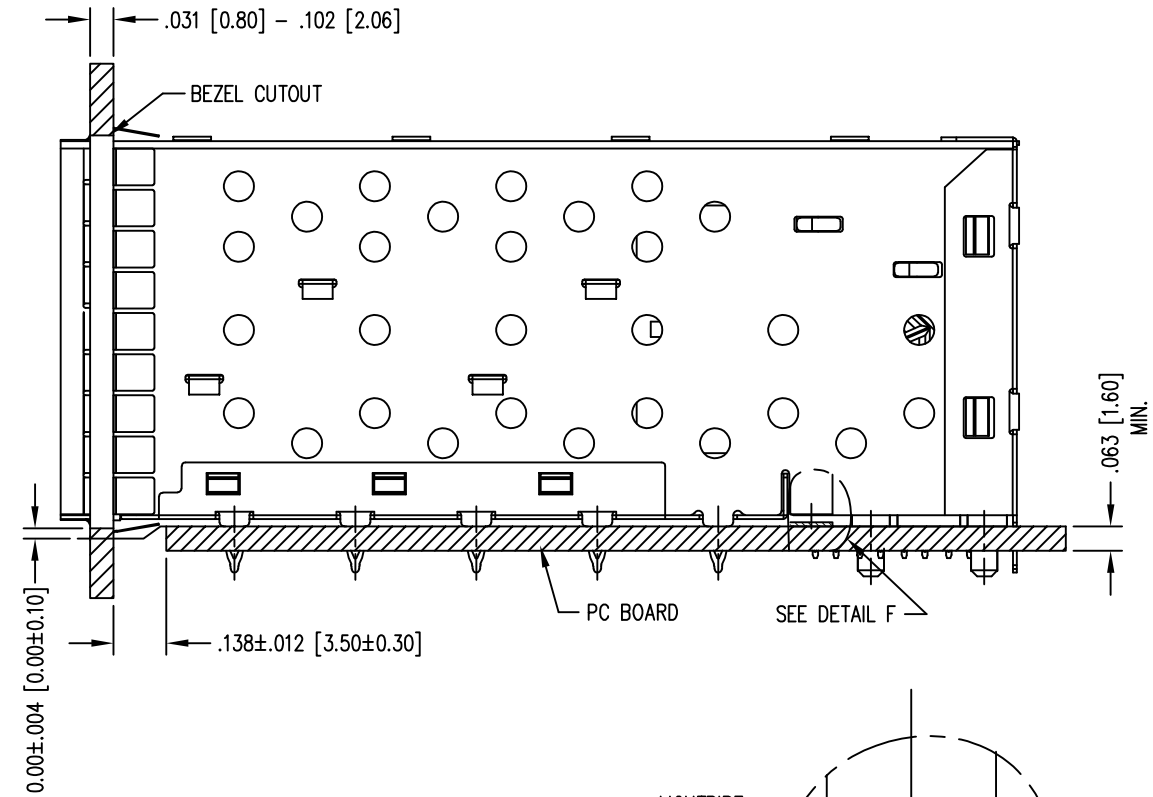

DETAIL C

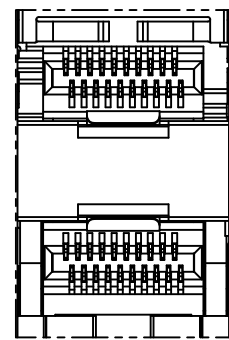

NO LIGHTPIPES  
SS-79100-011

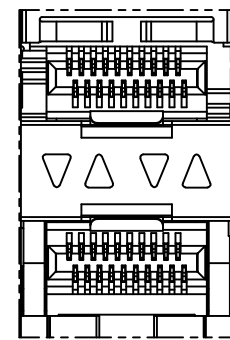

4 LIGHTPIPES  
SS-79100-012

DETAIL E



THIRD ANGLE PROJECTION

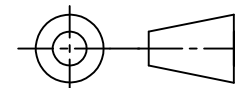

DRAWING IS SUBJECT TO CHANGE WITHOUT NOTICE

UNLESS OTHERWISE SPECIFIED DIMENSIONS INCHES [METRIC] TOLERANCES ARE:

- ANGLES ± 2°
  - 1 PLC. DEC. ±.010" [±0.25]
  - 2 PLC. DEC. ±.005" [±0.13]
  - 3 PLC. DEC. ±.004" [±0.10]
- DO NOT SCALE DRAWING

SHEET NO. 2 OF 4

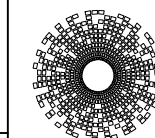

**stewart**  
CONNECTOR  
a bel group

1118 Susquehanna Trail South  
Glen Rock, PA 17327-9199  
(717) 235-7512

<http://www.stewartconnector.com>

TITLE: SFP+ 2X2 CAGE WITH EMI CLIP, PRESS FIT  
SFP+ 2X2 CAGE W/LIGHT PIPES, PRESS FIT

THIS DRAWING AND THE SUBJECT MATTER SHOWN THEREON ARE CONFIDENTIAL AND THE PROPRIETARY PROPERTY OF STEWART CONNECTOR AND SHALL NOT BE REPRODUCED, COPIED, OR USED IN ANY MANNER WITHOUT PRIOR WRITTEN CONSENT OF STEWART CONNECTOR. ONE OR MORE U.S. PATENTS MAY APPLY TO THIS PRODUCT. FOR DETAILS, PLEASE VISIT: [HTTP://BELFUSE.COM/STEWART/STEWART\\_PATENTS/](http://BELFUSE.COM/STEWART/STEWART_PATENTS/)

DRN BY:	TRM	DATE	6-14-17
APPD BY:	DHG	DATE	6-30-17
DWG NO.	CT790011	REV.	A2

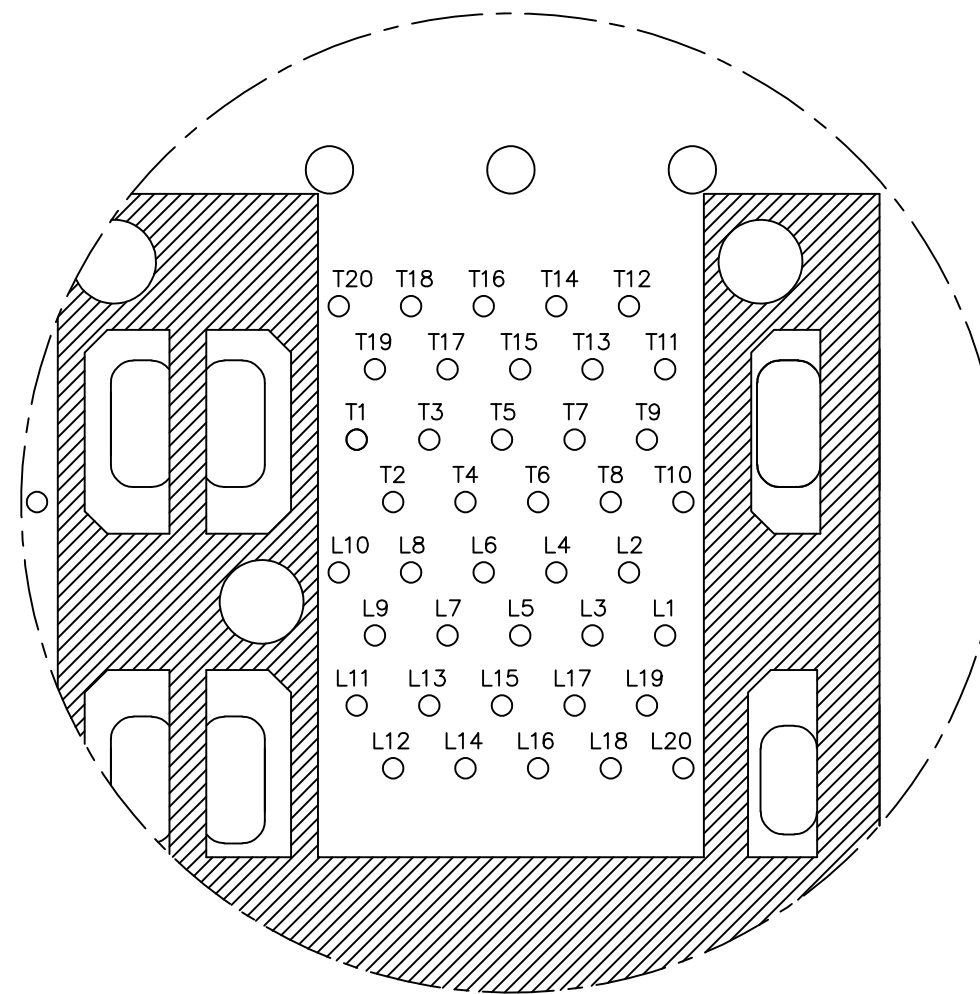
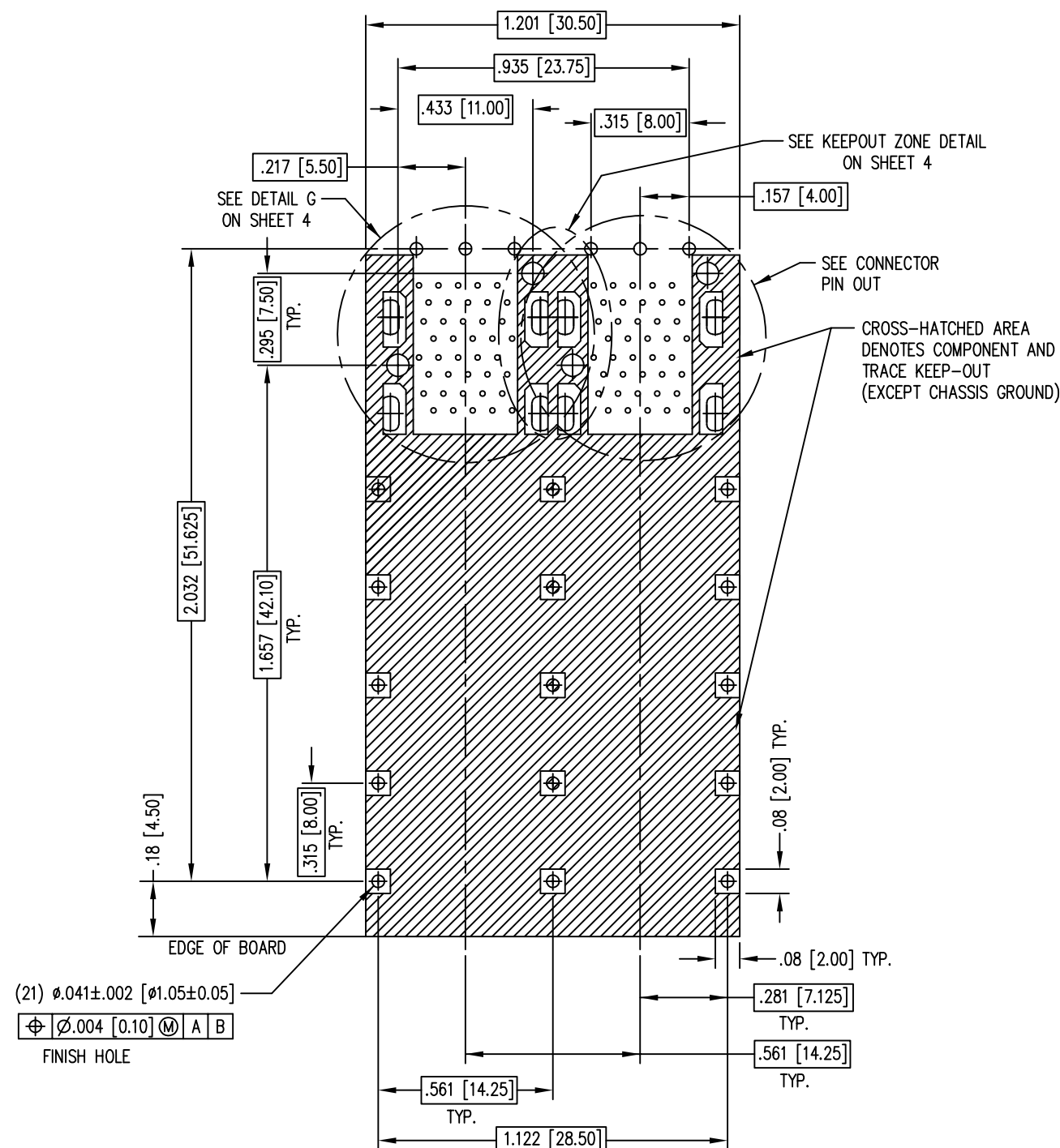

CONNECTOR PIN-OUT  
COMPONENT SIDE OF BOARD

RECOMMENDED PCB LAYOUT - COMPONENT SIDE  
 RECOMMENDED PCB THICKNESS - .104 [2.63]  
 THE ENTIRE AREA OF THE CONNECTOR FOOTPRINT  
 TO BE CONSIDERED THE KEEP OUT AREA FOR COMPONENTS  
 (OTHER THAN LIGHTPIPE LEADS)  
 THIS AREA IS INDICATED BY THE DASHED LINE



THIRD ANGLE PROJECTION 	<b>stewart</b> CONNECTOR a bel group	1118 Susquehanna Trail South Glen Rock, PA 17327-9199 (717) 235-7512 <a href="http://www.stewartconnector.com">http://www.stewartconnector.com</a>		
		TITLE: SFP+ 2X2 CAGE WITH EMI CLIP, PRESS FIT SFP+ 2X2 CAGE W/LIGHT PIPES, PRESS FIT		
DRAWING IS SUBJECT TO CHANGE WITHOUT NOTICE UNLESS OTHERWISE SPECIFIED DIMENSIONS INCHES [METRIC] TOLERANCES ARE: ANGLES ± 2° 1 PLC. DEC. ±.010" [±0.25] 2 PLC. DEC. ±.005" [±0.13] 3 PLC. DEC. ±.004" [±0.10] DO NOT SCALE DRAWING	THIS DRAWING AND THE SUBJECT MATTER SHOWN THEREON ARE CONFIDENTIAL AND THE PROPRIETARY PROPERTY OF STEWART CONNECTOR AND SHALL NOT BE REPRODUCED, COPIED, OR USED IN ANY MANNER WITHOUT PRIOR WRITTEN CONSENT OF STEWART CONNECTOR. ONE OR MORE U.S. PATENTS MAY APPLY TO THIS PRODUCT. FOR DETAILS, PLEASE VISIT: <a href="http://BELFUSE.COM/STEWART/STEWART_PATENTS/">HTTP://BELFUSE.COM/STEWART/STEWART_PATENTS/</a>		DRN BY: TRM APPD BY: DHG DWG NO. CT790011	DATE 6-14-17 DATE 6-30-17 REV. A2
SHEET NO. 3 OF 4				

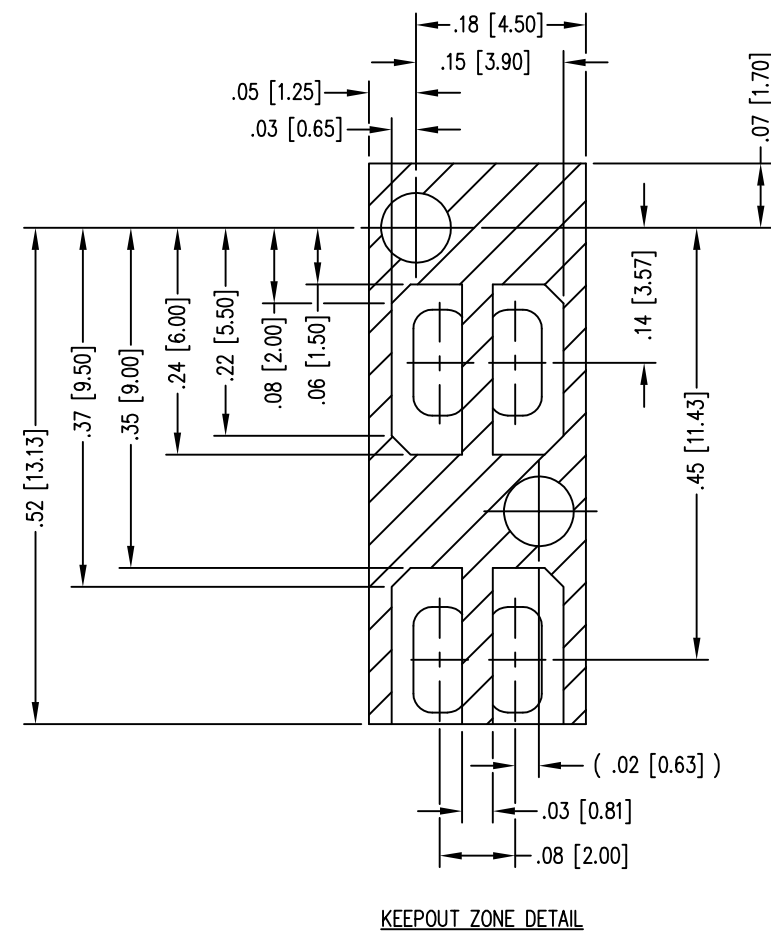
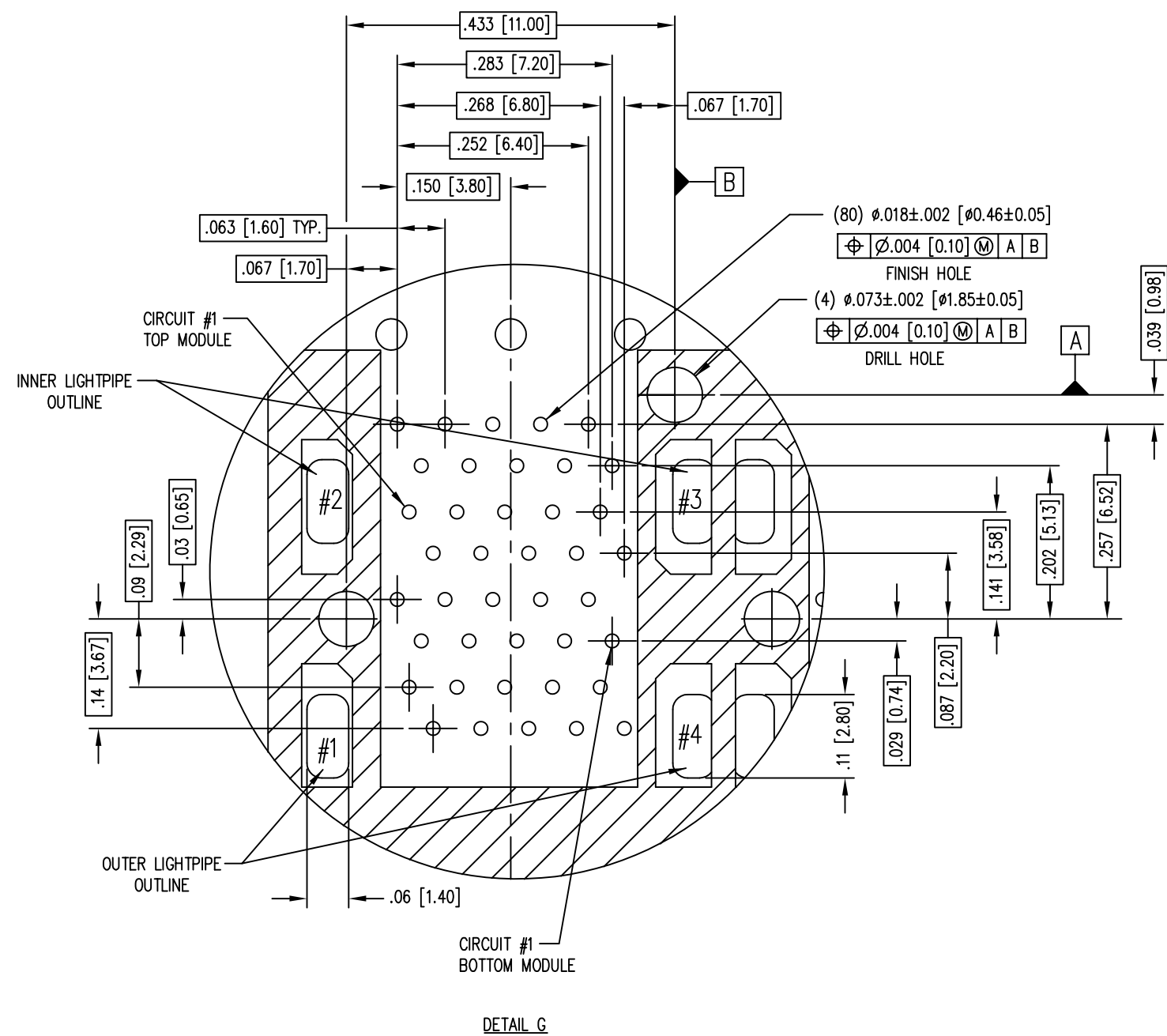

<p>THIRD ANGLE PROJECTION</p> <p>DRAWING IS SUBJECT TO CHANGE WITHOUT NOTICE</p> <p>UNLESS OTHERWISE SPECIFIED DIMENSIONS INCHES [METRIC]</p> <p>TOLERANCES ARE:</p> <p>ANGLES ± 2°</p> <p>1 PLC. DEC. ± 0.010" [±0.25]</p> <p>2 PLC. DEC. ± 0.005" [±0.13]</p> <p>3 PLC. DEC. ± 0.004" [±0.10]</p> <p>DO NOT SCALE DRAWING</p> <p>SHEET NO. 4 OF 4</p>	<p>1118 Susquehanna Trail South Glen Rock, PA 17327-9199 (717) 235-7512 <a href="http://www.stewartconnector.com">http://www.stewartconnector.com</a></p>	<p>TITLE: SFP+ 2X2 CAGE WITH EMI CLIP, PRESS FIT SFP+ 2X2 CAGE W/LIGHT PIPES, PRESS FIT</p>	
		<p>THIS DRAWING AND THE SUBJECT MATTER SHOWN THEREON ARE CONFIDENTIAL AND THE PROPRIETARY PROPERTY OF STEWART CONNECTOR AND SHALL NOT BE REPRODUCED, COPIED, OR USED IN ANY MANNER WITHOUT PRIOR WRITTEN CONSENT OF STEWART CONNECTOR. ONE OR MORE U.S. PATENTS MAY APPLY TO THIS PRODUCT. FOR DETAILS, PLEASE VISIT: <a href="http://BELFUSE.COM/STEWART/STEWART_PATENTS/">HTTP://BELFUSE.COM/STEWART/STEWART_PATENTS/</a></p>	<p>DRN BY: TRM</p> <p>APPD BY: DHG</p> <p>DWG NO. CT790011</p>