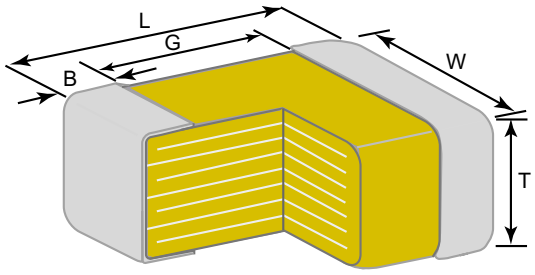
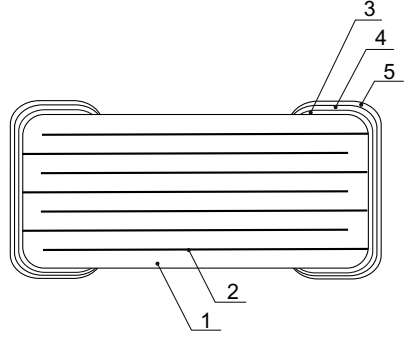

TDK MLCC Datasheet¹

TDK P/N

C1005	C0G	1H	390	J	T	XXXX
1)	2)	3)	4)	5)	6)	7)

No.	Segment	Detail	Comments
1	Case Size	1.0 x 0.5 mm	See below for dimensions.
2	Temperature Characteristics	-55+125°C 0 ± 30 ppm/ C	Class I ; Conforms to EIA 198
3	Rated Voltage	50 V	DC
4	Capacitance	39 pF	1.0 ± 0.2 Vrms , 1MHz ± 10%
5	Capacitance Tolerance	± 5%	Conforms to IEC 384-9
6	Packaging Style	Tape and Reel, 8 mm	EIA 481 Format
7	TDK internal Code	XXXX	(Internal TDK use only)
-	Quality Factor (Q)	2000 min.	1.0 ± 0.2 Vrms , 1MHz ± 10%
-	Insulation Resistance	100,000 MΩ min.	apply rated voltage for 60s

Physical Dimensions		Material System																																																													
																																																															
<table border="1"> <thead> <tr> <th>Symbol</th> <th>Dimensions (mm)</th> </tr> </thead> <tbody> <tr> <td>L</td> <td>1.0 ± 0.05</td> </tr> <tr> <td>W</td> <td>0.5 ± 0.05</td> </tr> <tr> <td>T</td> <td>0.55 max</td> </tr> <tr> <td>B</td> <td>0.15 min.</td> </tr> <tr> <td>G</td> <td>0.35 min.</td> </tr> </tbody> </table>		Symbol	Dimensions (mm)	L	1.0 ± 0.05	W	0.5 ± 0.05	T	0.55 max	B	0.15 min.	G	0.35 min.	<table border="1"> <thead> <tr> <th rowspan="2">No.</th> <th rowspan="2">Name</th> <th colspan="4">Material</th> </tr> <tr> <th colspan="2">Class I</th> <th colspan="2">Class II</th> </tr> <tr> <td></td> <td></td> <td>Pd</td> <td>TME</td> <td>Pd</td> <td>TME</td> </tr> </thead> <tbody> <tr> <td>1</td> <td>Dielectric</td> <td>TiO2</td> <td>CaZrO3</td> <td colspan="2">BaTiO3</td> </tr> <tr> <td>2</td> <td>Electrode</td> <td>Pd</td> <td>Ni</td> <td>Pd</td> <td>Ni</td> </tr> <tr> <td>3</td> <td rowspan="3">Termination</td> <td>Ag or Ag/Pd</td> <td>Cu</td> <td>Ag or Ag/Pd</td> <td>Cu</td> </tr> <tr> <td>4</td> <td colspan="4">Ni</td> </tr> <tr> <td>5</td> <td colspan="4">Sn</td> </tr> </tbody> </table>						No.	Name	Material				Class I		Class II				Pd	TME	Pd	TME	1	Dielectric	TiO2	CaZrO3	BaTiO3		2	Electrode	Pd	Ni	Pd	Ni	3	Termination	Ag or Ag/Pd	Cu	Ag or Ag/Pd	Cu	4	Ni				5	Sn			
Symbol	Dimensions (mm)																																																														
L	1.0 ± 0.05																																																														
W	0.5 ± 0.05																																																														
T	0.55 max																																																														
B	0.15 min.																																																														
G	0.35 min.																																																														
No.	Name	Material																																																													
		Class I		Class II																																																											
		Pd	TME	Pd	TME																																																										
1	Dielectric	TiO2	CaZrO3	BaTiO3																																																											
2	Electrode	Pd	Ni	Pd	Ni																																																										
3	Termination	Ag or Ag/Pd	Cu	Ag or Ag/Pd	Cu																																																										
4		Ni																																																													
5		Sn																																																													

¹ This datasheet gives a basic overview of the multilayer ceramic capacitor as defined in the above TDK part number. A full specification (including part number construction, available capacitance ranges, packaging and caution notes) is available upon request. The information above is subject to change by TDK without any notice.