

1-1586019-6 Product Details

[Share](#) [Print](#) [Email](#)

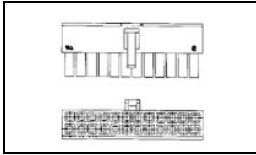

1-1586019-6

TE Internal Number: 1-1586019-6

Active

[View 3D PDF](#)

VAL-U-LOK Series Connector System

Always EU RoHS/ELV Compliant (Statement of Compliance)

Product Highlights:

- Wire-to-Board, Wire-to-Board / Wire-to-Wire, Wire-to-Wire
- Applies To Wire/Cable
- Connector
- Glow Wire Rating = Standard Part - Not Glow Wire
- Housing

[View all Features](#)

Quick Links

- ▶ [Pricing & Availability](#)
- ▶ [Search for Tooling](#)
- ▶ [View Mating Products \(9\)](#)
- ▶ [Product Feature Selector](#)
- ▶ [Contact Us About This Product](#)

[Add to My Part List](#)

[Request Sample](#)

[Find Similar Products](#)

[Buy Product](#)

Documentation & Additional Information

Product Drawings:

- [RECEPTACLE HOUSING, V0, VAL-U-LOK\(TM\)](#) (PDF, English)

Catalog Pages/Data Sheets:

- [SOFT_SHELL_PIN_AND_SOCKET_CONNECTORS_CATALOG](#) (PDF, English)

Product Specifications:

- [VAL-U-LOK Connectors](#) (PDF, English)

Application Specifications:

- [VAL-U-LOK Series Headers and Connectors](#) (PDF, English)

Instruction Sheets:

- None Available

CAD Files: [\(CAD Format & Compression Information\)](#)

- [2D Drawing](#) (DXF, Version C)
- [3D Model](#) (IGES, Version C)
- [3D Model](#) (STEP, Version C)

[List all Documents](#)

Related Products:

- [Tooling](#)
- [Mating Products \(9\)](#)

Product Features (Please use the Product Drawing for all design activity)

Product Type Features:

- Product Type = Connector
- Connector Type = Housing
- Termination Method to Wire/Cable = Crimp
- Sealed = No
- UL File Number = E28476
- CSA File Number = 208567

Mechanical Attachment:

- Mating Retention Type = Latching

Electrical Characteristics:

- Contact Current Rating, Max. (A) = 9
- Operating Voltage Reference = AC
- Operating Voltage (VAC) = 600

Dimensions:

- Length (X-Axis) (mm [in]) = 34.80 [1.3701]
- Width (Z-Axis) (mm [in]) = 20.00 [0.787]
- Profile Height (Y-Axis) (mm [in]) = 11.80 [0.464]

Body Features:

- Mating Retention = With
- Selectively Loaded = No

Contact Features:

- Contact Type = Socket
- Contact Design = Dual Beam

Housing Features:

- Connector Style = Receptacle
- Centerline (mm [in]) = 4.20 [0.165]
- Mating Alignment = With
- Mating Alignment Type = Keyed
- Housing Color = Natural
- UL Flammability Rating = UL 94V-0

Configuration Features:

- Number of Positions = 16
- Number of Rows = 2

Industry Standards:

- [RoHS/ELV Compliance](#) = RoHS compliant, ELV compliant
- [Lead Free Solder Processes](#) = Not relevant for lead free process
- RoHS/ELV Compliance History = Always was RoHS compliant
- Agency/Standard = CSA, UL
- UL Rating = Recognized

Identification Marking:

- Circuit Identification Feature = With

Environmental:

- Operating Temperature (°C [°F]) = -40 - +105 [-40 - +221]

Conditions for Usage:

- Applies To = Wire/Cable
- Glow Wire Rating = Standard Part - Not Glow Wire

Operation/Application:

- Application Use = Wire-to-Board, Wire-to-Board / Wire-to-Wire, Wire-to-Wire
- Contact Transmits (Typical Application) = Signal (Data)
- Pick and Place Cover = Without

Packaging Features:

- Packaging Method = Bag

Other:

- Brand = AMP

THIS DRAWING IS UNPUBLISHED. RELEASED FOR PUBLICATION
 © COPYRIGHT - By - ALL RIGHTS RESERVED.

LOC		DIST		REVISIONS			
P	LTR	DESCRIPTION		DATE	DWN	APVD	
CM	00	C		REVISED PER ECO-12-014543	07NOV12	KH SM	

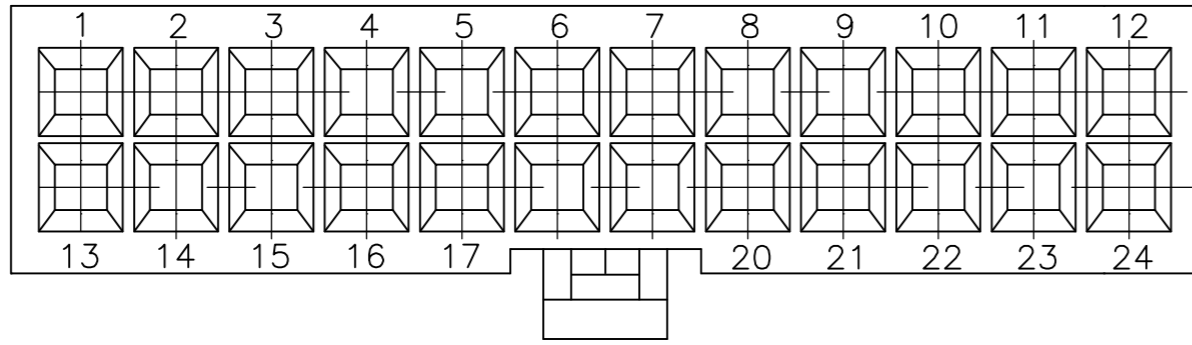

1 MATERIAL: NYLON, UL94V-0.

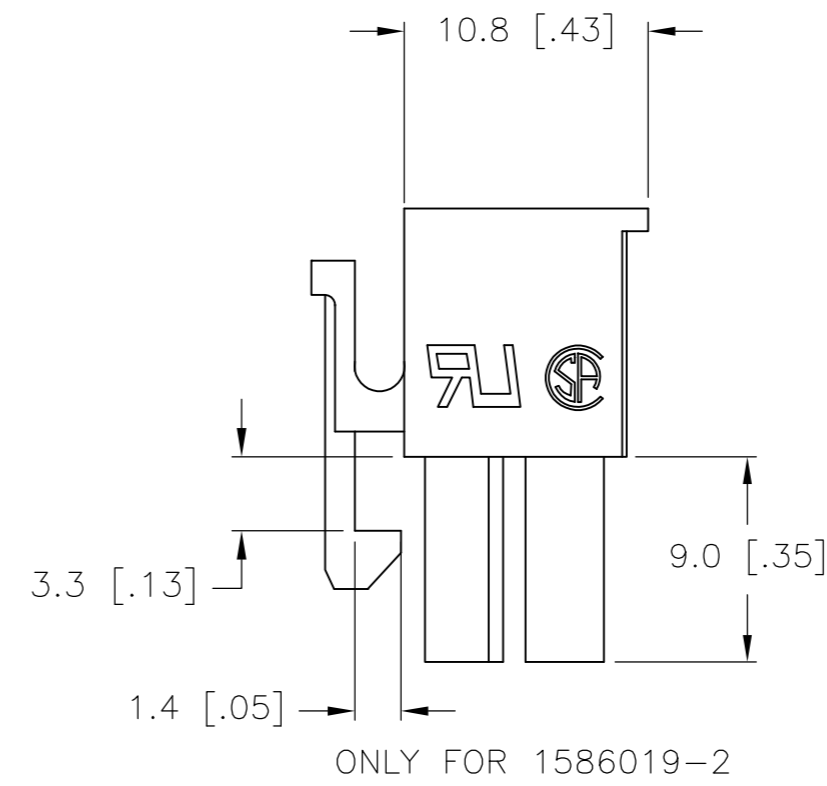
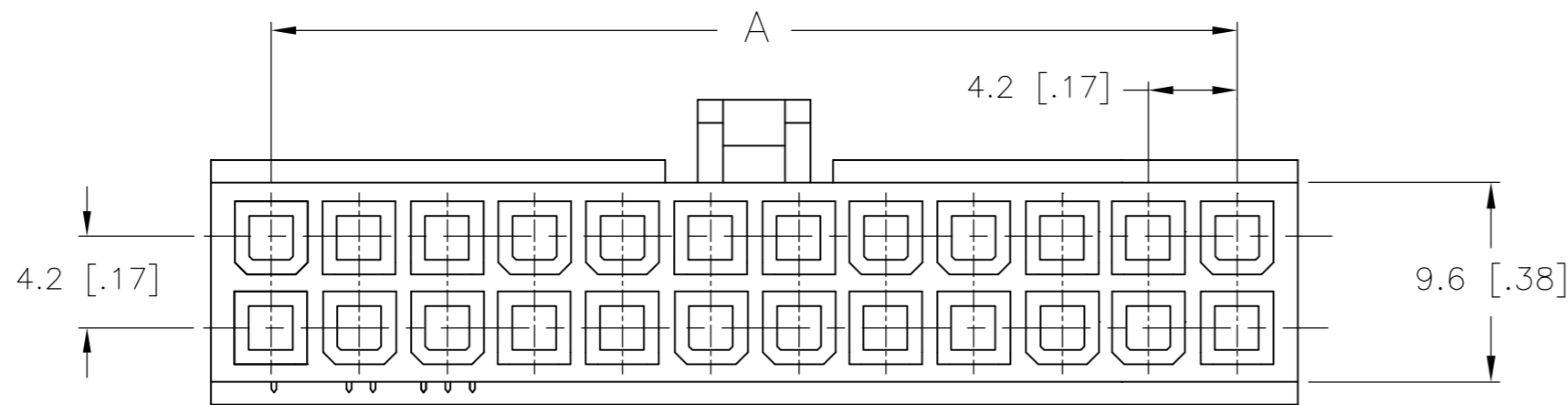
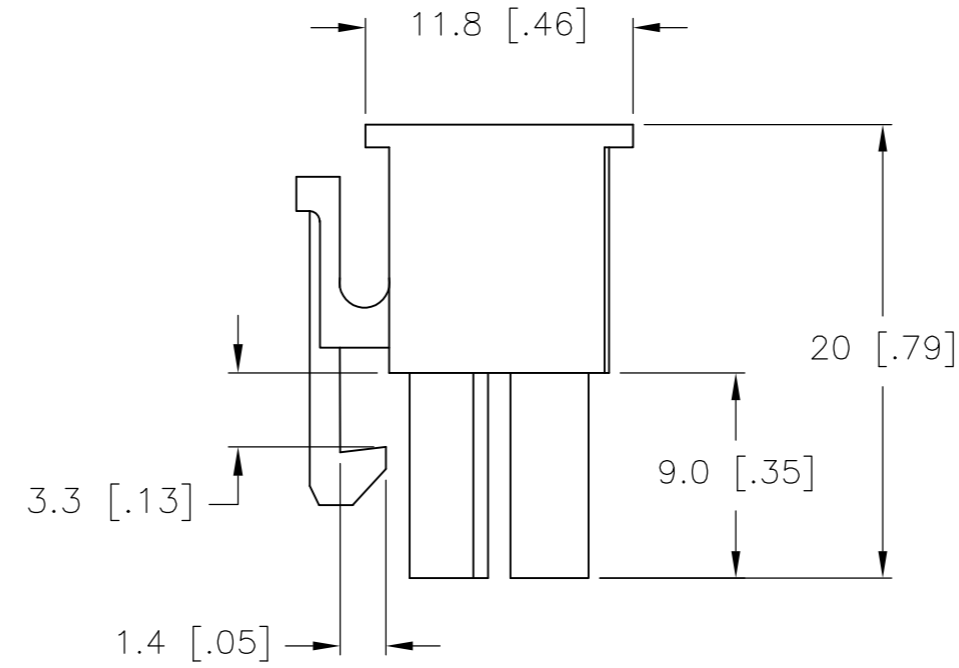
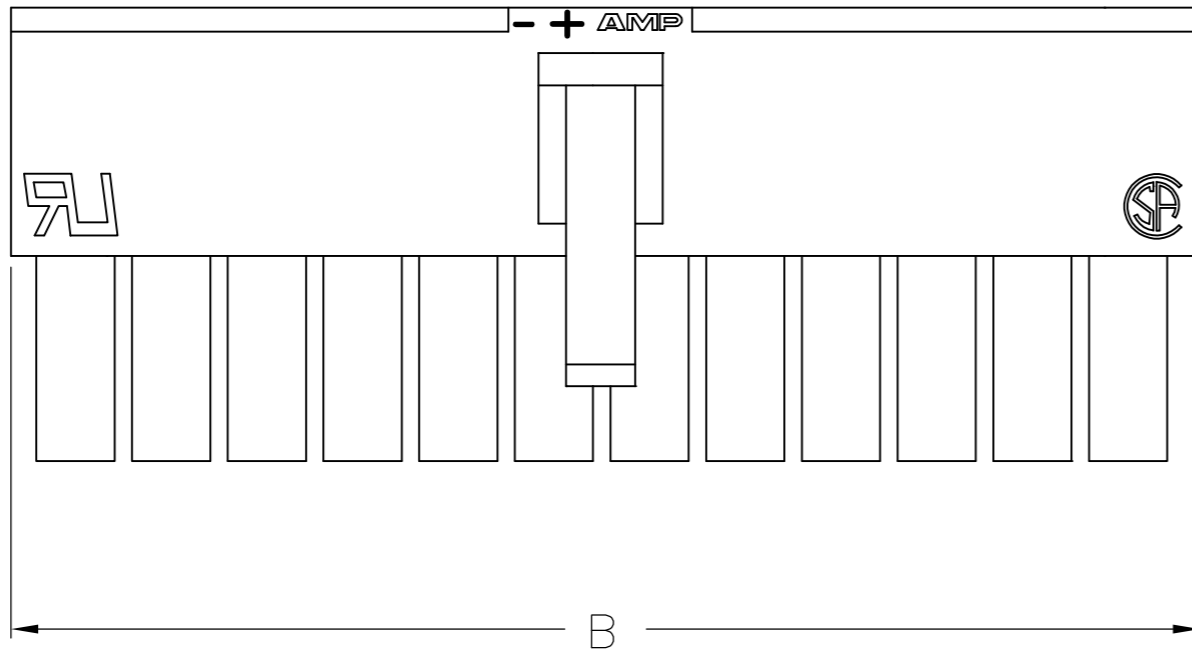

5.4	-	2	1586019-2
9.6	4.2	4	1586019-4
13.8	8.4	6	1586019-6
18.0	12.6	8	1586019-8
22.2	16.8	10	1-1586019-0
26.4	21.0	12	1-1586019-2
30.6	25.2	14	1-1586019-4
34.8	29.4	16	1-1586019-6
39.0	33.6	18	1-1586019-8
43.2	37.8	20	2-1586019-0
47.4	42.0	22	2-1586019-2
51.6	46.2	24	2-1586019-4
DIM B	DIM A	POS.	PART NUMBER

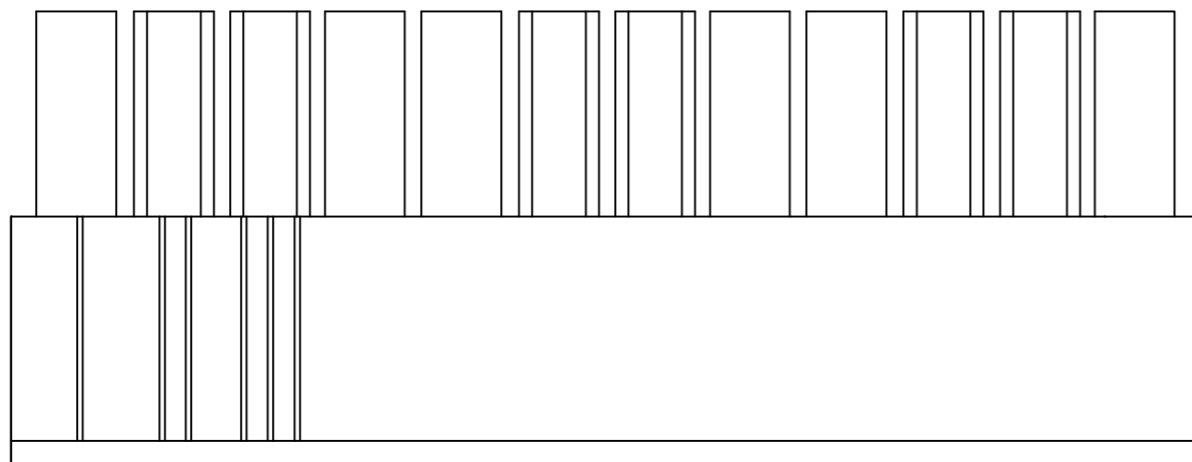

THIS DRAWING IS A CONTROLLED DOCUMENT.

DIMENSIONS: mm [INCHES]	TOLERANCES UNLESS OTHERWISE SPECIFIED: 0 PLC ± 1 PLC ± 0.4 [.02] 2 PLC ± 0.25 [.010] 3 PLC ± 0.150 [.0059] 4 PLC ± ANGLES ± FINISH	DWN S. HOOVER 19-AUG-2002 CHK D. COLEY 19-AUG-2002 APVD D. COLEY 19-AUG-2002 PRODUCT SPEC APPLICATION SPEC	NAME RECEPTACLE HOUSING, VO, VAL-U-LOK(TM)
MATERIAL 1	WEIGHT	SIZE A2 CAGE CODE 00779 DRAWING NO. C=1586019	RESTRICTED TO -
CUSTOMER DRAWING		SCALE 3:1	SHEET 1 OF 1 REV C

TE Connectivity