

NUMBER 178288
METRIC
三線3rd ANGLE PROJECTION

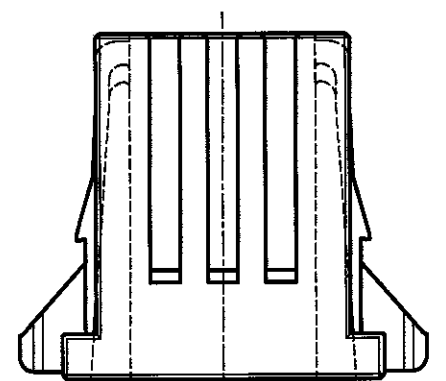
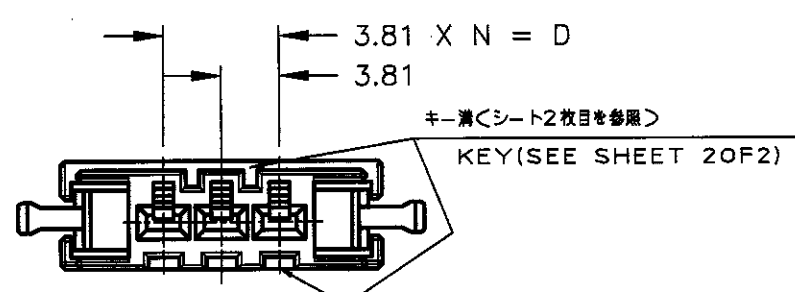
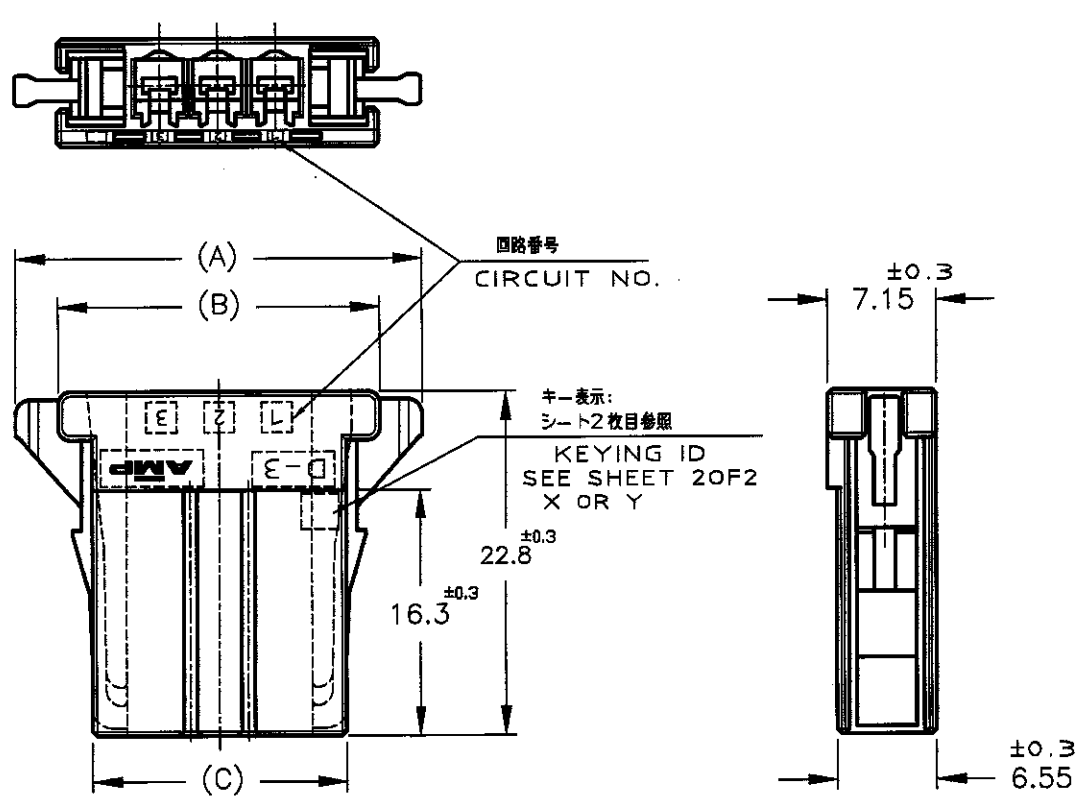

NOTE
1 MATERIAL:GLASS FIELD THERMO PLASTIC,POLYESTER
COLOR;BLACK
△ TO COAT ALL SURFACE OF HOUSING WITH TEFLON

注記
1 材料:ガラス入り熱可塑性ポリエステル樹脂
色;黒色
△ ハウジング全面にテフロン塗装のこと

FINISH	POS.	DIMENSION	A	B	C	D	N	PART NUMBER
	10 POS.		53.43	47.83	43.37	34.29	9	2-178288-8
	10 POS.		53.43	47.83	43.37	34.29	9	1-178288-8
	8 POS.		45.81	40.12	35.97	26.67	7	1-178288-7
	6 POS.		38.19	32.59	28.13	19.05	5	2-178288-6
	6 POS.		38.19	32.59	28.13	19.05	5	1-178288-6
	5 POS.		34.38	28.78	24.32	15.24	4	1-178288-5
	4 POS.		30.57	24.97	20.51	11.43	3	2-178288-4
	4 POS.		30.57	24.97	20.51	11.43	3	1-178288-4
△	3 POS.		26.76	21.16	16.7	7.62	2	6-178288-3
△	3 POS.		26.76	21.16	16.7	7.62	2	5-178288-3
	3 POS.		26.76	21.16	16.7	7.62	2	2-178288-3
	3 POS.		26.76	21.16	16.7	7.62	2	1-178288-3

E2 ADD P/N. (FJ00-1259-00) D.M. S.M. 11/89				Copyright ©1991 * Tyco Electronics AMP K.K. ALL RIGHTS RESERVED.		AMP Tyco Electronics AMP K.K. Kawasaki, Japan	
E1	REVISED (FJ00-2710-95)	NM	Y.I.	6-13 '95	線径範囲(WIRE RANGE)	絶縁外径(INSULATION DIA.)	名称(NAME)
E	REVISED (FJ00-1468-94)	KI	S.M.	1-10 '95	mm² (AWG -)	mmφ	REC HSG FOR DYNAMIC, SINGLE ROW ダイナミックD-3100リセハウジング
D	REVISED (J-1389)	YT	S.M.	6-11 '92	材料(MATERIAL)	仕上(FINISH)	一般公差(GENERAL TOLERANCE)
C	REVISED (J-1184)	NM	H.O.	3-4 '92	SEE NOTE 注記参照		100% 300% 300% 100% ±0.2 ±0.25 ±0.3 ±3
B	REDRAWN (J-0327)	NM	H.O.	8-26 '91	DR. 9 JUL 91 N. Matsubara	DE. 9 JUL 91 N. Matsubara	SIZE B J
LTR	変更 (REVISION RECORD)	DR	CHK	DATE	CHK. 17 JUL 91 T. Obata	APP. 17-DEC-'91 S. MANABE	REV. E2 SHEET 1 OF 2

PRINT DIST
DIMENSIONS IN MM. DO NOT SCALE PRINT

NUMBER 178288



METRIC

KEYING LOCATION

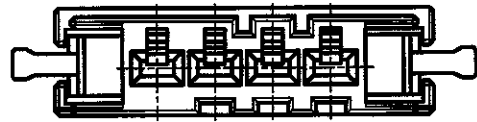

(P/N 2-178288-4 ONLY)
(KEYING: Y)

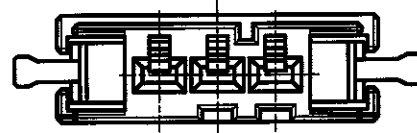

6-178288-3
(P/N 2-178288-3 ONLY)
(KEYING: Y)

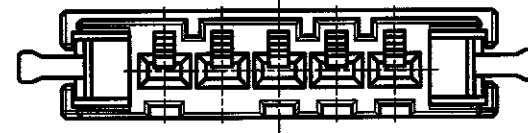

(P/N 2-178288-6,-8)
(KEYING: Y)

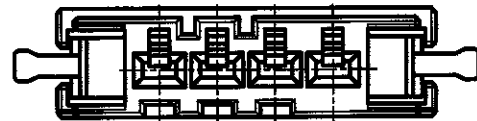

(P/N 1-178288-4 ONLY)
(KEYING: X)

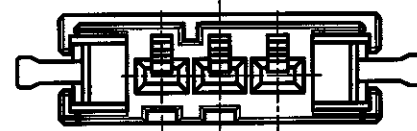

5-178288-3
(P/N 1-178288-3 ONLY)
(KEYING: X)

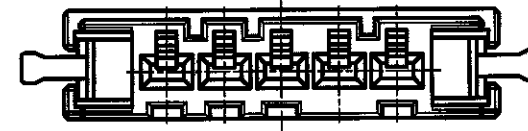

(P/N 1-178288-5,-6,-7,-8)
(KEYING: X)

図: 寸法 DIMENSIONS IN MM. DO NOT SCALE PRINT

PRINT DIST

				Copyright ©1991 * サイコ・エレクトロニクス・ジャパン株式会社		Copyright ©1991 Tyco Electronics AMP K.K. ALL RIGHTS RESERVED.		AMP Tyco Electronics AMP K.K. Kawasaki, Japan	
				適合電線径範囲(WIRE RANGE) mm ² KAWG - >		絶縁径(INSULATION DIA.) mmφ		名称(NAME) REC HSG FOR DYNAMIC, SINGLE ROW ダイナミックD-3100リセハウジング	
				材質(MATERIAL) SEE NOTE 注記参照		仕上(FINISH)		一般公差 (GENERAL TOLERANCE) 10mm ±0.2 10mm以下 ±0.25 30mm以下 ±0.3 角 度 ±3°	
SEE 1 OF 2				DR.		DE. OF 2		SIZE LOC 番号(No.) B J 178288	
LTR 変更 (REVISION RECORD)				DR		CHK DATE		尺数(SCALE) REV. SHEET 2-1 E2 2 OF 2	
				CHK.		APP.			