

NUMBER 178288
METRIC
三線3rd ANGLE PROJECTION

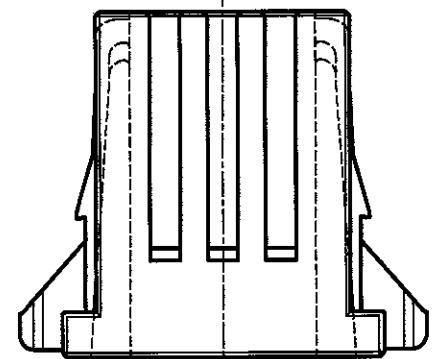
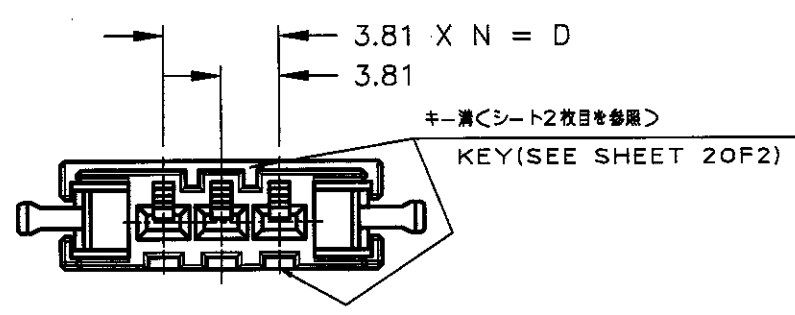
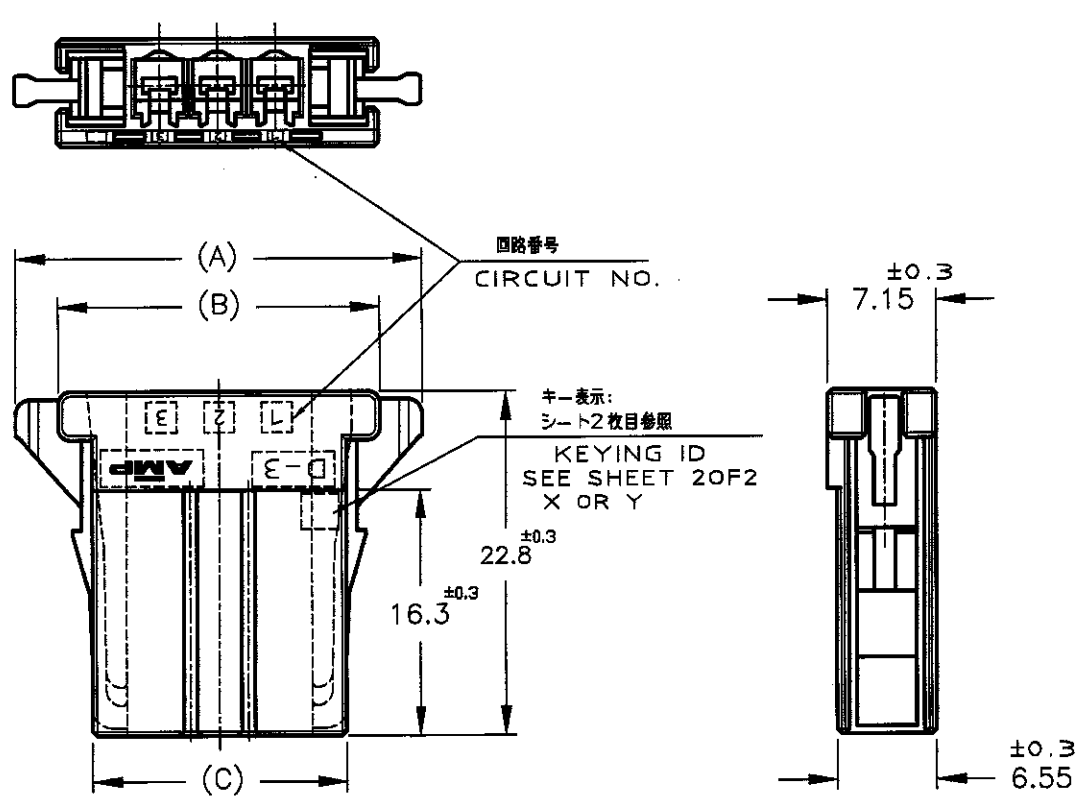

NOTE
1 MATERIAL: GLASS FIBER THERMO PLASTIC, POLYESTER
COLOR: BLACK
△ TO COAT ALL SURFACE OF HOUSING WITH TEFLON

注記
1 材料: ガラス入り熱可塑性ポリエステル樹脂
色: 黒色
△ ハウジング全面にテフロン塗装のこと

FINISH	POS.	DIMENSION	A	B	C	D	N	PART NUMBER
	10 POS.		53.43	47.83	43.37	34.29	9	2-178288-8
	10 POS.		53.43	47.83	43.37	34.29	9	1-178288-8
	8 POS.		45.81	40.12	35.97	26.67	7	1-178288-7
	6 POS.		38.19	32.59	28.13	19.05	5	2-178288-6
	6 POS.		38.19	32.59	28.13	19.05	5	1-178288-6
	5 POS.		34.38	28.78	24.32	15.24	4	1-178288-5
	4 POS.		30.57	24.97	20.51	11.43	3	2-178288-4
	4 POS.		30.57	24.97	20.51	11.43	3	1-178288-4
△	3 POS.		26.76	21.16	16.7	7.62	2	6-178288-3
△	3 POS.		26.76	21.16	16.7	7.62	2	5-178288-3
	3 POS.		26.76	21.16	16.7	7.62	2	2-178288-3
	3 POS.		26.76	21.16	16.7	7.62	2	1-178288-3

PRINT DIST
DIMENSIONS IN MM. DO NOT SCALE PRINT

E2 ADD P/N. (FJ00-1259-00) D.M. S.M. 11/89				Copyright ©1991 * Tyco Electronics AMP K.K. ALL RIGHTS RESERVED.		AMP Tyco Electronics AMP K.K. Kawasaki, Japan	
E1 REVISED (FJ00-2710-95) NM Y.I. 6-13 '95	WIRE RANGE (mm² (AWG -))		INSULATION DIA. (mmφ)		REC HSG FOR DYNAMIC, SINGLE ROW ダイナミックD-3100リセハウジング		
E REVISED (FJ00-1468-94) KI S.M. 1-10 '95	MATERIAL (SEE NOTE)		FINISH		GENERAL TOLERANCE		
D REVISED (J-1389) YT S.M. 6-11 '92	DR. 9 JUL 91 N. Matsubara		DE. 9 JUL 91 N. Matsubara		SIZE B J	LOC J	REV. 178288
C REVISED (J-1184) NM H.O. S.M. 3-4 '92	CHK. 17 JUL 91 T. Obata		APP. 17-DEC-'91 S. MANABE		SCALE 2-1	REV. E2	SHEET 1 OF 2
B REDRAWN (J-0327) NM H.O. S.M. 8-26 '91	LTR 変更 (REVISION RECORD) DR CHK DATE						

NUMBER 178288

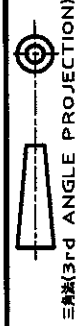

METRIC

PRINT DIST
註: 寸法はmm単位で表示する。寸法はmm単位で表示する。DO NOT SCALE PRINT

KEYING LOCATION

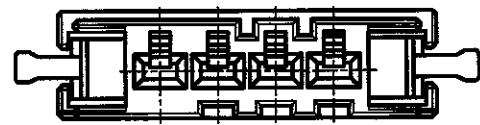

(P/N 2-178288-4 ONLY)
(KEYING: Y)

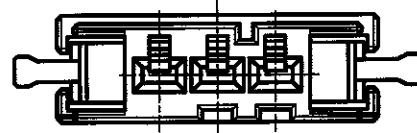

6-178288-3
(P/N 2-178288-3 ONLY)
(KEYING: Y)

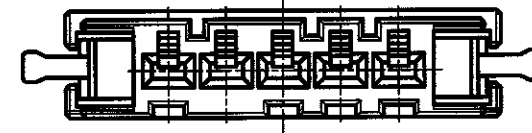

(P/N 2-178288-6,-8)
(KEYING: Y)

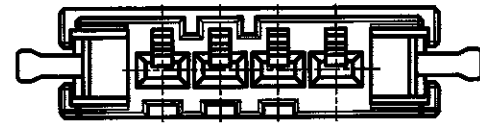

(P/N 1-178288-4 ONLY)
(KEYING: X)

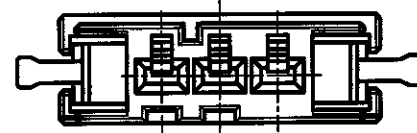

5-178288-3
(P/N 1-178288-3 ONLY)
(KEYING: X)

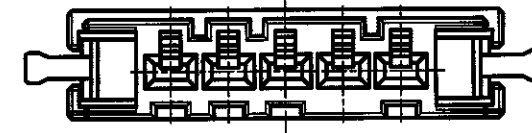

(P/N 1-178288-5,-6,-7,-8)
(KEYING: X)

				Copyright ©1991 * サイコ・エレクトロニクス・ジャパン株式会社		Copyright ©1991 Tyco Electronics AMP K.K. ALL RIGHTS RESERVED.		AMP Tyco Electronics AMP K.K. Kawasaki, Japan	
				適合電線径範囲(WIRE RANGE) mm ² KAWG - >		絶縁径(INSULATION DIA.) mmφ		名称(NAME) REC HSG FOR DYNAMIC, SINGLE ROW ダイナミックD-3100リセハウジング	
				材質(MATERIAL) SEE NOTE 注記参照		仕上(FINISH)		一般公差 (GENERAL TOLERANCE) 10mm ±0.2 10mm以下 ±0.25 30mm以下 ±0.3 角 度 ±3°	
SEE 1 OF 2				DR.		DE. OF 2		SIZE LOC 番号(No.) B J 178288	
LTR 変更 (REVISION RECORD)				DR		CHK DATE		尺数(SCALE) REV. SHEET 2-1 E2 2 OF 2	

PRINT DIST