

THIS DRAWING IS UNPUBLISHED. RELEASED FOR PUBLICATION 2006  
 © COPYRIGHT 2006 ALL RIGHTS RESERVED.

LOC		DIST		REVISIONS			DATE	DWN	APVD
P	LTR	DESCRIPTION							
J		D	REVISED			14JUN2013	H.U	N.Y	

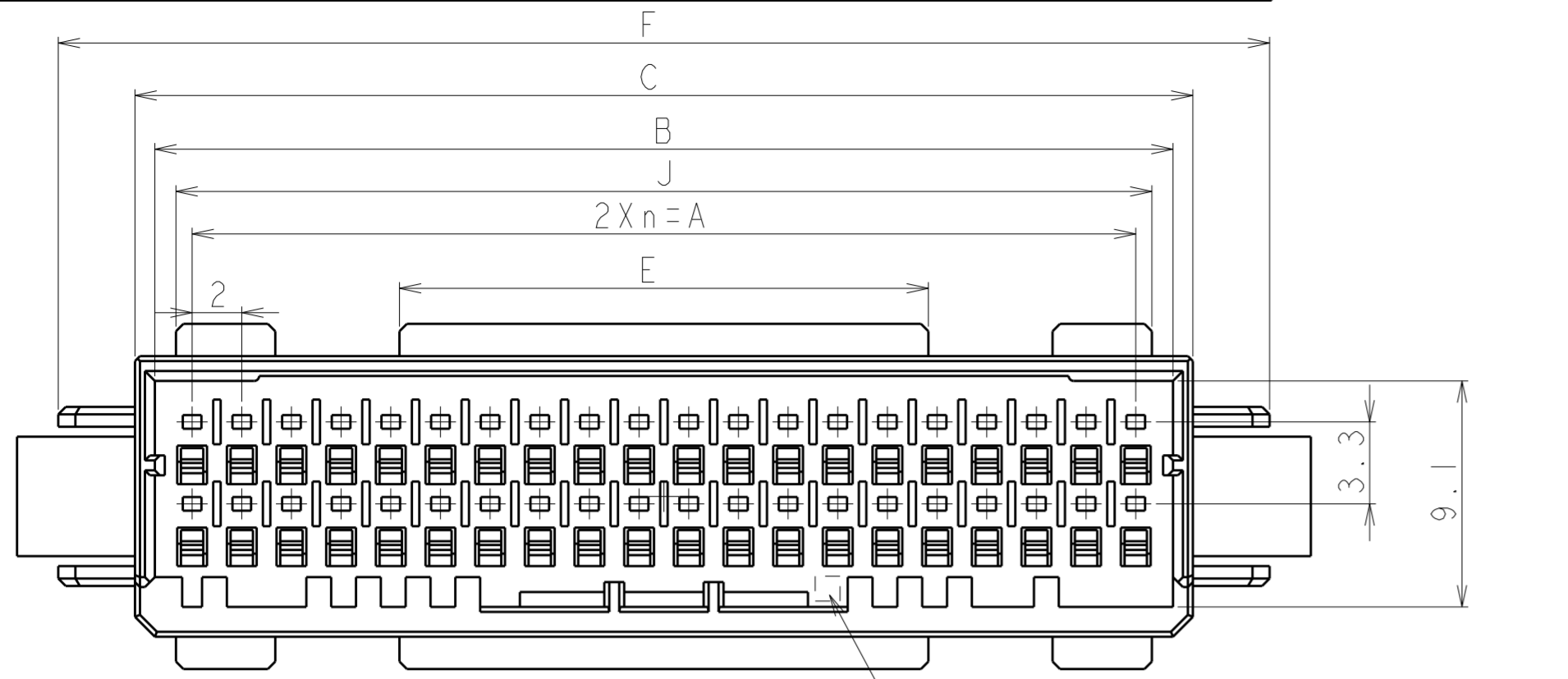

CAVITY MARK  
(ALPHABET: CAPITAL LETTER)

40POS(X-KEY): 1-1903128-0

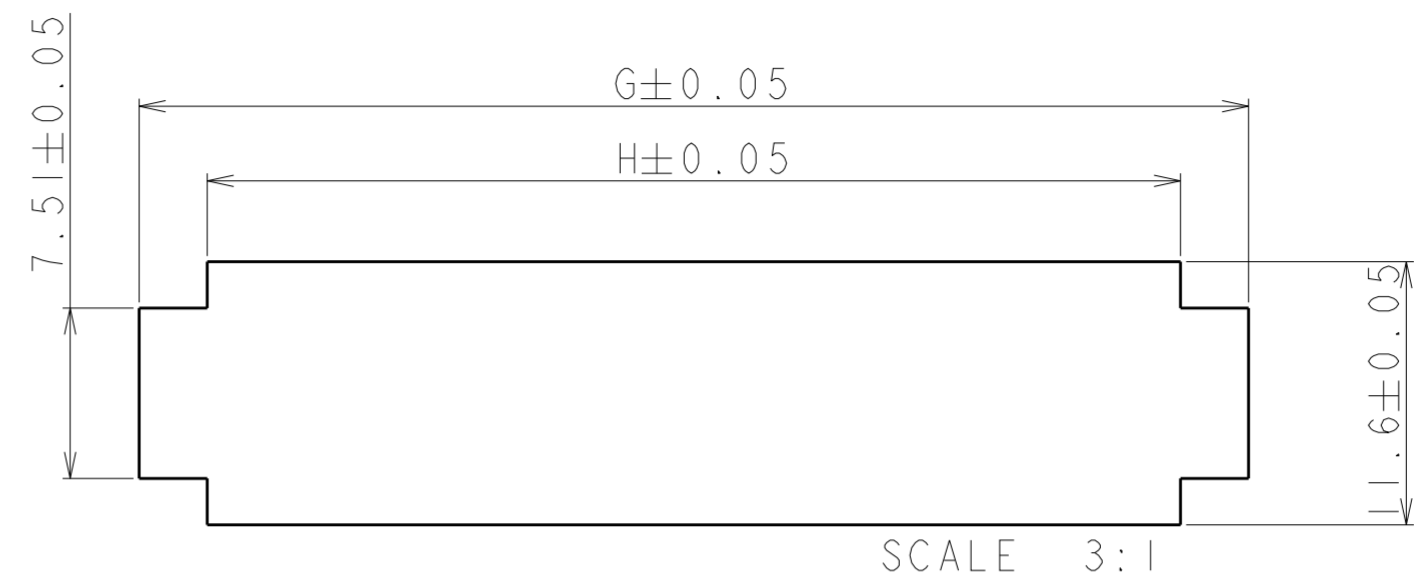

RECOMMENDED PANEL LAYOUT  
(APPLICABLE PANEL THICKNESS : 0.8, 1.0, 1.6, 2.0)

パネル加工推奨寸法図  
(適用パネル厚 : 0.8, 1.0, 1.6, 2.0)

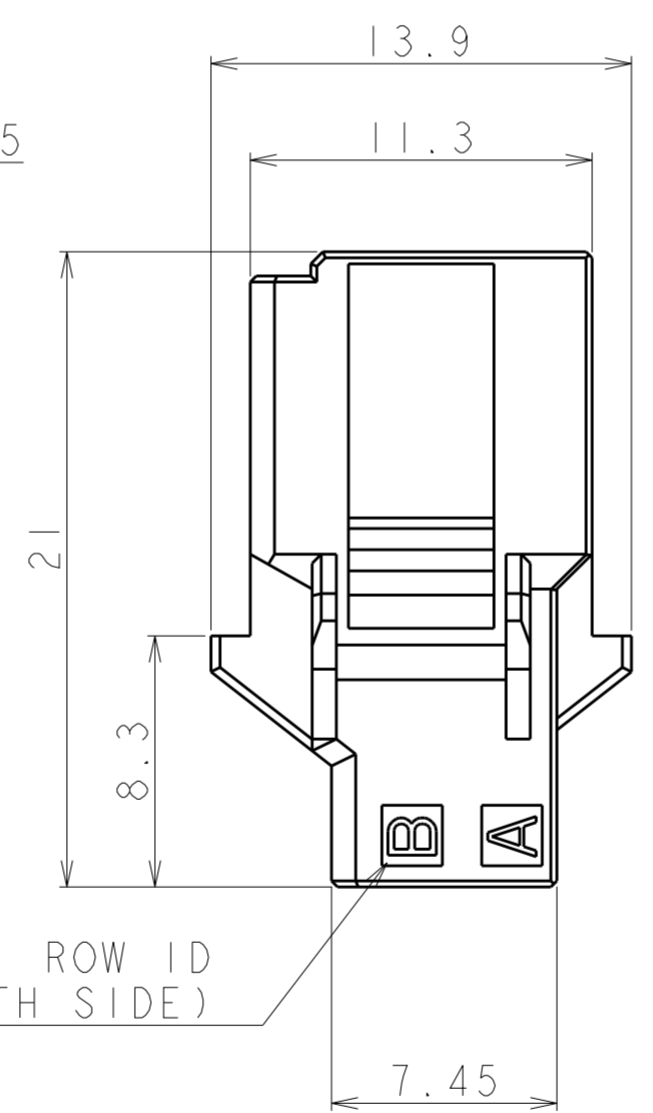
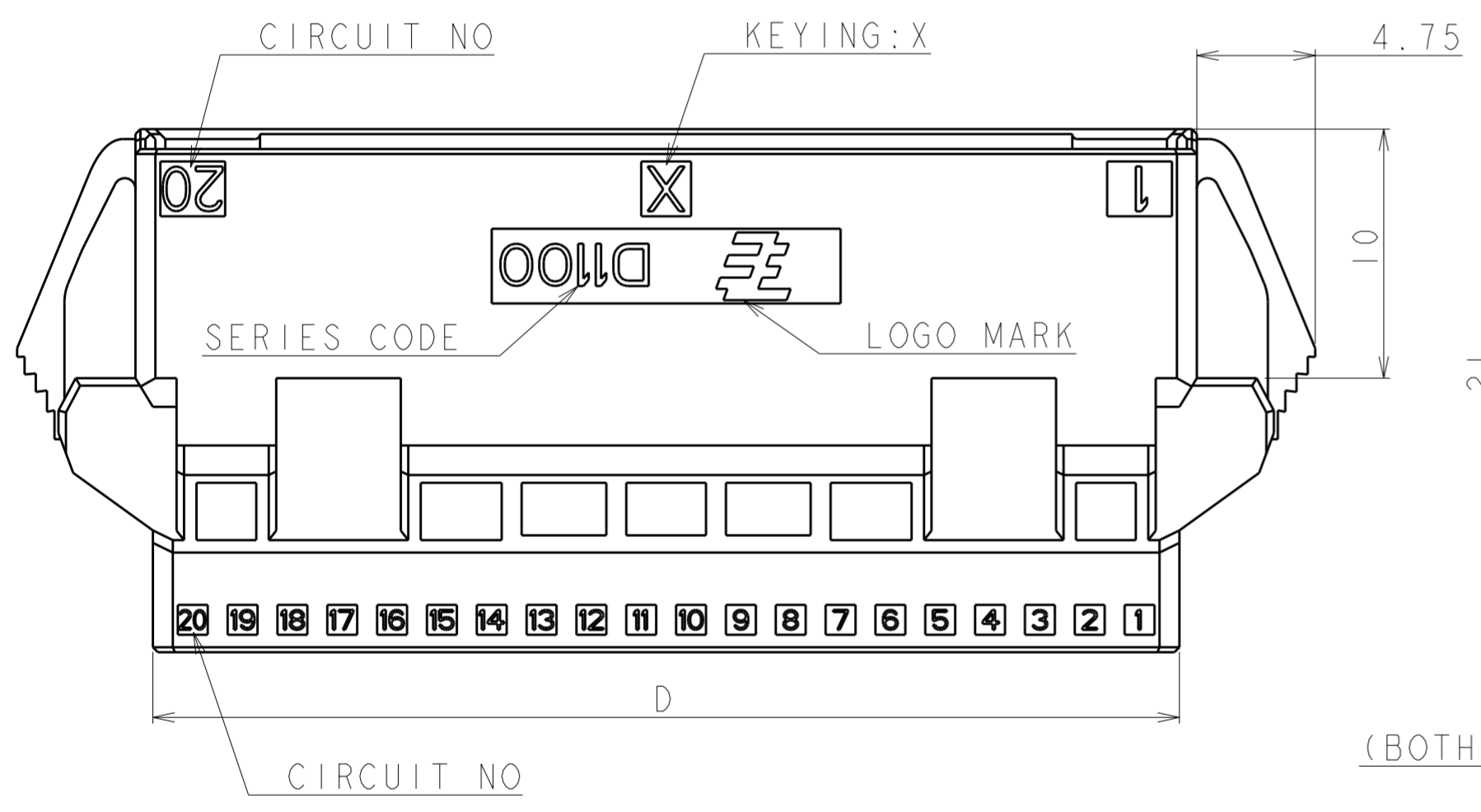

1. MATERIAL: GLASS FILLED THERMO PLASTIC POLYESTER(94V-0), COLOR: BLACK  
 2. THE SHAPE, SIZE AND POSITION OF THE CHARACTER SHOW THE OUTLINE. THEY DON'T SHOW DETAILS.

1. 材料: ガラス入り熱可塑性ポリエステル樹脂(94V-0), 色: 黒  
 2. 文字の形状、大きさ、および位置については、大略を示すものであり、詳細を示すものではありません。

AS SHOWN 40POS : 1-1903128-0

40	X	19	38.0	41.0	42.6	41.2	21.3	48.7	48.9	42.9	39.3	1-1903128-0
34	X	16	32.0	35.0	36.6	35.2	18.3	42.7	42.9	36.9	33.3	1-1903128-7
32	X	15	30.0	33.0	34.6	33.2	17.3	40.7	40.9	34.9	31.3	1-1903128-6
28	X	13	26.0	29.0	30.6	29.2	15.3	36.7	36.9	30.9	27.3	1-1903128-4
26	X	12	24.0	27.0	28.6	27.2	14.3	34.7	34.9	28.9	25.3	1-1903128-3
22	X	10	20.0	23.0	24.6	23.2	12.3	30.7	30.9	24.9	21.3	1-1903128-1
POS	KEY	n	A	B	C	D	E	F	G	H	J	PART NO

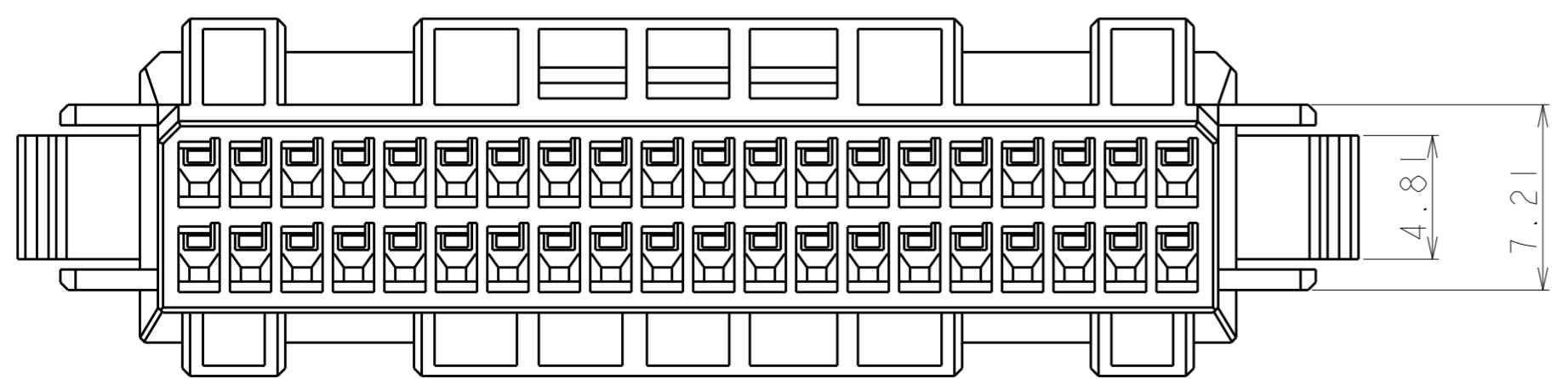

THIS DRAWING IS A CONTROLLED DOCUMENT.

DIMENSIONS: 単位: 概 mm

TOLERANCES UNLESS OTHERWISE SPECIFIED: 一般公差 ±0.3, ±3°

MATERIAL 材料

FINISH 仕上

DWN: M. MAEBASHI 17APR2006  
 CHK: T. KUDO 17APR2006  
 APVD: D. MITSUGI 17APR2006

PRODUCT SPEC: 108-78268, 78298  
 APPLICATION SPEC: 114-5377

NAME: DYNAMIC D1100D 2.0mm PITCH TAB HSG, PANEL MOUNT TYPE 22-40 POS

SIZE: A2 CAGE CODE: 00779 DRAWING NO: C-1903128

RESTRICTED TO: 4:1 SHEET 1 OF 3 REV D

CUSTOMER DRAWING

THIS DRAWING IS UNPUBLISHED. RELEASED FOR PUBLICATION 2006  
 © COPYRIGHT 2006 ALL RIGHTS RESERVED.

LOC		DIST		REVISIONS			DATE	DWN	APVD
P	LTR	DESCRIPTION							
J		SEE SHEET 1							

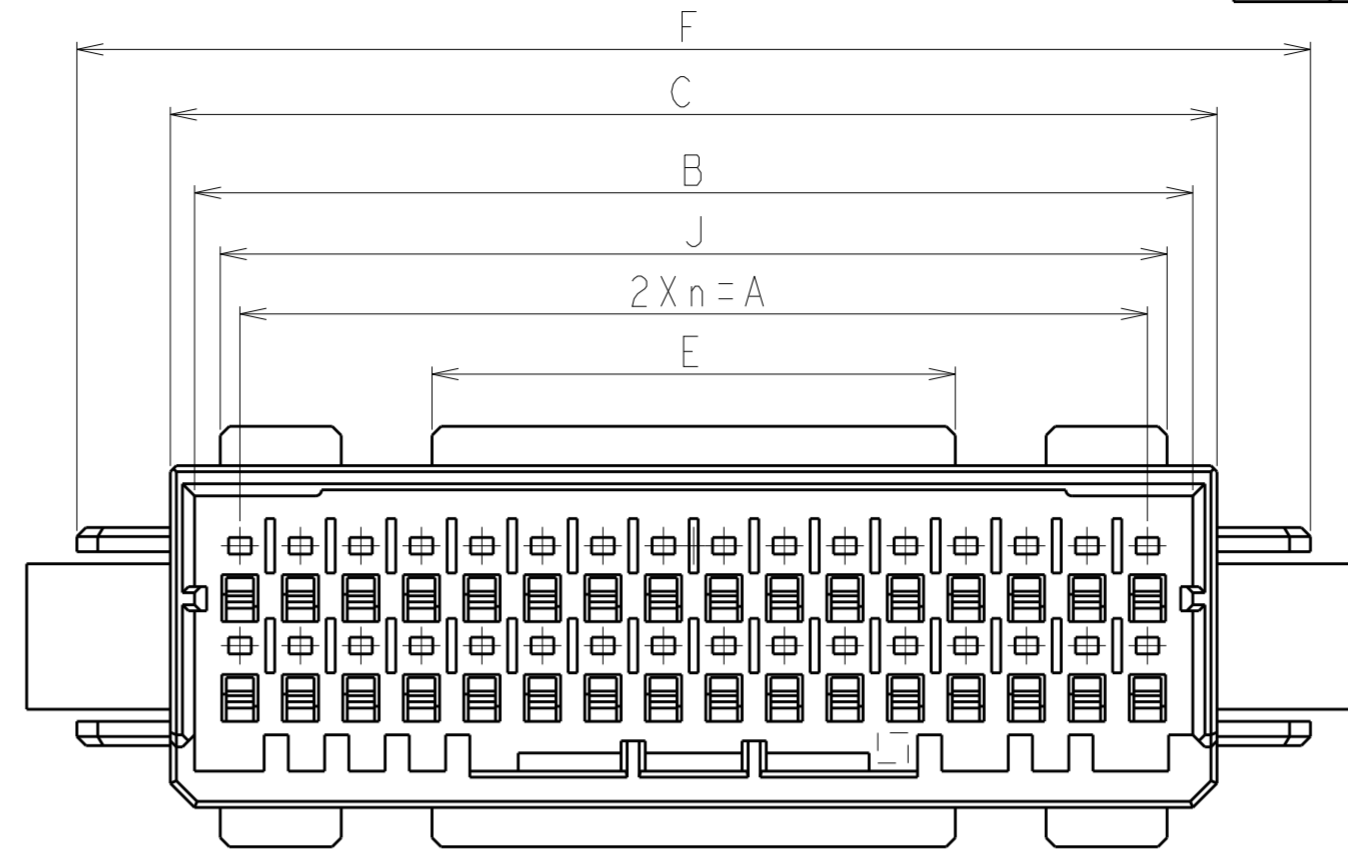
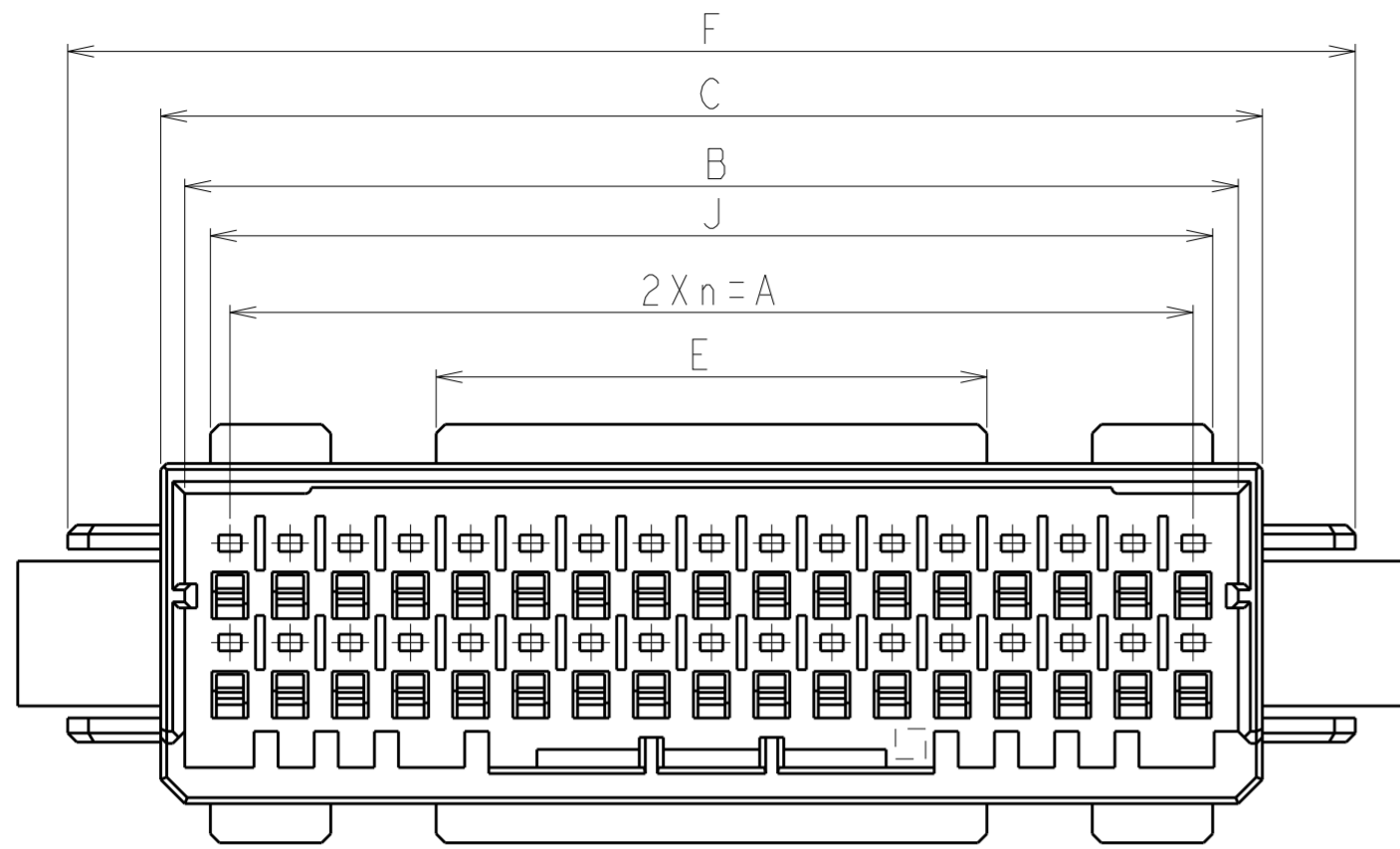

34POS(X-KEY): 1-1903128-7

32POS(X-KEY): 1-1903128-6

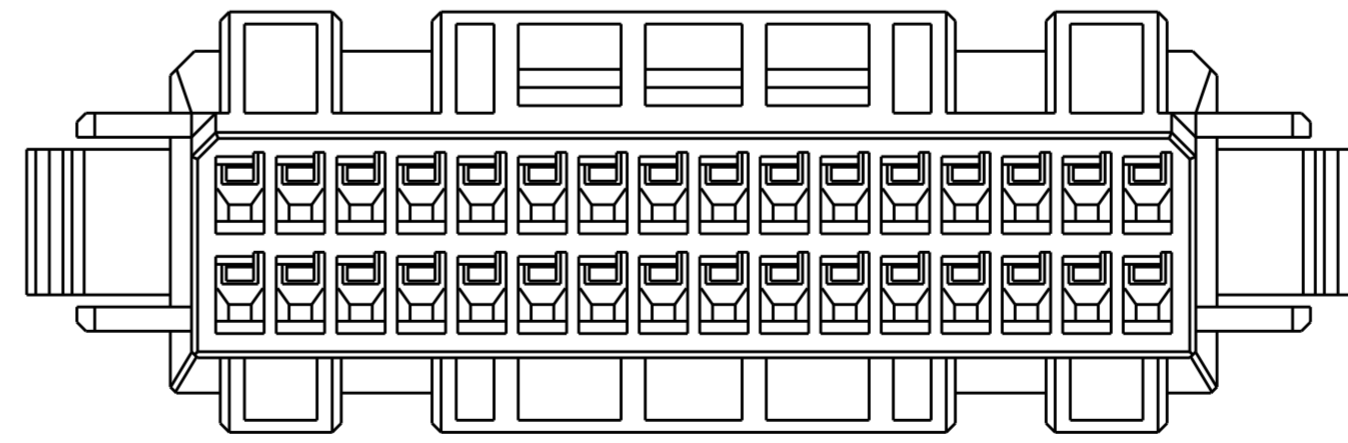
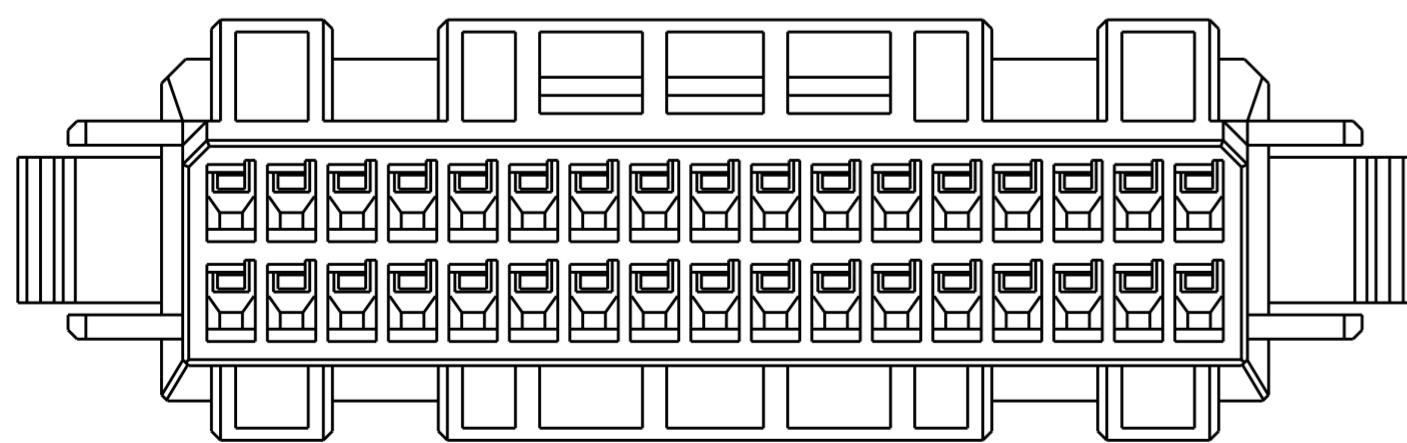
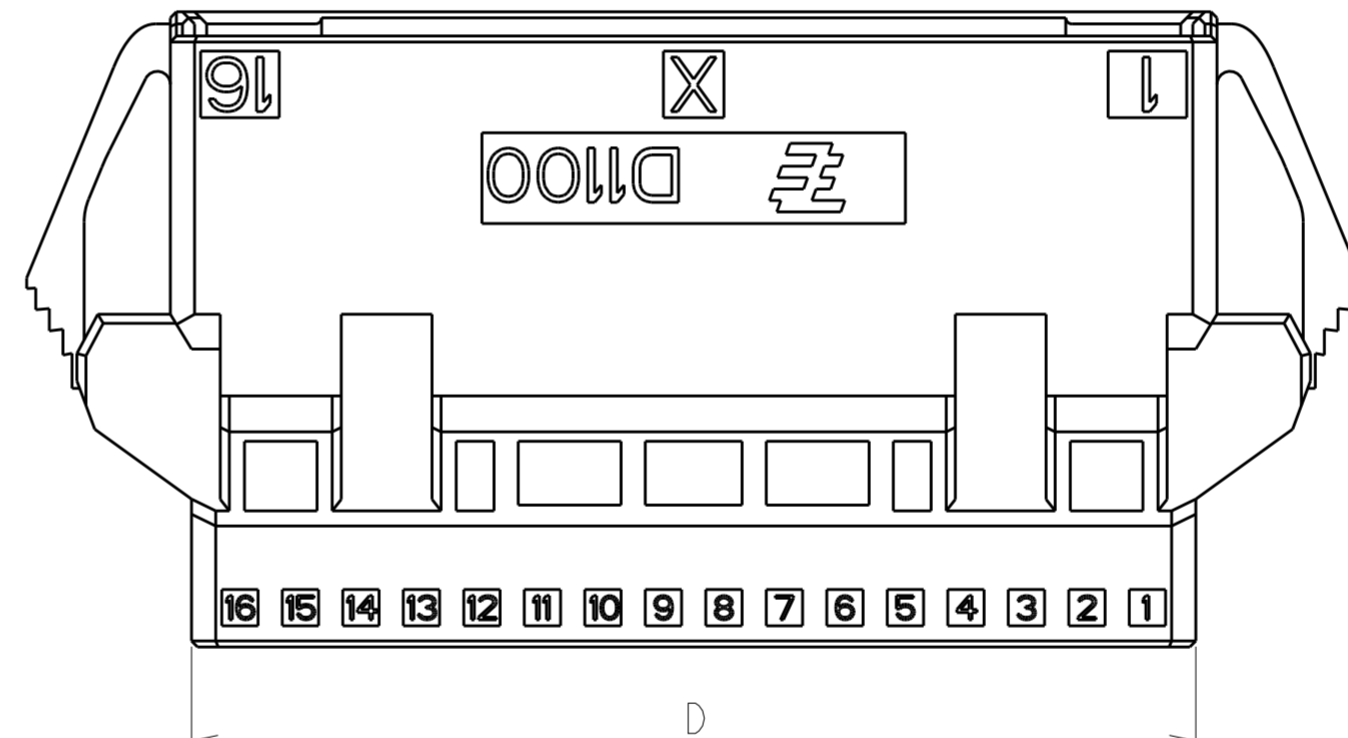
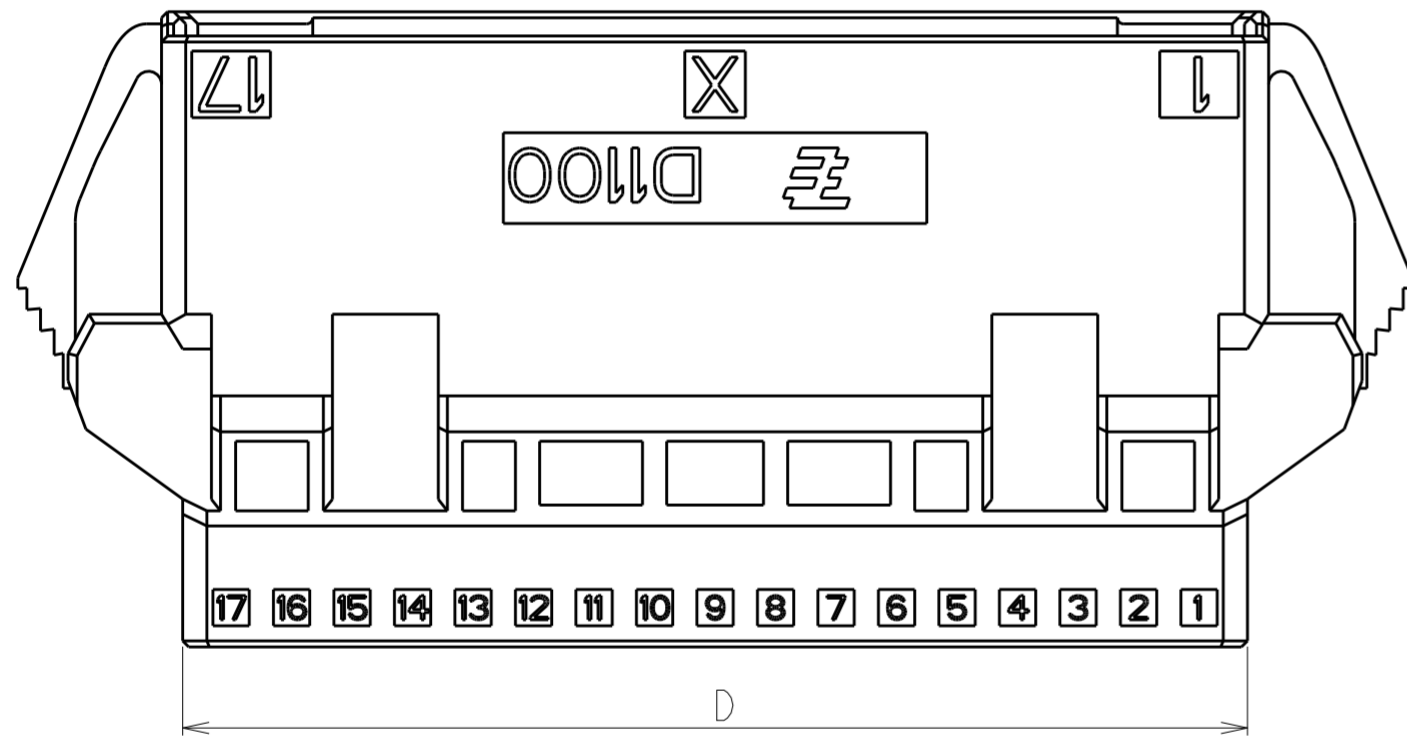

THIS DRAWING IS A CONTROLLED DOCUMENT.		DWN M. MAEBASHI 17APR2006	 TE Connectivity	NAME		
DIMENSIONS: 単位: 寸 mm		CHK T. KUDO 17APR2006		DYNAMIC D1100D 2.0mm PITCH TAB HSG, PANEL MOUNT TYPE 22-40 POS		
TOLERANCES UNLESS OTHERWISE SPECIFIED:		APVD D. MITSUGI 17APR2006		SIZE	CAGE CODE	DRAWING NO
一般公差 0 PLC ± 1 PLC ± 2 PLC ± 3 PLC ± 4 PLC ± ANGLES ± FINISH 仕上		PRODUCT SPEC 108-78268, 78298		A200779	G-1903128	RESTRICTED TO
MATERIAL 材料		APPLICATION SPEC 取付適用規格 114-5377	WEIGHT	SCALE 4:1	SHEET 2 OF 3	
CUSTOMER DRAWING			REV D			

THIS DRAWING IS UNPUBLISHED. RELEASED FOR PUBLICATION 2006  
 © COPYRIGHT 2006 ALL RIGHTS RESERVED.

LOC	DIST	REVISONS			DATE	DWN	APVD
J		P	LTR	DESCRIPTION			
		-		SEE SHEET 1			

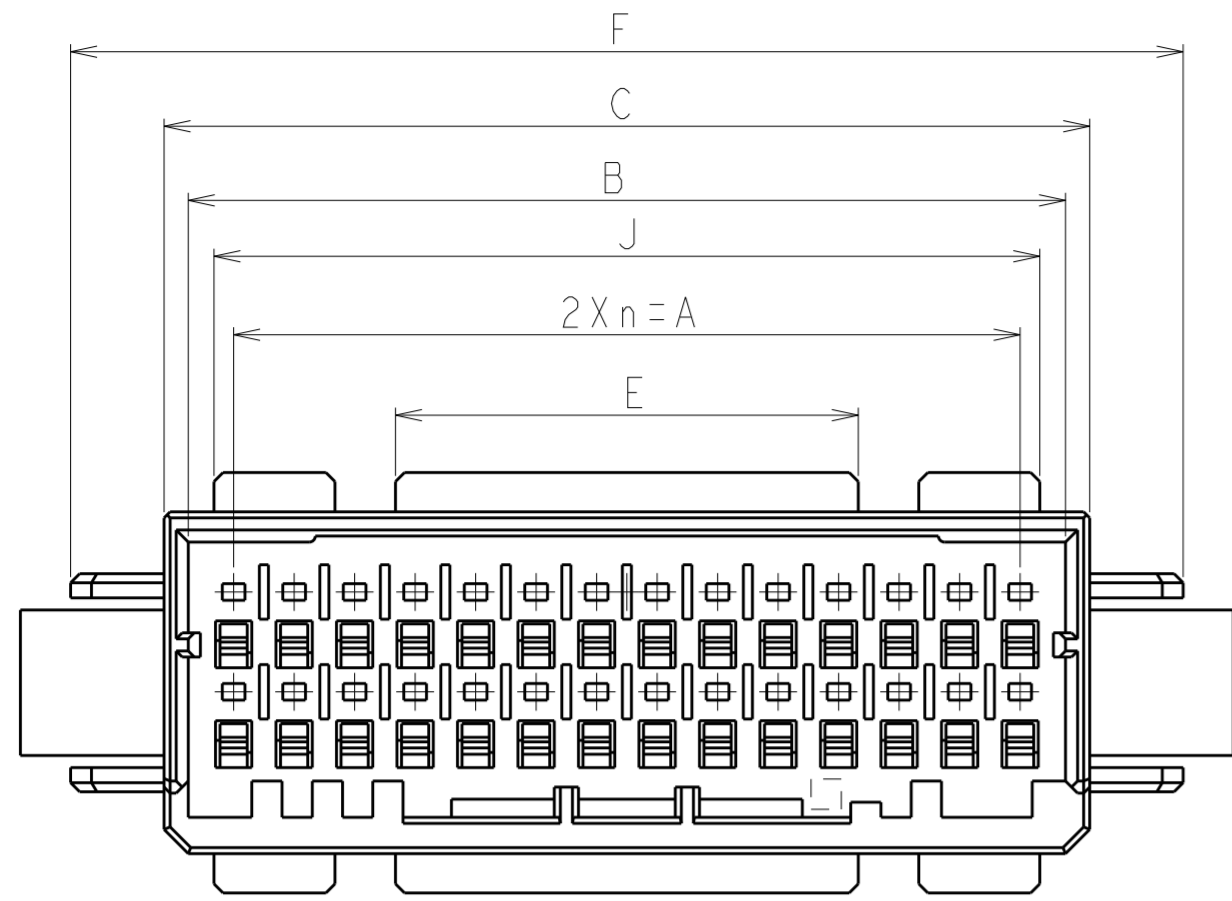

28POS(X-KEY): 1-1903128-4

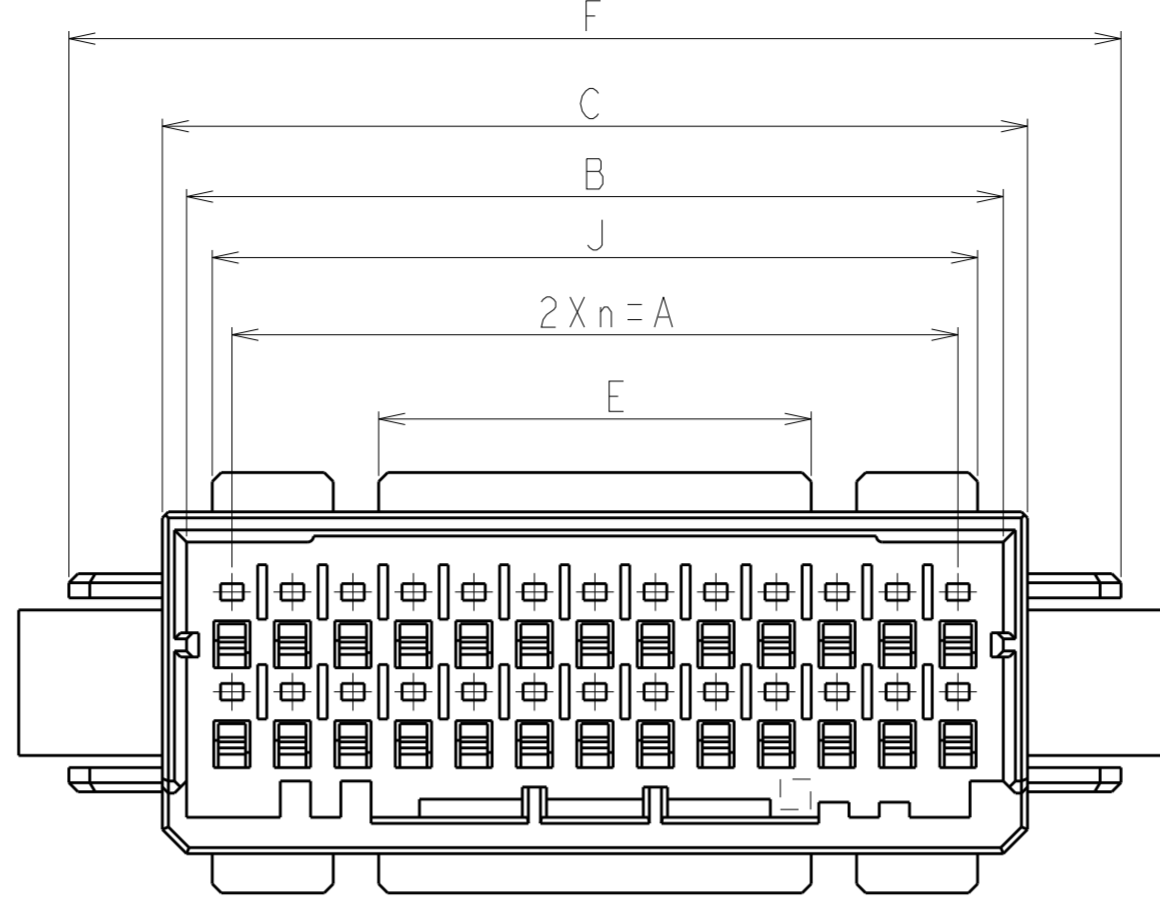

26POS(X-KEY): 1-1903128-3

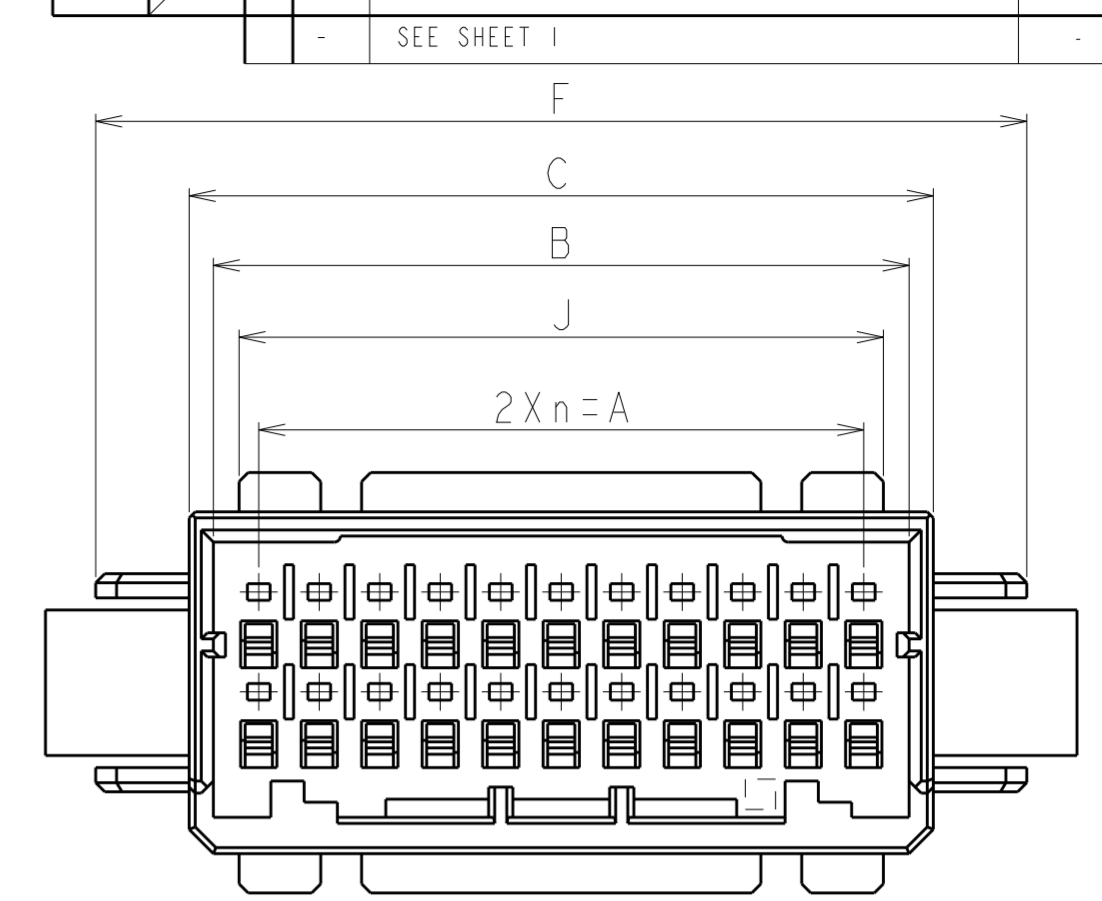

22POS(X-KEY): 1-1903128-1

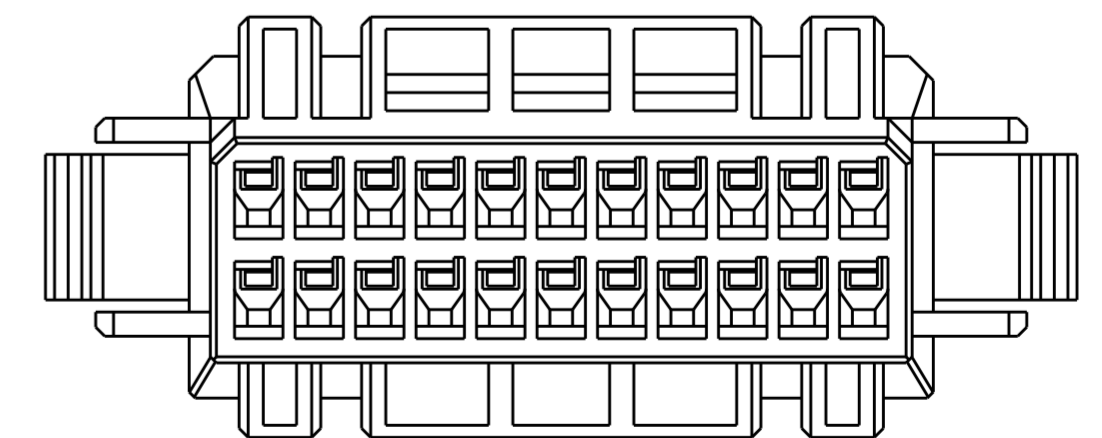
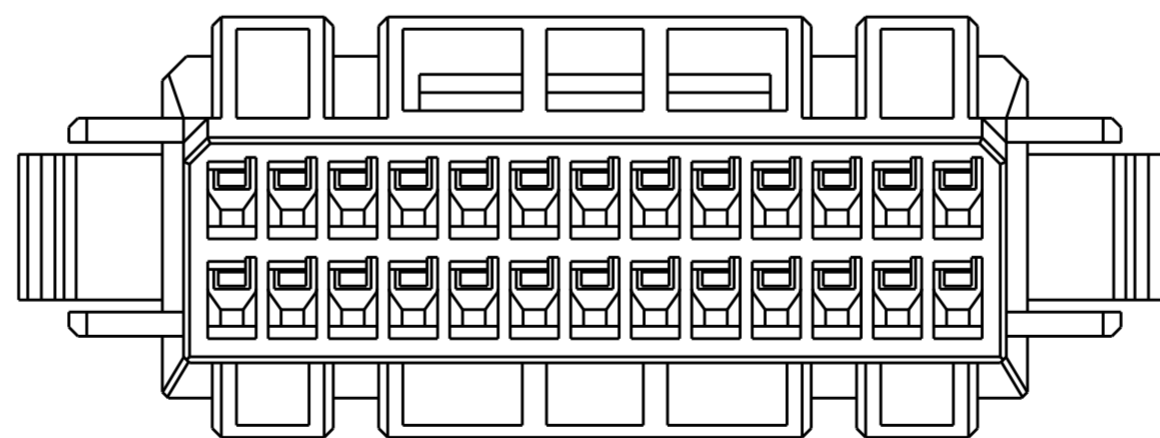
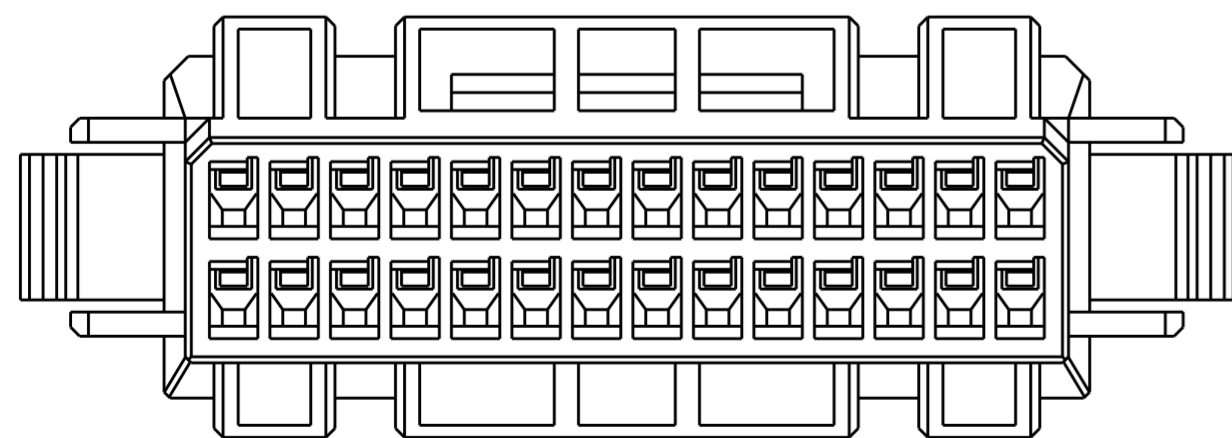
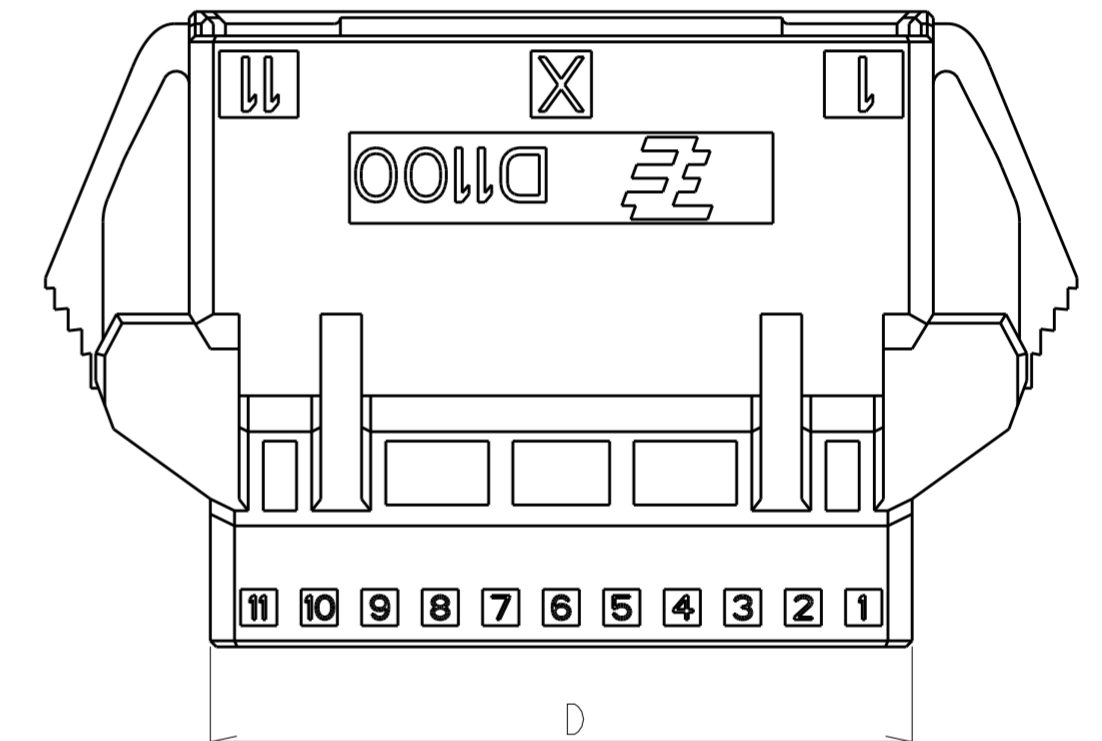
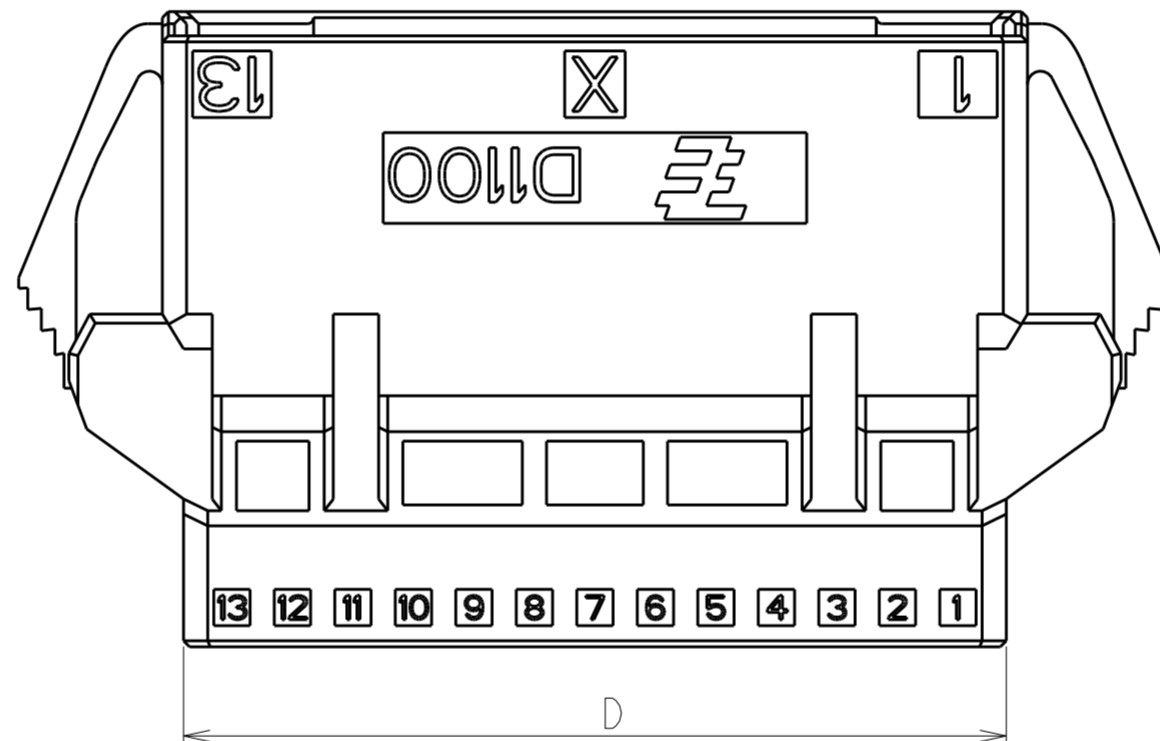
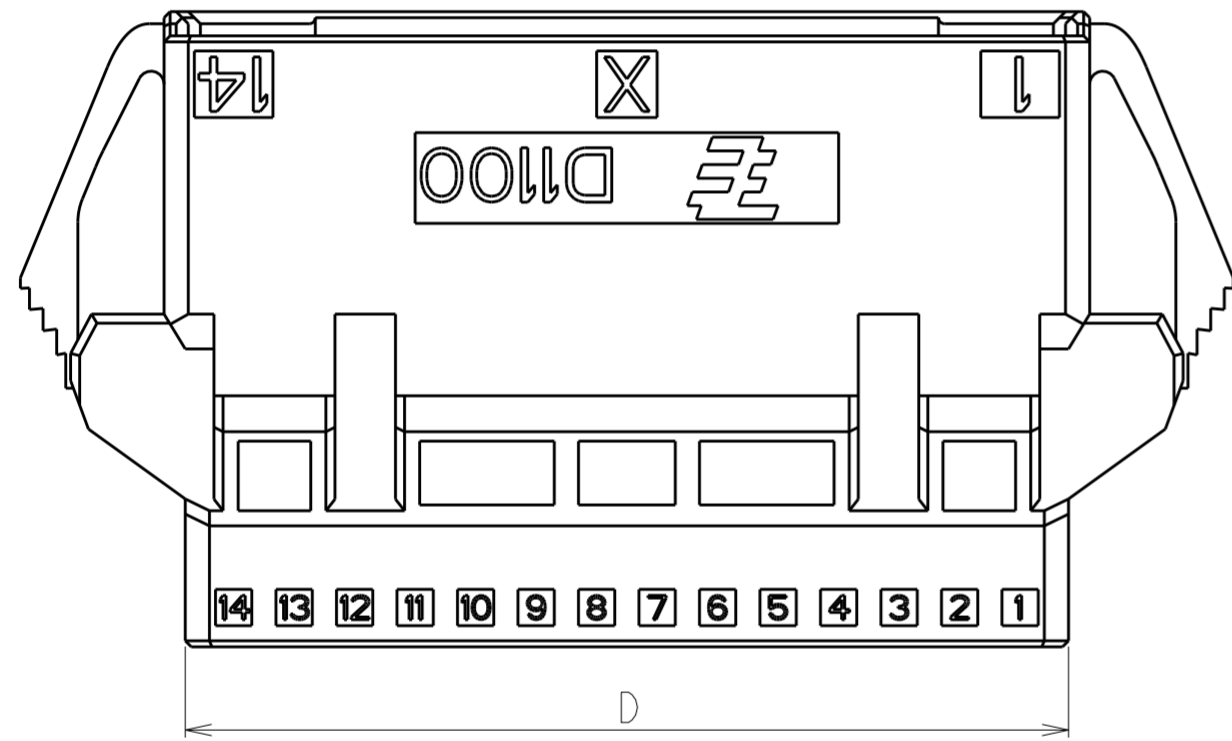

THIS DRAWING IS A CONTROLLED DOCUMENT.		DWN M. MAEBASHI 17APR2006	 TE Connectivity	NAME DYNAMIC D1100D 2.0mm PITCH TAB HSG, PANEL MOUNT TYPE 22-40 POS
DIMENSIONS: 単位: 桁 mm		CHK T. KUDO 17APR2006		
TOLERANCES UNLESS OTHERWISE SPECIFIED:		APVD D. MITSUGI 17APR2006	SIZE A200779	CAGE CODE C-1903128
一般公差 0 PLC ± 1 PLC ± 2 PLC ± 3 PLC ± 4 PLC ± ANGLES ± FINISH 仕上		PRODUCT SPEC 108-78268, 78298 APPLICATION SPEC 114-5377 WEIGHT	DRAWING NO. G-1903128	RESTRICTED TO
MATERIAL 材料		CUSTOMER DRAWING		SCALE 4:1
		SHEET 3 OF 3		REV D