

Distributed by:

JAMECO[®]
ELECTRONICS

www.Jameco.com ♦ 1-800-831-4242

The content and copyrights of the attached
material are the property of its owner.

Jameco Part Number 1961882

THIS DRAWING IS UNPUBLISHED. RELEASED FOR PUBLICATION
 © COPYRIGHT BY TYCO ELECTRONICS CORPORATION. ALL RIGHTS RESERVED.

LOC	DIST	REVISIONS					
FT	0	P	LTR	DESCRIPTION	DATE	DWN	APVD
			C	REVISED PER ECO-06-5529	3/10/06	SS	CR

MATERIAL:
 HOUSING: THERMOPLASTIC POLYESTER, UL94V-0, BLACK
 LEVER: THERMOPLASTIC, UL94V-0, WHITE, UNLESS OTHERWISE NOTED.
 TERMINAL: BRIGHT ACID TIN OVER COPPER ALLOY

ELECTRICAL:
 MAXIMUM CURRENT: 10A
 OPERATING VOLTAGE: 150/300V (LIMITED RATINGS)
 WIRE RANGE: 18-22 AWG

ENVIRONMENTAL:
 MAX OPERATING TEMP: 130°C

△ MARKED WITH WHITE PERMANENT INK.

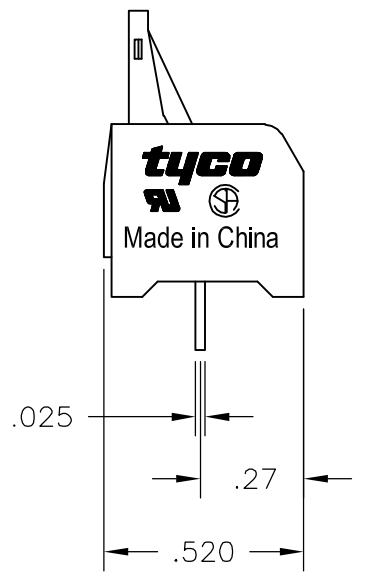
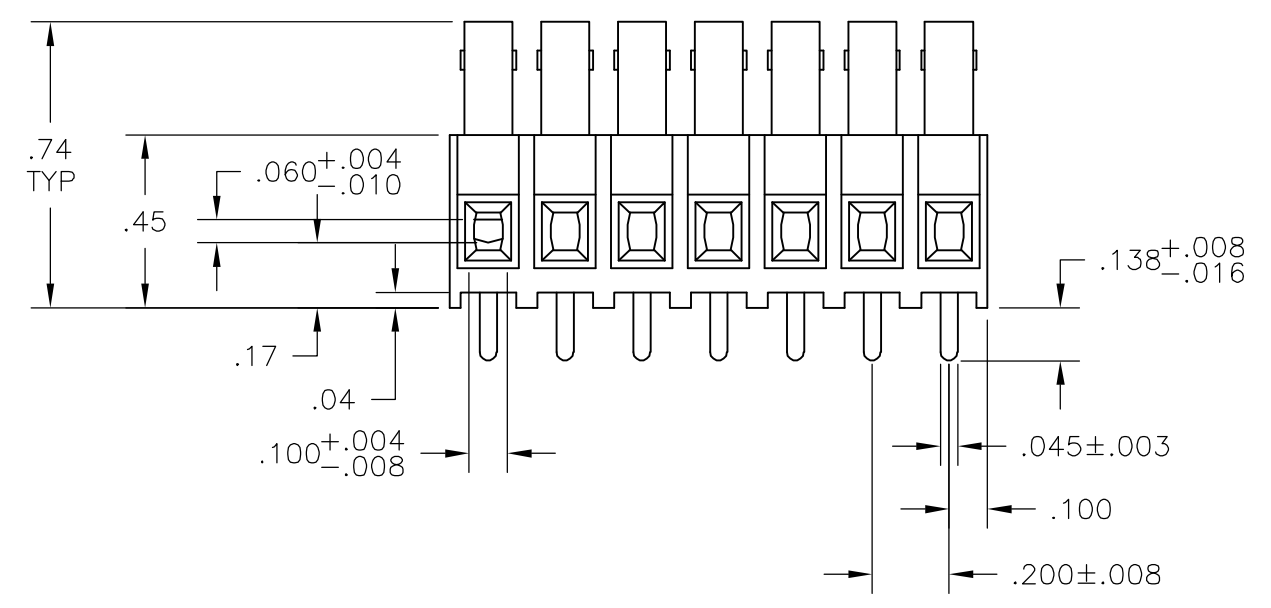
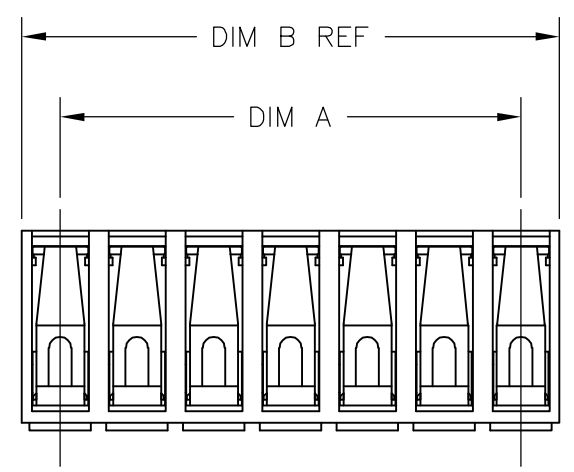

SEE FIGURE 1
 SEE FIGURE 1

SEE FIGURE

3.20	3.000	16	2SV-16	2-1437671-1
3.00	2.800	15	2SV-15	2-1437671-0
2.80	2.600	14	2SV-14	1-1437671-9
2.60	2.400	13	-	1-1437671-8
2.60	2.400	13	-	1-1437671-7
2.60	2.400	13	2SV-13	1-1437671-6
2.40	2.200	12	2SV-12	1-1437671-5
2.20	2.000	11	2SV-11	1-1437671-4
2.00	1.800	10	2SV-10	1-1437671-3
1.80	1.600	9	2SV-09	1-1437671-2
1.60	1.400	8	2SV-08	1-1437671-1
1.40	1.200	7	2SV-07	1-1437671-0
1.20	1.000	6	2SV-06	1437671-9
1.00	.800	5	2SV-05	1437671-7
.80	.600	4	2SV-04	1437671-6
.60	.400	3	2SV-03	1437671-4
.40	.200	2	-	1437671-2
.40	.200	2	2SV-02	1437671-1

2SV-07 AS SHOWN

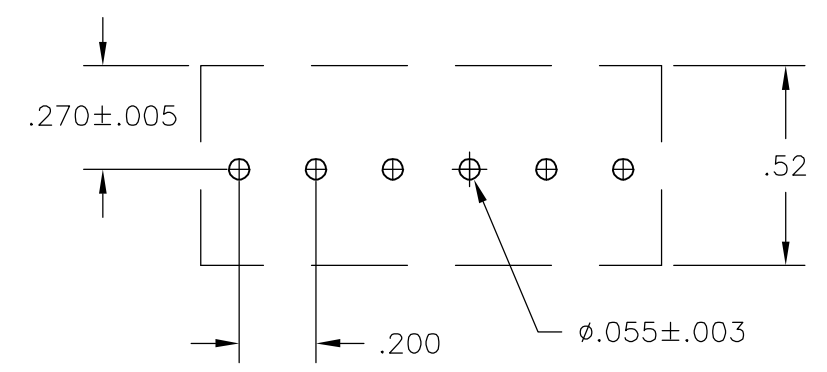

RECOMMENDED BOARD LAYOUT

THIS DRAWING IS A CONTROLLED DOCUMENT.		DWN S SCHLEGEL 14JUN02	Tyco Electronics Corporation Harrisburg, PA 17105-3608	
DIMENSIONS: INCHES		CHK C RICHARD 1/22/03		
TOLERANCES UNLESS OTHERWISE SPECIFIED:		APVD C RICHARD 1/22/03	NAME	
0 PLC ± -		PRODUCT SPEC	2SV 5.08mm SCREWLESS	
1 PLC ± -		APPLICATION SPEC	-	
2 PLC ± .01		SIZE	CAGE CODE	DRAWING NO
3 PLC ± .010		WEIGHT	A3	00779
4 PLC ± -		CUSTOMER DRAWING		RESTRICTED TO
ANGLES ± -		SCALE NTS		SHEET 1 OF 2
FINISH		DRAWING NO C-1437671-1		REV C

THIS DRAWING IS UNPUBLISHED. RELEASED FOR PUBLICATION
 © COPYRIGHT BY TYCO ELECTRONICS CORPORATION. ALL RIGHTS RESERVED.

LOC	DIST	REVISIONS					
FT	0	P	LTR	DESCRIPTION	DATE	DWN	APVD
				SEE SHEET 1			

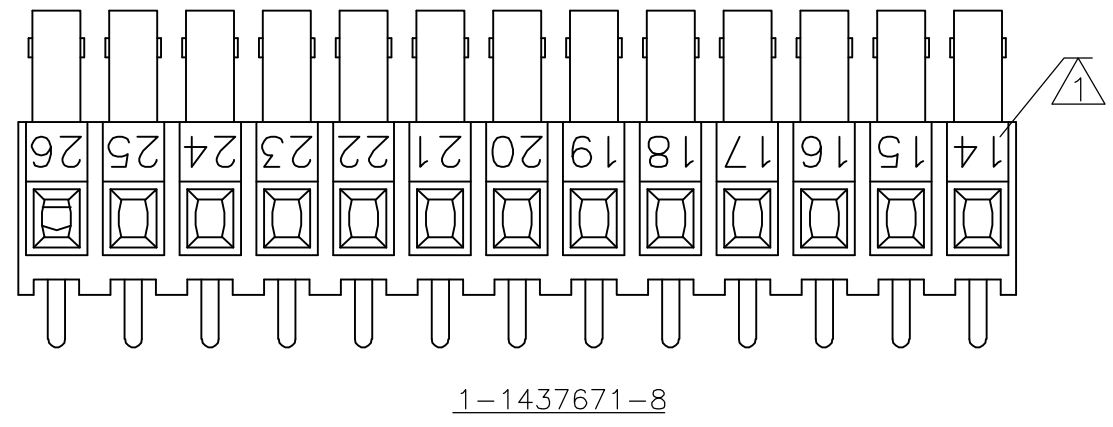
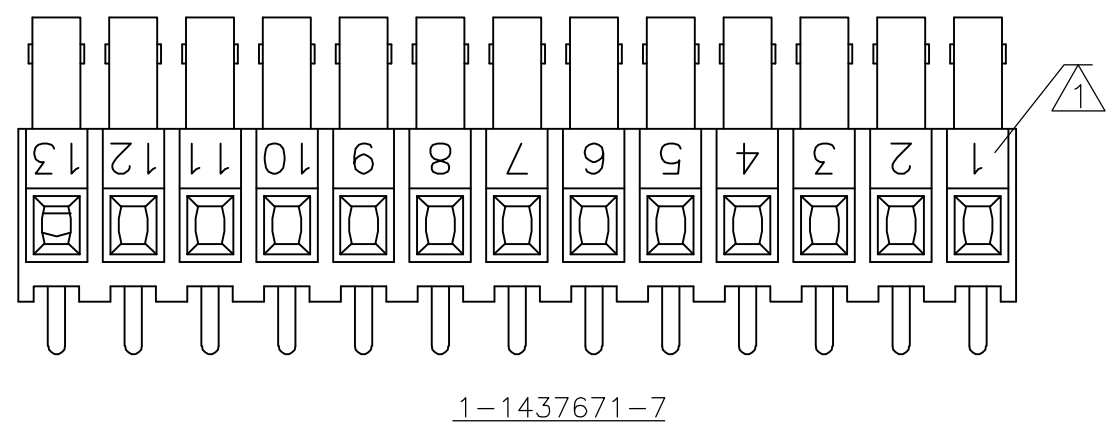
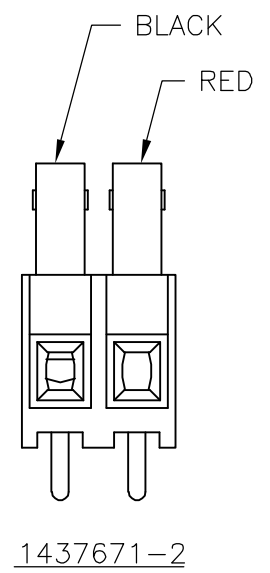

THIS DRAWING IS A CONTROLLED DOCUMENT.		DWN	S SCHLEGEL	14JUN02	tyco Electronics	Tyco Electronics Corporation	
DIMENSIONS: INCHES		CHK	C RICHARD	1/22/03		Harrisburg, PA 17105-3608	
TOLERANCES UNLESS OTHERWISE SPECIFIED:		APVD	C RICHARD	1/22/03	NAME		2SV 5.08mm SCREWLESS
0 PLC ± -		PRODUCT SPEC		-		-	
1 PLC ± -		APPLICATION SPEC		-		-	
2 PLC ± .01		SIZE	A3	CAGE CODE	00779	DRAWING NO	C=1437671-1
3 PLC ± .010		WEIGHT		-		RESTRICTED TO	
4 PLC ± -		CUSTOMER DRAWING		SCALE		NTS	
ANGLES ± -		FINISH		-		SHEET	
MATERIAL		-		-		2 OF 2	
-		-		-		REV	
-		-		-		C	