

ED Series



**UL Recognized
CSA Certified
VDE Approved**

*15ED1, 15ED8 -
UL, CSA 15 Amps/250 VAC
VDE 10 Amps/250 VAC

ED Series

The ED series filters are more effective than general-purpose filters in applications where line-to-line and low-frequency line-to-ground noise must be controlled; for example, to bring equipment into compliance with FCC conducted emissions standards.

The ED series offers significantly higher performance than comparably sized filters, especially at high frequencies, yet is in the EF series package which incorporates the IEC power line connector. Models ED1, ED1C, and ED2 have .250" terminals on load side; ED4, ED4C, ED8, and ED8C have wire leads.

Models 6ED1C, 10ED1C, 6ED4C, and 6ED8C additionally incorporate a separate ground-circuit inductor to isolate the equipment chassis from power line ground at RF frequencies.

Electrical Schematics

ED Models

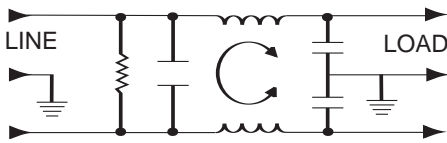

ED-C Models

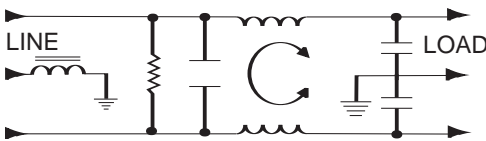

Resistor location for reference only.

Line Cord

Line Cord No. GA400:
7 1/2 foot, 3-conductor line cord to mate with ED series.



Specifications

Maximum leakage current, each line-to-ground	
@ 120 VAC 60 Hz:	.22 mA
@ 250 VAC 50 Hz:	.38 mA
Hipot rating (one minute):	
line-to-ground	1500 VAC
line-to-line	1450 VDC
Operating frequency:	50/60 Hz
Rated voltage (max.):	250 VAC
Minimum insertion loss in dB:	
Line-to-ground in 50 ohm circuit	

Current Rating	Frequency-MHz					
	.15	.5	1	5	10	30
ED1, ED2, ED4, ED8						
1A	24	35	42	49	52	54
3A	20	29	36	45	50	54
6A	14	23	30	41	45	50
10A	8	14	20	35	39	45
15A	4	9	12	28	34	40
ED1C						
6A	14	20	25	37	42	50
10A	8	14	20	35	39	45
ED4C, ED8C						
6A	14	20	25	37	42	50

Line-to-line in 50 ohm circuit

Current Rating	Frequency-MHz					
	.15	.5	1	5	10	30
ED1, ED2, ED4, ED8						
1A	3	15	20	37	37	36
3A	3	15	20	37	37	36
6A	3	15	20	31	35	34
10A	6	15	20	23	44	47
15A	6	18	23	33	44	47
ED1C						
6A	7	17	23	36	42	42
10A	6	15	20	23	44	47
ED4C, ED8C						
6A	7	17	23	29	38	42

ED Series

Case Styles

ED1 & ED1C

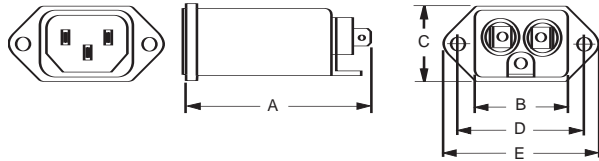

ED2

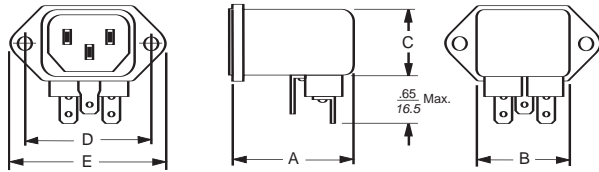

Typical dimensions:
Terminals: .250 [6.35] (3) Holes: .07 [1.8] Dia.(2) Slot: .07 x .16 [1.8 x 4.1]

ED4 & ED4C

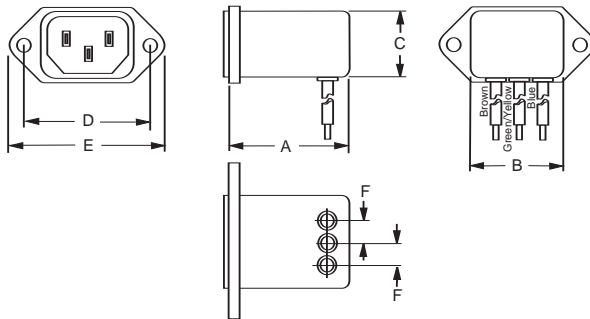

ED8 & ED8C

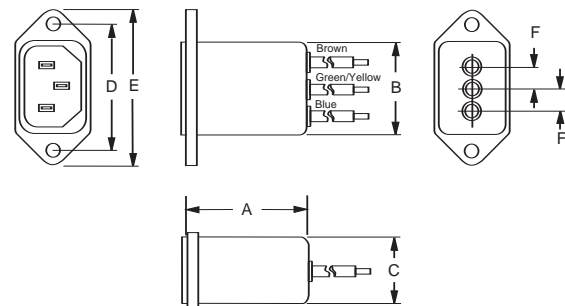

Typical dimensions:
Wire leads: 4.0 [101.6] Min., 18 AWG Mounting holes: .132 [3.35] Dia. (2)

Recommended Panel Cutouts

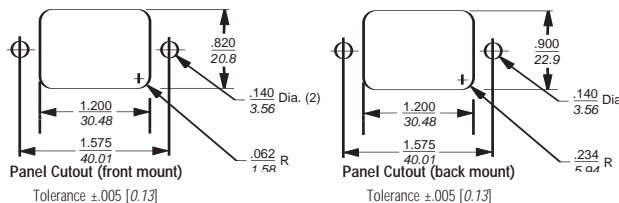

Note 1: ED1, ED1C, ED8 and ED8C allow front or back mounting.
Note 2: ED2, ED4 and ED4C allow back mounting only.

Case Dimensions

Part No.	A (max)	B (max)	C (max)	D $\pm .015$ $\pm .38$	E (max)	F (ref)
1ED1,	2.21	1.19	0.81	1.575	1.98	—
3ED1	56.0	30.2	20.6	40.01	50.3	—
1ED2,	1.55	1.19	0.85	1.575	1.98	—
3ED2	39.4	30.2	21.6	40.01	50.3	—
1ED4,	1.55	1.19	0.85	1.575	1.98	.295
3ED4	39.4	30.2	21.6	40.01	50.3	7.5
1ED8,	1.55	1.19	0.81	1.575	1.98	.295
3ED8	39.4	30.2	20.6	40.01	50.3	7.5
6ED1	2.21	1.19	0.81	1.575	1.98	—
	56.0	30.2	20.6	40.01	50.3	—
6ED1C	2.62	1.19	0.81	1.575	1.98	—
	66.5	30.2	20.6	40.01	50.3	—
6ED2	1.55	1.19	0.85	1.575	1.98	—
	39.4	30.2	21.6	40.01	50.3	—
6ED4	1.55	1.19	0.85	1.575	1.98	.295
	39.4	30.2	21.6	40.01	50.3	7.5
6ED4C	1.98	1.19	0.85	1.575	1.98	.295
	50.3	30.2	21.6	40.01	50.3	7.5
6ED8	1.55	1.19	0.81	1.575	1.98	.295
	39.4	30.2	20.6	40.01	50.3	7.5
6ED8C	1.98	1.19	0.81	1.575	1.98	.295
	50.3	30.2	20.6	40.01	50.3	7.5
10ED1,	2.62	1.19	0.81	1.575	1.98	—
15ED1*	66.5	30.2	20.6	40.01	50.3	—
10ED1C	2.62	1.19	0.81	1.575	1.98	—
	66.5	30.2	20.6	40.01	50.3	—
15ED8*	1.98	1.19	0.81	1.575	1.98	—
	50.3	30.2	20.6	40.01	50.3	—

Part Numbers

1ED1	6ED2
1ED2	6ED4
1ED4	6ED4C
1ED8	6ED8
3ED1	6ED8C
3ED2	10ED1
3ED4	10ED1C
3ED8	15ED1*
6ED1	15ED8*
6ED1C	

Line Cord No.	GA400
Insulating Boot No.	FA601

*15ED1, 15ED8 - UL, CSA VDE
15 Amps/250 VAC
10 Amps/250 VAC