

RFI Power Line Filters for UL2601 Healthcare Equipment

H Series



**UL Recognized
CSA Certified
VDE Approved***

H Series

The H series filters were developed specifically for health care applications. These products are suitable for uses in both patient care equipment and non-patient care equipment. Their extremely low leakage current allows compliance with UL2601 and CSA 22.2 health care specifications.

See Appendix C for more information on UL544 health care applications.

The H series features products with a variety of current ratings and case styles. Model 10EH4C additionally incorporates a separate ground circuit inductor to isolate equipment chassis from power line ground at RF frequencies.

For more information on UL2601, see Appendix C.

Note: When using the models with an IEC connector (e.g. 6EH4), remember that the leakage current of the companion line cord, GA400, is more significant than that of the filter – which may disqualify this line cord from use in patient care applications.

*15EH4 - VDE rated at 10 amps, 250 VAC

Electrical Schematic

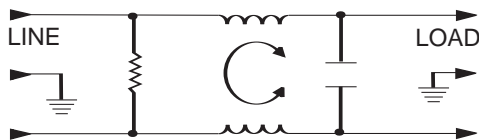

Resistor location for reference only.



Specifications

Maximum leakage current, each line-to-ground	
@ 120 VAC 60 Hz:	2µA
@ 250 VAC 50 Hz:	5µA
Hipot rating (one minute):	
line-to-ground	2250 VDC
line-to-line	1450 VDC
Operating frequency:	50/60 Hz
Rated voltage (max.):	250 VAC
Minimum insertion loss in dB:	
Line-to-ground in 50 ohm circuit	

Current Rating	Frequency-MHz					
	.15	.5	1	5	10	30
3A	18	27	30	30	27	18
6A	9	16	20	26	23	18
10A	7	13	15	17	16	14
15A	5	9	11	12	11	9

Line Cord

Line Cord No. GA400:
SVT type 7^{1/2} foot, 3-conductor line cord to mate with all models except EH1. 50 micro amps maximum leakage @120 VAC, 60 Hz.

Case Style

EH1

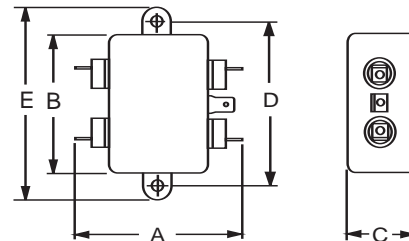

Typical dimensions:
Terminals: .250 [6.35] (5) Holes: .07 [1.8] Dia.(4) Slot: .07 x .16 [1.8 x 4.1]
Mounting holes: .188 [4.78] Dia. (2)

H Series

Case Styles

EH3

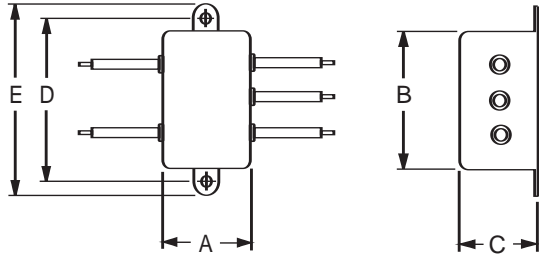

Typical dimensions:
Wire leads: 4.0 [101.6] Min. 18 AWG Mounting holes: .188 [4.78] Dia. (2)

EH4 & EH4C

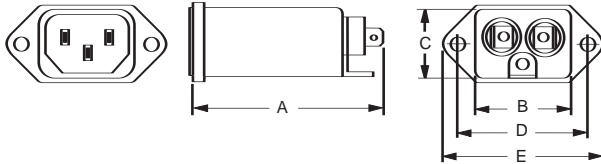

EH9

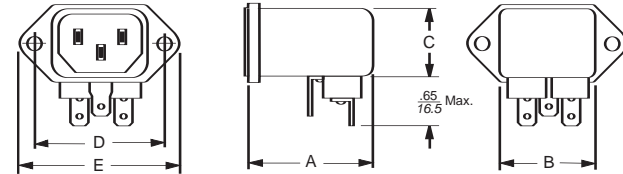

Typical dimensions:
Terminals: .250 [6.35] (3) Holes: .07 [1.8] Dia.(2) Slot: .07 x .16 [1.8 x 4.1]
Mounting holes: .132 [3.35] Dia. (2)

EH5

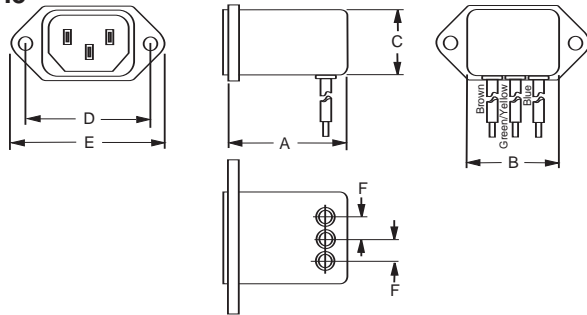

EH8

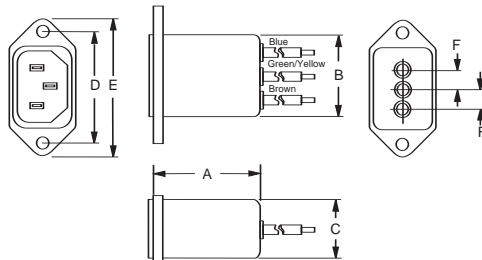

Typical dimensions:
Wire leads: 4.0 [101.6] Min. 18 AWG Mounting holes: .132 [3.35] Dia. (2)

Case Dimensions

Part No.	A (max)	B (max)	C (max)	D $\begin{smallmatrix} \pm .015 \\ \pm .38 \end{smallmatrix}$	E (max)	F (ref)
3EH1	2.25	1.82	0.66	2.125	2.53	—
6EH1	57.2	46.1	16.7	53.98	64.2	—
10EH1						
3EH3	.96	1.82	0.66	2.125	2.53	—
6EH3	24.40	46.1	16.7	53.98	64.2	—
10EH3						
6EH4	2.20	1.19	0.81	1.575	1.98	—
	55.9	30.2	20.6	40.01	50.3	—
6EH5	1.55	1.19	0.85	1.575	1.98	.295
	39.4	30.2	21.6	40.01	50.3	7.5
6EH8	1.56	1.19	0.81	1.575	1.98	.295
	39.7	30.2	20.6	40.01	50.3	7.5
6EH9	1.55	1.19	0.85	1.575	1.98	—
	39.4	30.2	21.6	40.01	50.3	—
10EH4	2.62	1.19	0.81	1.575	1.98	—
	66.5	30.2	20.6	40.01	50.3	—
10EH4C	2.62	1.19	0.81	1.575	1.98	—
	66.5	30.2	20.6	40.01	50.3	—
15EH4	2.62	1.19	0.81	1.575	1.98	—
	66.5	30.2	20.6	40.01	50.3	—

Part Numbers

3EH1	6EH8
3EH3	6EH9
6EH1	10EH1
6EH3	10EH3
6EH4	10EH4
6EH5	10EH4C
	15EH4*

Line Cord No. GA400
Insulating Boot No. (EH4, EH4C) FA601

*UL, CSA — 15A; VDE — 10A

Recommended Panel Cutouts

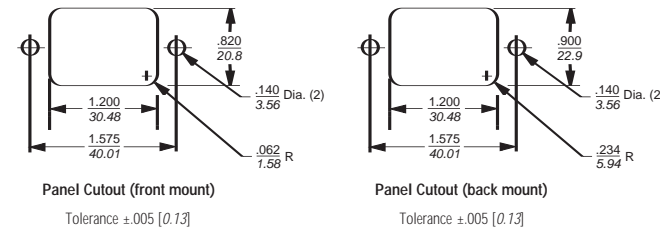

Note 1: EH4, EH4C and EH8 allow front or back mounting.
Note 2: EH5 and EH9 allow back mounting only.