

NUMBER C-175151



METRIC

単位: mm DIMENSIONS IN MM. DO NOT SCALE PRINT

PRINT DIST

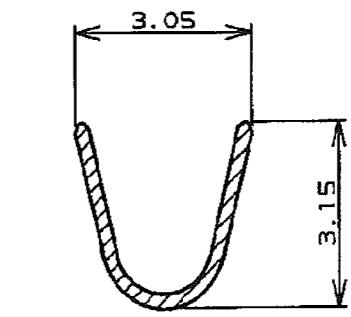
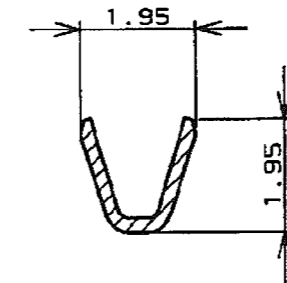
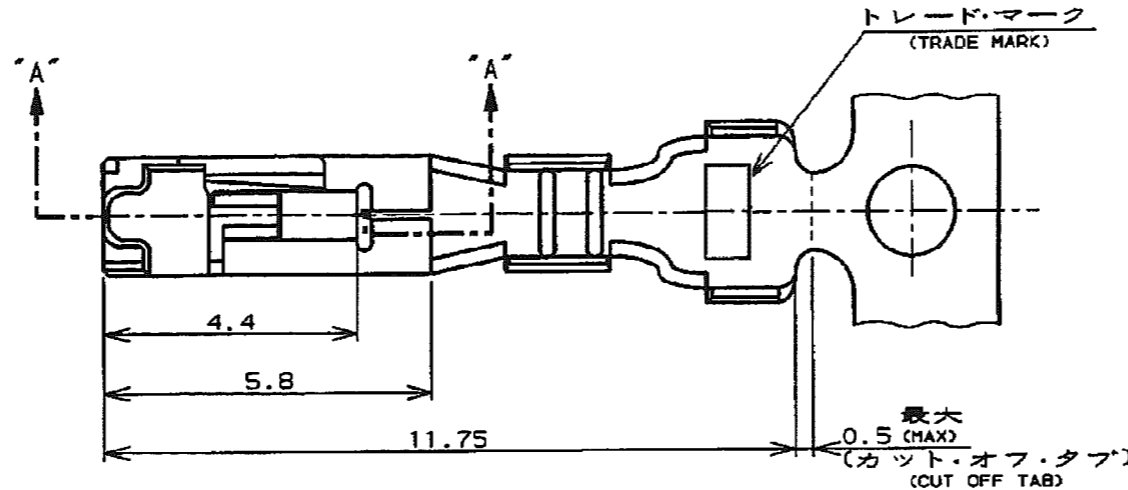

断面 "D"- "D"  
(SECT)

断面 "E"- "E"  
(SECT)

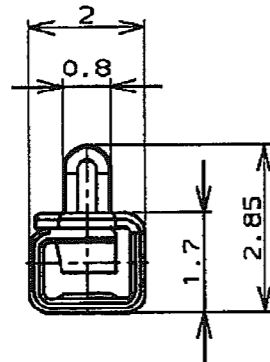

断面 "B"- "B"  
(SECT)

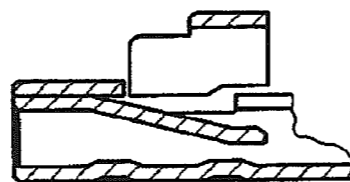
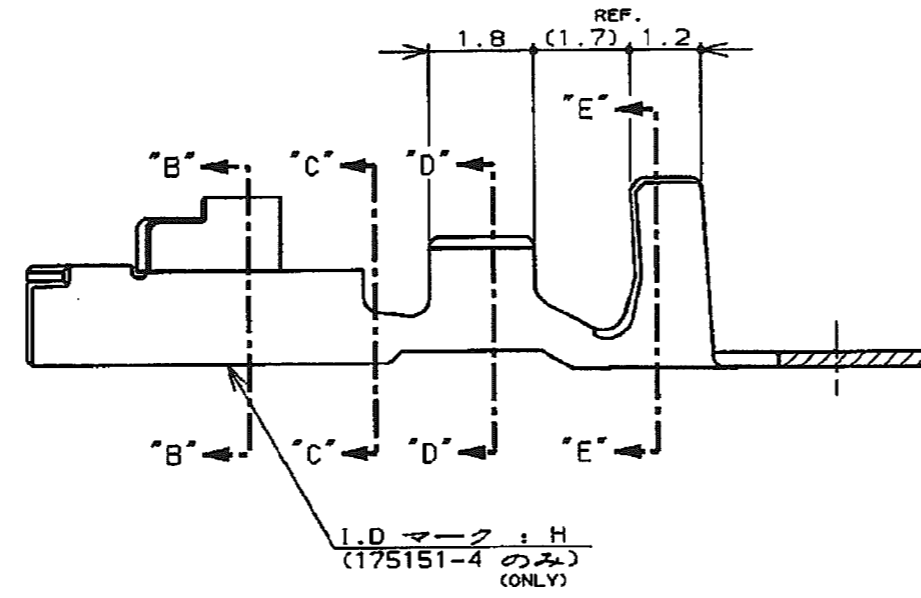

断面 "A"- "A"  
(SECT) (175151-1, -2)

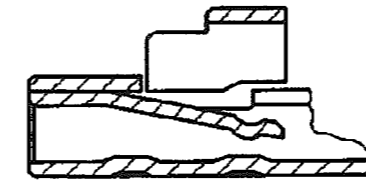

断面 "A"- "A"  
(SECT) (175151-4)

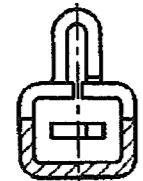

断面 "C"- "C"  
(SECT)

注記:

- 1. 適用規格
  - 製品規格 : 108-5302
  - 取付適用規格 : 114-5142
- 2. 取扱説明書 : IS-503J

NOTES:

- 1. APPLICABLE SPEC
  - PRODUCT SPEC : 108-5302
  - APPLICATION SPEC : 114-5142
- 2. INSTRUTION SHEET : IS-503J

	NYE: 502H-20-UV 1L7"カトオ化処理 (APPLIED LUBRICANT OIL)	錫めつき黄銅 (PRE TINNED BRASS)	175151-5
175155-4	---	錫めつき黄銅合金 (PRE TINNED COPPER ALLOY)	175151-4
175155-2	---	錫めつき黄銅 (PRE TINNED BRASS)	175151-2
175155-1	---	錫めつき黄銅合金 (PRE TINNED COPPER ALLOY)	175151-1
バラ状端子型番 (L.P P/N)	仕上 (FINISH)	材料 (MATERIAL)	型番 (P/N)

F1	REVISED PER ECO-11-005030	RK	HMR	01APR11
LTR	変更 (REVISION RECORD)	DR	CHK	DATE

適合電線断面積 (WIRE RANGE) 0.12~0.35mm <sup>2</sup> (AWG#26~22)		被覆外径 (INSULATION DIA.) 1.2~2 mmφ	名称 (NAME) リセパクル・コンタクト、アンプ・ユニバーサル・パワー・コネクタ (REC CONTACT AMP UNIVERSAL POWER CONN.)
材料 (MATERIAL) 表参照 (SEE TABLE)	仕上 (FINISH) 表参照 (SEE TABLE)	一般公差 (GENERAL TOLERANCE) 10以下: ±0.2 10を超え30以下: ±0.25 30を超え100以下: ±0.3 角 度: ±3°	LOD 番号(No.) B J C-175151
DR. 8. JUN '95 N. NAGASHIMA	DE. 8. JUN '95 M. SHINDO	尺度 (SCALE)	REV. F1 SHEET 1 OF 1
CHK. 8. JUN '95 M. SHINDO	APP. 8. JUN '95 Y. KASHIWA		