

NUMBER C-179609



METRIC

DIMENSIONS IN MILLIMETERS. DO NOT SCALE PRINT

PRINT DIST

MATE 0.6 DIA POST  
Ø0.6ポストと嵌合

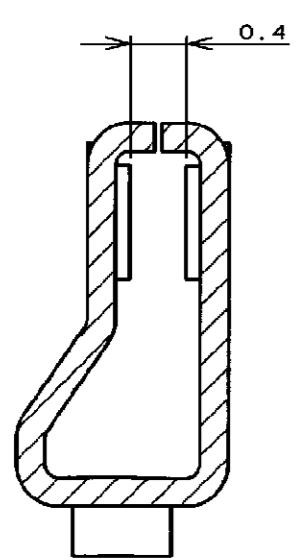
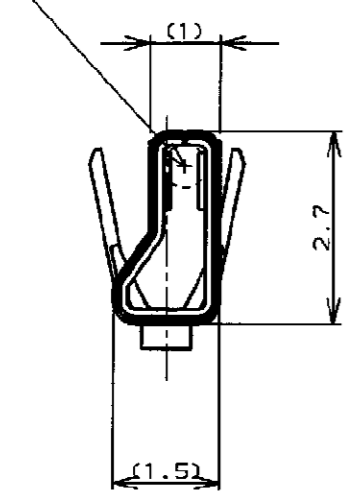

SECT "C" - "C"  
(SCALE 20-1)

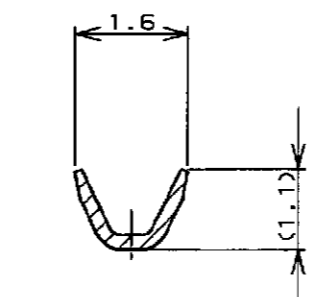
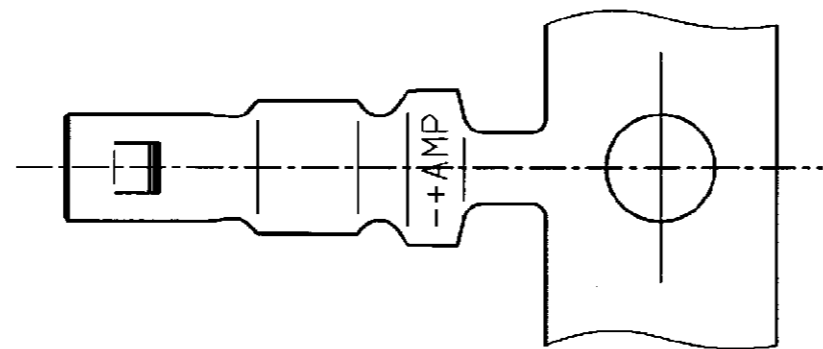
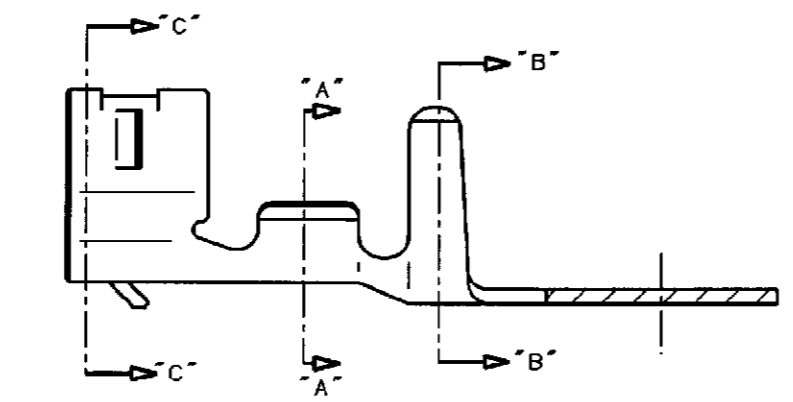
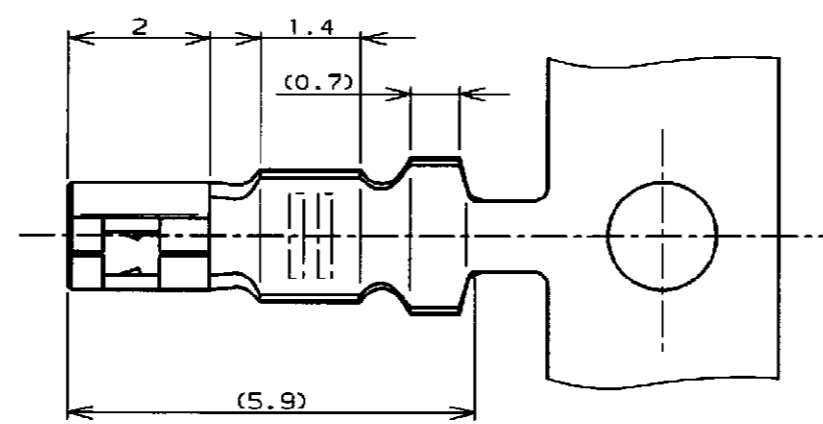

SECT "A" - "A"

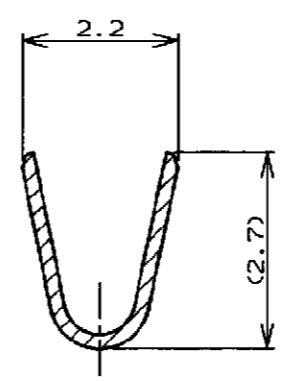

SECT "B" - "B"

注:

1. 使用ハウジングは型番 179228
2. 製品規格: 108-5408
3. 取付適用規格: 114-5179

NOTES,

1. USE HOUSING ; P/N 179228
2. PRODUCT SPEC ; 108-5408
3. APPLICATION SPEC ; 114-5179

PRE TINNED PHOSPHOR BRONZE (0.2t) 錫めっき赤磷黄銅、(板厚0.2)	179609-1
MATERIAL & FINISH 材質	PART NO. 型番



WIRE RANGE 0.05 ~0.12 mm <sup>2</sup> (AWG30-26)	INSULATION DIA 0.65-1.35 mmφ	NAME 圧着タイプIIリセコンタクト CRIMP TYPE II RECEPTACLE CONTACT (AMP CT CONNECTOR 2mm PITCH)		
MATERIAL SEE TABLE 表参照	FINISH SEE TABLE 表参照	GENERAL TOLERANCE	SIZE	LOC
DR. T. FURUYA 1/23 '95	DE. T. FURUYA 1/23 '95	0<≦10 : ±0.2 10<≦30 : ±0.25 30<≦100 : ±0.3 ANGLES : ±3°	B	J
LTR	REVISION RECORD	DR. S. KUBOUCHI 1/23 '95	APP. S. Kubouchi 1/23 '95	NUMBER C-179609
B2	REVISED PER ECO-11-005294	DR. HMR 5APR11	CHK. S. KUBOUCHI 1/23 '95	SCALE 10-1
				REV. B2
				SHEET 1 OF 1