

1825093-2 Product Details

[Share](#) [Print](#) [Email](#)

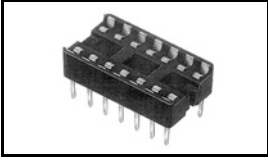

1825093-2

TE Internal Number: 1825093-2

 Active

 [View 3D PDF](#)

DIP Sockets

 Always EU RoHS/ELV Compliant
(Statement of Compliance)

Product Highlights:

- Socket Style = Standard
- Through Hole Contact Termination Type
- 2.54 mm Centerline
- Row-to-Row Spacing = 7.62 mm
- 8 Positions

[View all Features](#)

Quick Links

- ▶ [Pricing & Availability](#)
- ▶ [Search for Tooling](#)
- ▶ [Product Feature Selector](#)
- ▶ [Contact Us About This Product](#)

[Add to My Part List](#)

[Request Sample](#)

[Find Similar Products](#)

[Buy Product](#)

Documentation & Additional Information

Product Drawings:

- [DIP SOCKET ASSY, CLOSED, DIPLOMATE, .300 CL, LEAD FREE](#) (PDF, English)

Catalog Pages/Data Sheets:

- None Available

Product Specifications:

- None Available

Application Specifications:

- [DIPLOMATE Dual Leaf \(DL\) Low-Profile DIP Sockets](#) (PDF, English)

Instruction Sheets:

- None Available

CAD Files: (CAD Format & Compression Information)

- [2D Drawing](#) (DXF, Version A)
- [3D Model](#) (IGES, Version A)
- [3D Model](#) (STEP, Version A)

[List all Documents](#)

Additional Information:

- [Product Line Information](#)

Related Products:

- [Tooling](#)

Product Features (Please use the Product Drawing for all design activity)

Product Type Features:

- [Socket Style](#) = Standard
- Profile = Standard
- [Frame Style](#) = Closed
- [Leg Style](#) = Straight
- Color = Black

Electrical Characteristics:

- Insulation Resistance (MΩ) = 10,000
- Contact Resistance (mΩ) = 30

Termination Features:

- [Contact Termination Type](#) = Through Hole
- [Termination Post Length \(mm \[in\]\)](#) = 3.25 [0.128]
- Solder Tail Contact Plating = Tin

Dimensions:

- [Height Above PC Board \(mm \[in\]\)](#) = 5.33 [0.210]

Housing Features:

- [Centerline \(mm \[in\]\)](#) = 2.54 [0.100]
- Housing Material = Thermoplastic - GF
- UL Flammability Rating = UL 94V-0

Configuration Features:

- [Number of Positions](#) = 8

Industry Standards:

- [RoHS/ELV Compliance](#) = RoHS compliant, ELV compliant
- [Lead Free Solder Processes](#) = Wave solder capable to 240°C, Wave solder capable to 260°C, Wave solder capable to 265°C
- [RoHS/ELV Compliance History](#) = Always was RoHS compliant

Conditions for Usage:

Body Features:

- [Row-to-Row Spacing \(mm \[in\]\)](#) = 7.62 [0.300]
- [Mount Style](#) = Vertical

Contact Features:

- [Contact Base Material](#) = Phosphor Bronze
- [Contact Plating, Mating Area, Material](#) = Gold (15)
- [Contact Style](#) = Stamped + Formed
- [Mating Contact Type](#) = Dual Leaf

- [Temperature Range \(°C\)](#) = 125

Operation/Application:

- [Application](#) = Production

Packaging Features:

- [Packaging Method](#) = Tube

Other:

- [Brand](#) = TE Connectivity
- [Proprietary Name](#) = DIPLOMATE DL
- [Comment](#) = ONLY sockets with straight solder tails are recommended for automatic insertion.

Corporate Information

[About TE](#)
[Investors](#)
[News Room](#)
[Supplier Portal](#)
[Careers](#)
[Terms & Conditions](#)
[Privacy Policy](#)

Quick Links

[Distributor Inventory](#)
[Product Cross Reference](#)
[Documents & Drawings](#)
[Product Compliance Support Center](#)
[Site Map](#)

Customer Support

[Email or Chat With Us](#)
[Find a Phone Number](#)
[Knowledge Base](#)
[Manage Your Account](#)

Keep Me Informed

1. RECEPTACLE ACCEPTS A .008-.014 THICK I.C. LEAD.
2. TUBE LOADED FOR AUTOMATIC INSERTION.
3. BECU CONTACT-PLATED WITH TWO .000030 MIN THK. GOLD STRIPES IN CONTACT AREA WITH TIN ON CONTACT LEGS, BALANCE OF CONTACT NICKEL PLATED.
4. PHOS. BRONZE CONTACT- PLATED WITH TWO .000015 MIN THK. GOLD STRIPES IN CONTACT AREA WITH TIN ON CONTACT LEGS, BALANCE OF CONTACT NICKEL PLATED.
5. MAXIMUM DIMENSION FOR I.C. SEATING PLANE.
6. HOUSING MATERIAL-GLASS FILLED THERMOPLASTIC, BLACK, 94V-0

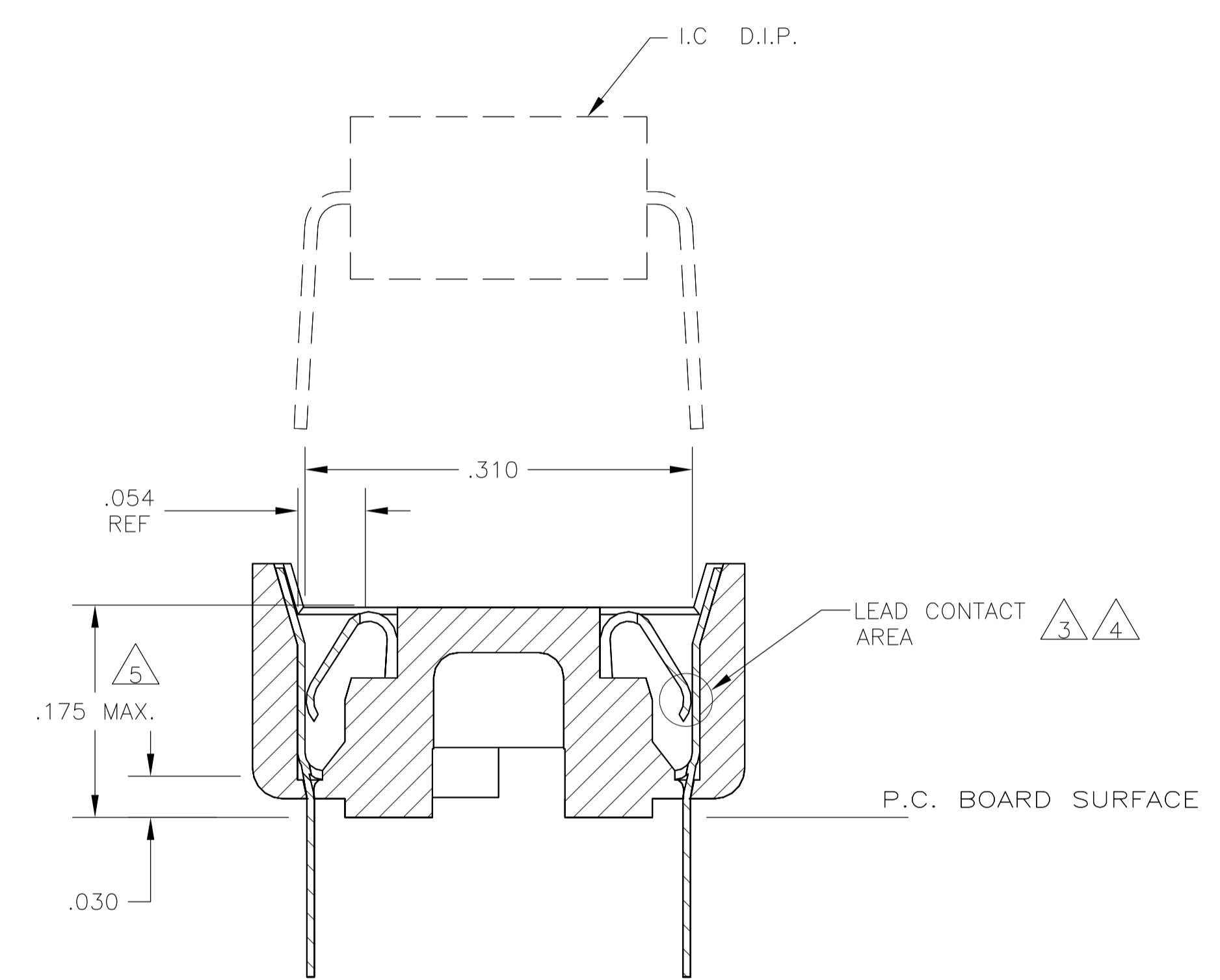
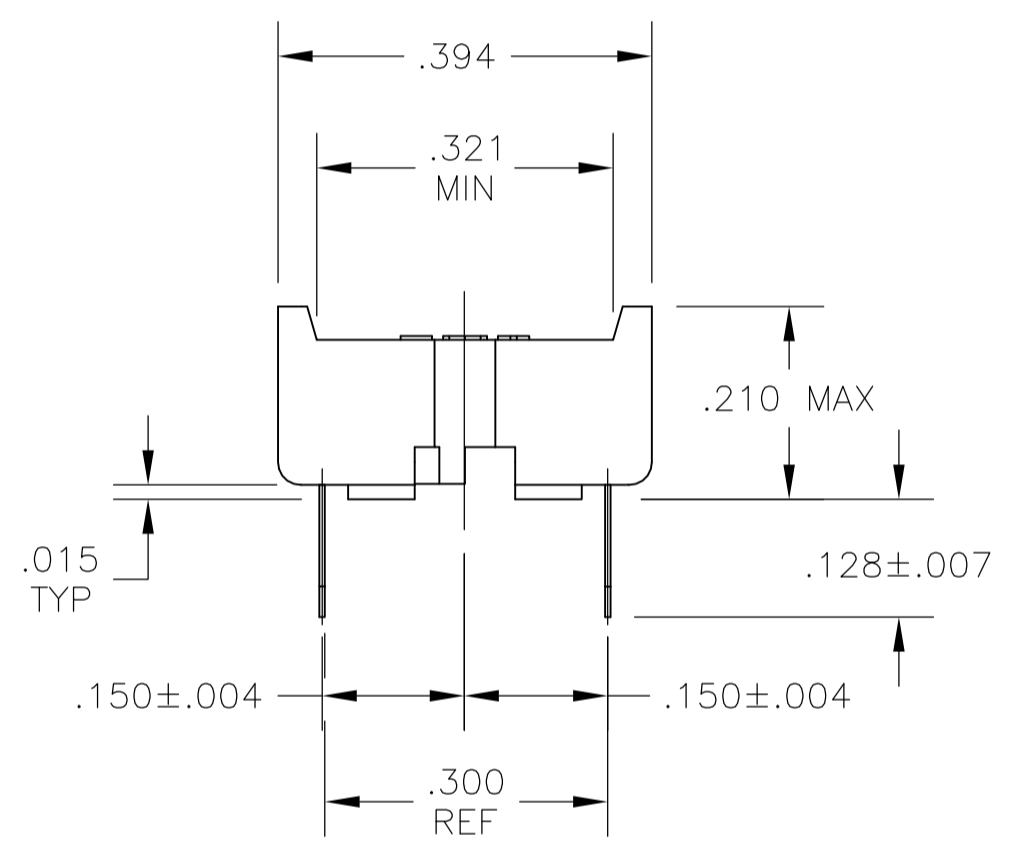
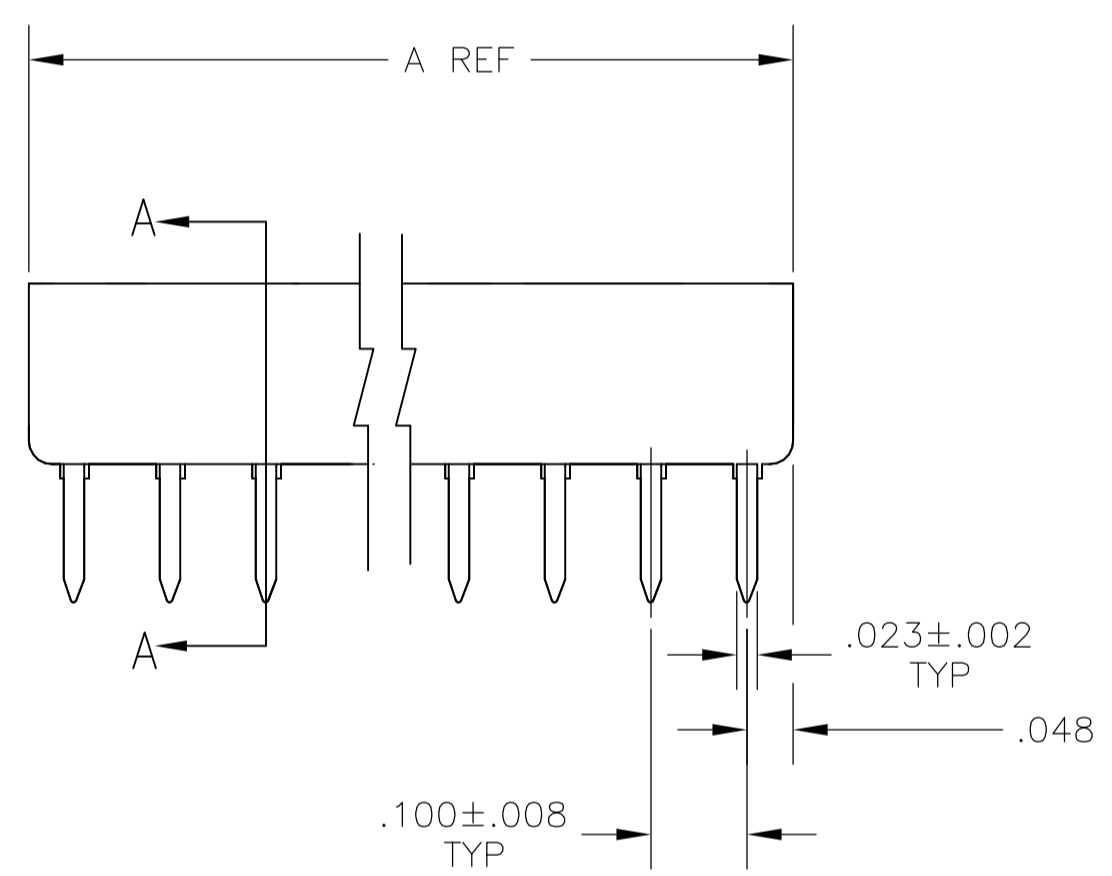
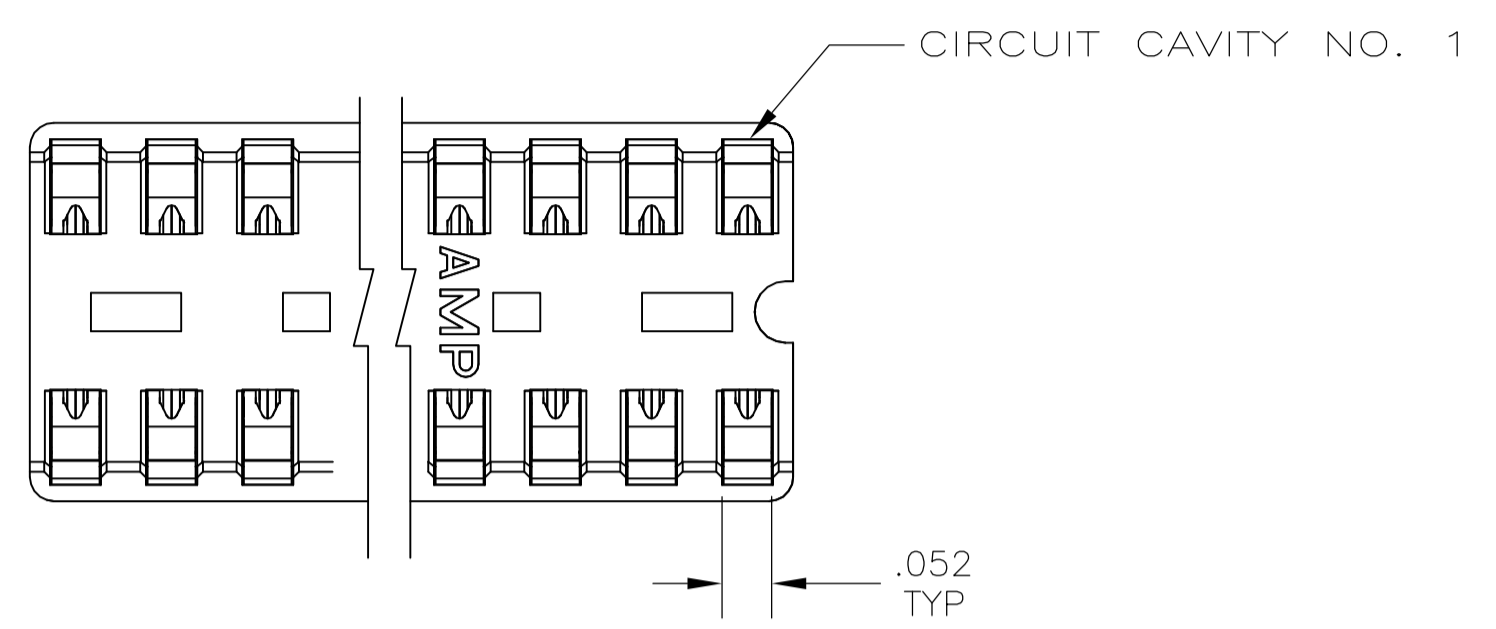

SECTION A-A
SCALE 10:1

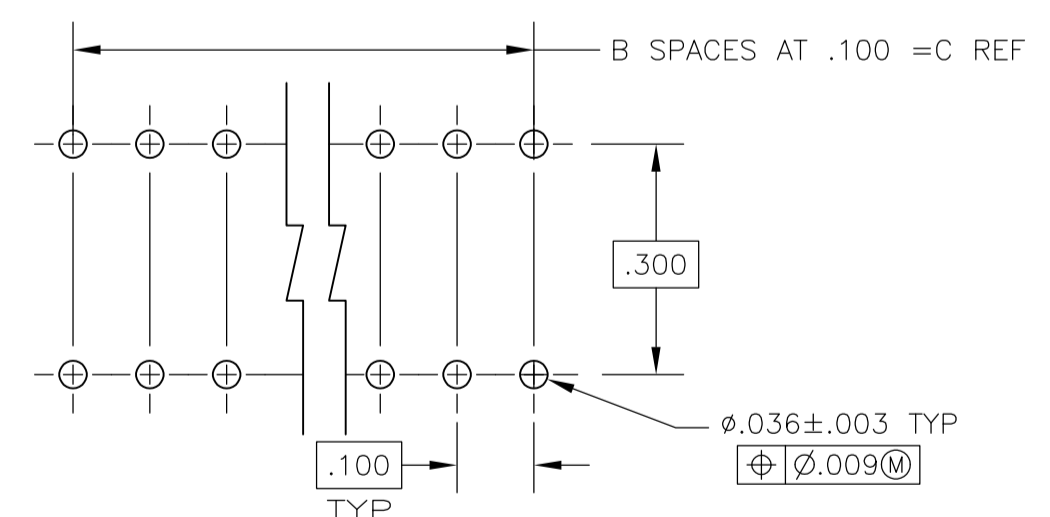

RECOMMENDED MOUNTING HOLE PATTERN
SCALE 4:1

CONTACT & FINISH	DIM C	B SPCS	DIM A	POSITION	PART NO.
3	.900	9	.995	20	1-1825093-6
3	.800	8	.895	18	1-1825093-5
3	.700	7	.795	16	1-1825093-4
3	.600	6	.695	14	1-1825093-3
3	.300	3	.395	8	1-1825093-2
3	.200	2	.295	6	1-1825093-1
4	.900	9	.995	20	1825093-6
4	.800	8	.895	18	1825093-5
4	.700	7	.795	16	1825093-4
4	.600	6	.695	14	1825093-3
4	.300	3	.395	8	1825093-2
4	.200	2	.295	6	1825093-1

THIS DRAWING IS A CONTROLLED DOCUMENT.

DIMENSIONS: INCHES

TOLERANCES UNLESS OTHERWISE SPECIFIED:

0. PLC	± .005
1. PLC	± .004
2. PLC	± .003
3. PLC	± .002
4. PLC	± .001
ANGLES	± .001

MATERIAL: - FINISH: -

THIS DRAWING IS A CONTROLLED DOCUMENT.

DIN: B.S.VISWESWARA

CHK: K.WRIGHT

APVD: -

NAME: -

PRODUCT SPEC: -

APPLICATION SPEC: -

WEIGHT: -

CUSTOMER DRAWING

SCALE: 5:1 SHEET: 1 OF 1 REV: A1

STE TE Connectivity

DIP SOCKET ASSY, CLOSED, DIPLOMATE, .300 CL, LEAD FREE

SIZE: A1 CAGE CODE: 00779 DRAWING NO: 1825093