

LOC		DIST		REVISIONS			
		P	LTM	DESCRIPTION	DATE	DWN	APVD
		B		RELEASED PER ECO-13-004502	12MAR2013	KM	DH
		C		REVISED PER ECO-13-008265	20MAY2013	DB	DH

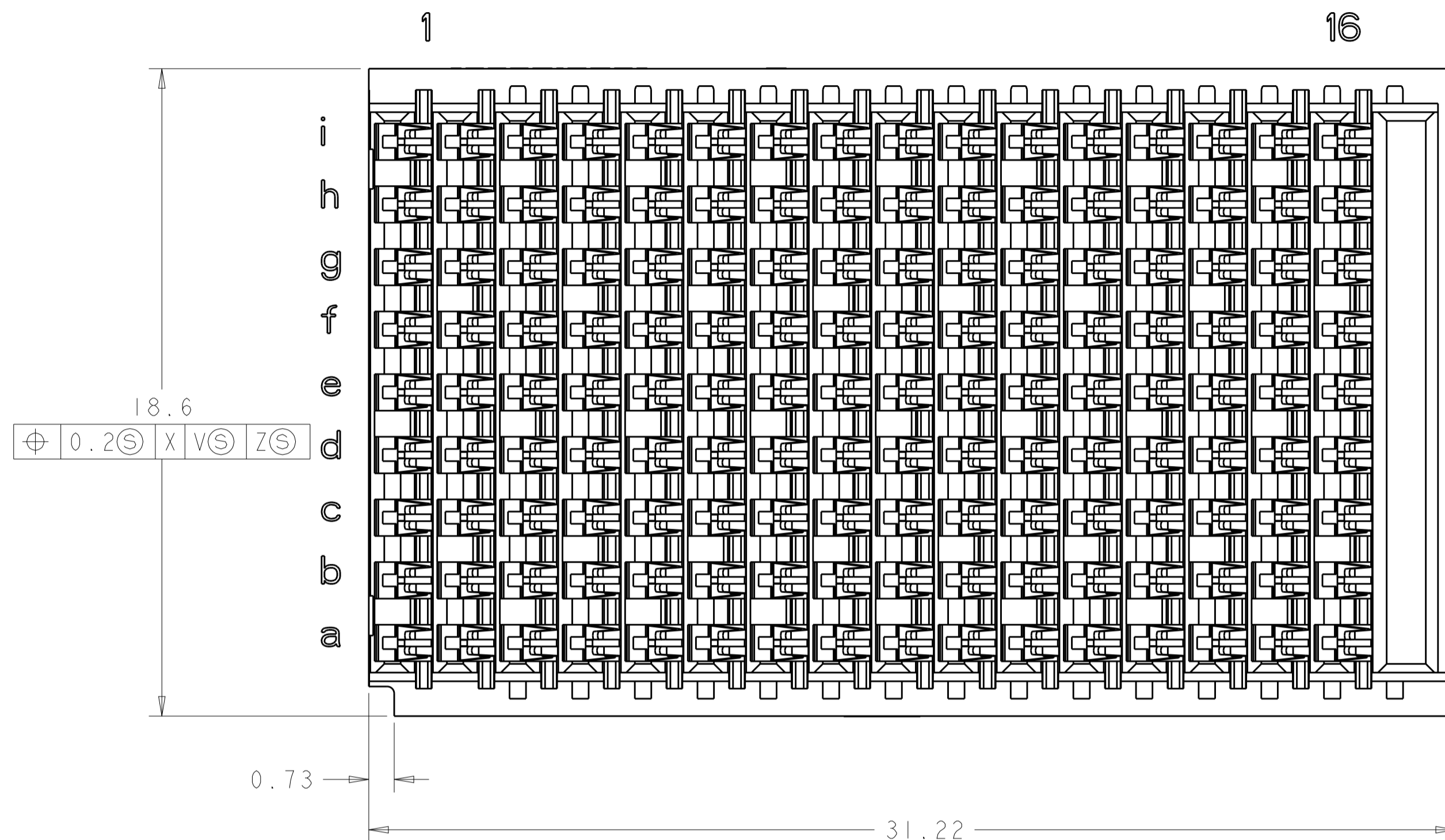

- △ HOUSING: LCP, UL94V0, COLOR: BLACK. CONTACT: PHOSPHOR BRONZE.
- △ FINISH: 1.27µm GOLD IN CONTACT AREA 1.27µm MIN. TIN-LEAD ON PCB TAIL OVER 2.54µm MIN. NICKEL OVER ALL.
- △ PLATED THROUGH HOLE PER 114-13056, FIGURE 4
- △ ADDITIONAL CONNECTOR-SIDE KEYPOT AREA REQUIRED IF CONNECTOR-SIDE EXTRACTION TOOL IS TO BE USED.
- △ FINISH: 1.27µm MIN GOLD IN CONTACT AREA, 0.50µm MIN TIN ON PCB TAIL OVER 2.54µm MIN. NICKEL OVER ALL.

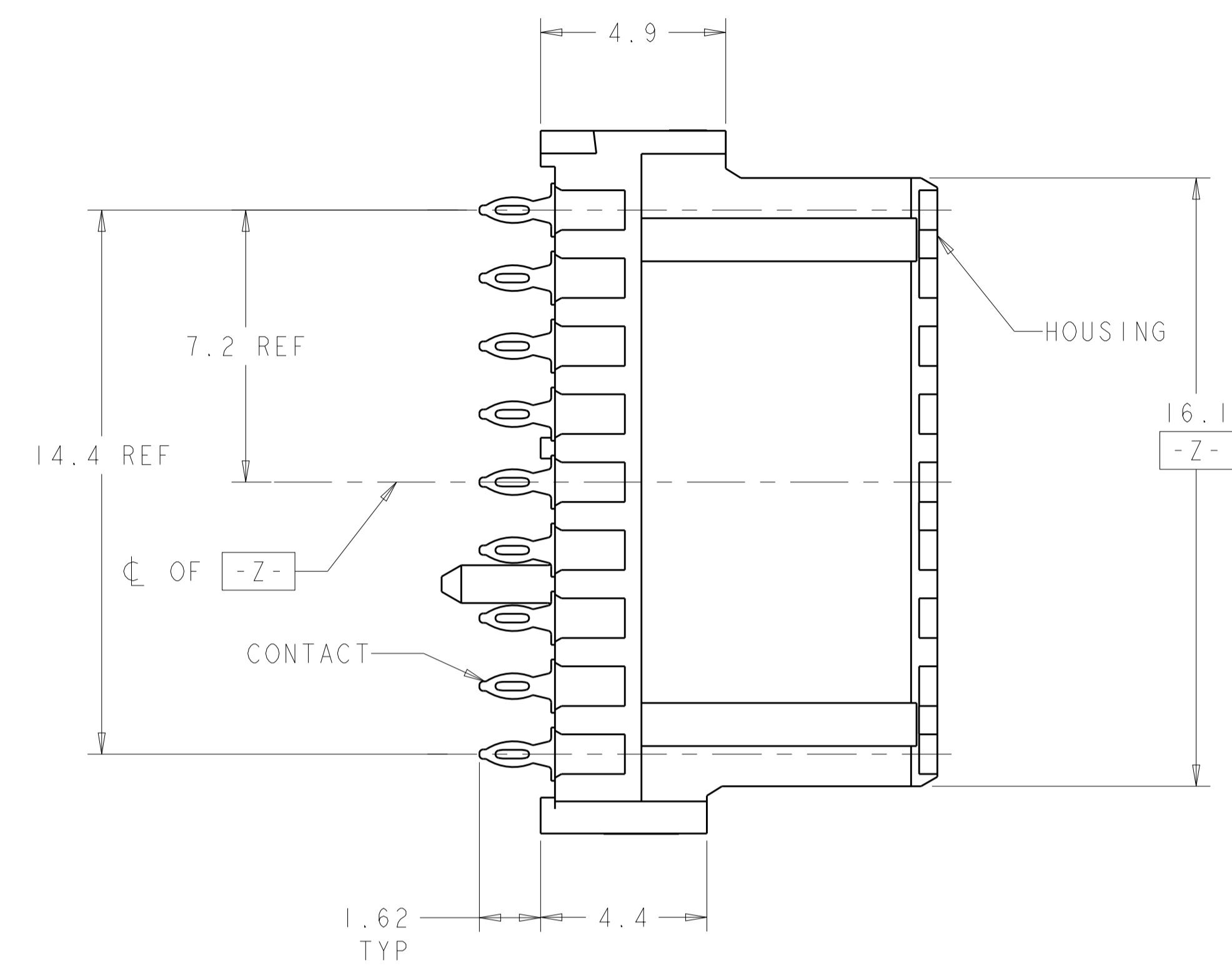
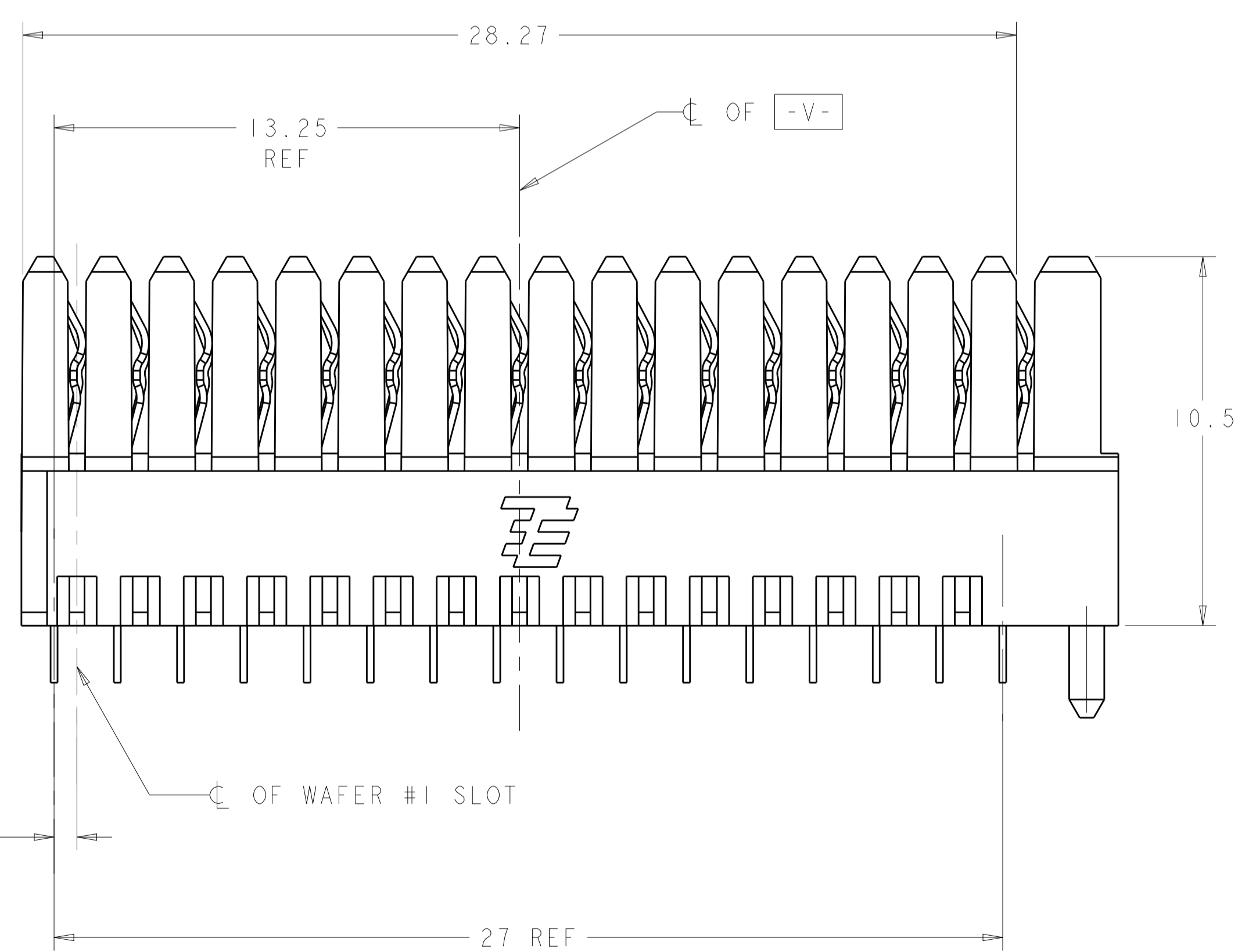
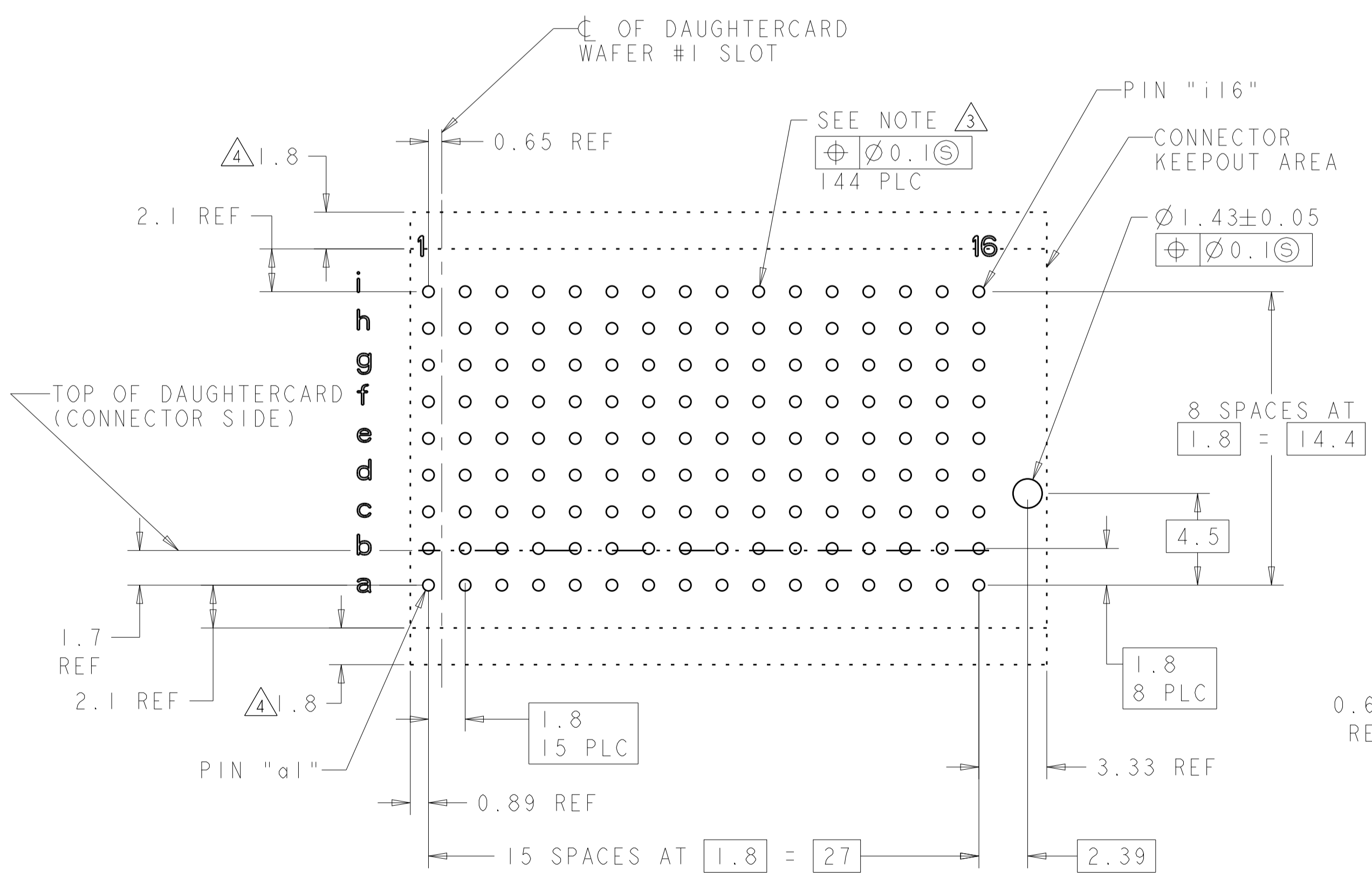

PC BOARD LAYOUT (CONNECTOR SIDE)  
 (SEE SHEET 2 FOR RTM)  
 SCALE 5:1

△ 5	2102737-2
△ 4	2102737-1
PLATING	PART NO

THIS DRAWING IS A CONTROLLED DOCUMENT.		DWN: R. MILLER 07SEP2011	TE Connectivity
DIMENSIONS: mm		CHK: K. THACKSTON 12SEP2011	
TOLERANCES UNLESS OTHERWISE SPECIFIED:		APVD: M. McALONIS 10SEP2012	NAME: CONNECTOR ASSEMBLY, BACKPLANE VERTICAL RECEPTACLE, RIGHT END, 20.3mm, MULTIGIG RT 2-R SIZE: CAGE CODE DRAWING NO. RESTRICTED TO A100779C=2102737
0 PLC ±0.5		PRODUCT SPEC: 108-2072	
1 PLC ±0.13		APPLICATION SPEC: 114-13056	
2 PLC ±0.13		WEIGHT: 6.97g	
3 PLC ±0.13		Customer Drawing	SCALE: 3:1 SHEET 1 OF 2 REV C
4 PLC ±0.13			
ANGLES: ±1°			
MATERIAL: SEE TABLE			

LOC		DIST		REVISIONS			
				REV	DATE	BY	APPV
-	-	-	-	1	SEE SHEET 1	-	-

# REAR TRANSITION MODULE APPLICATION

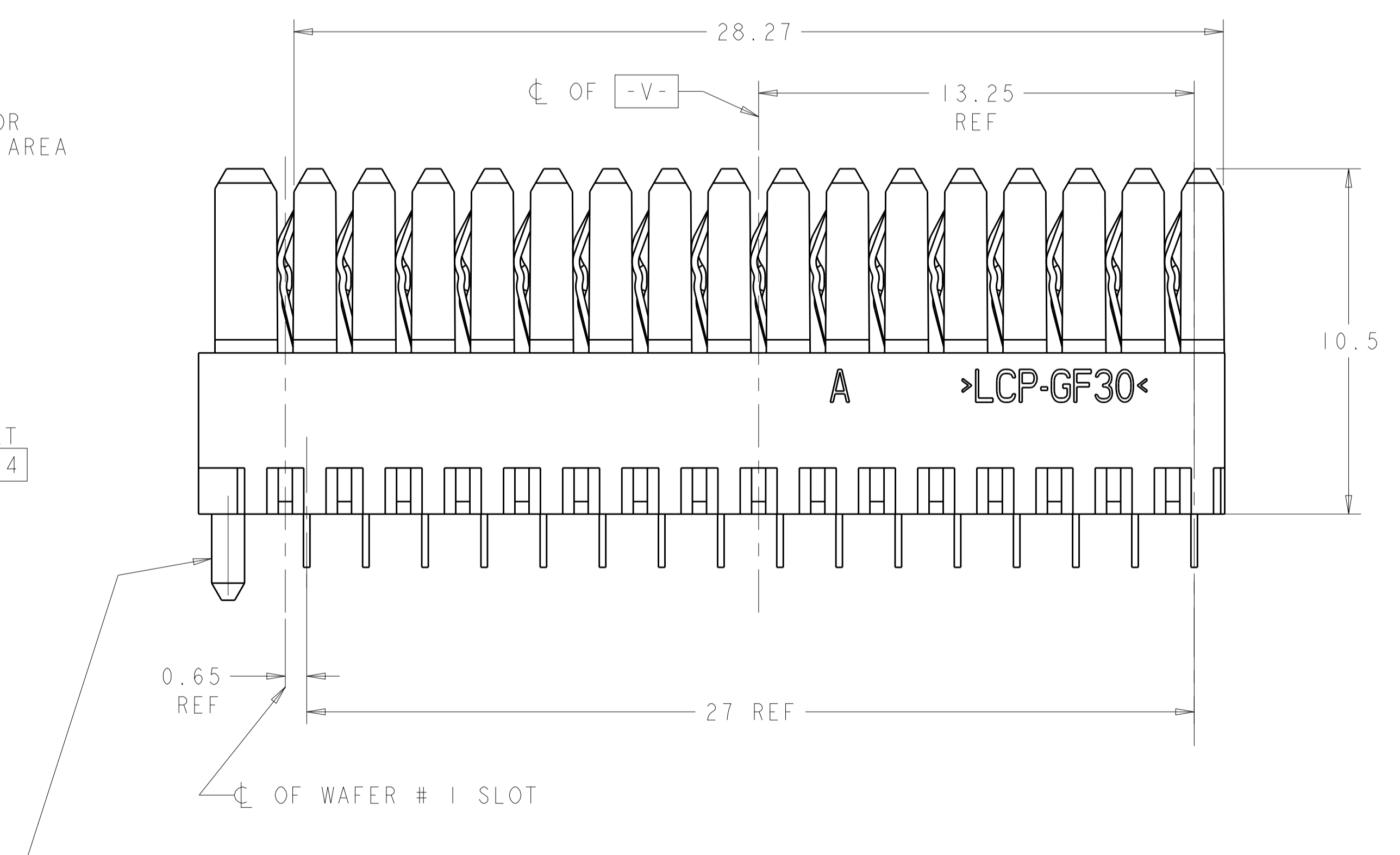
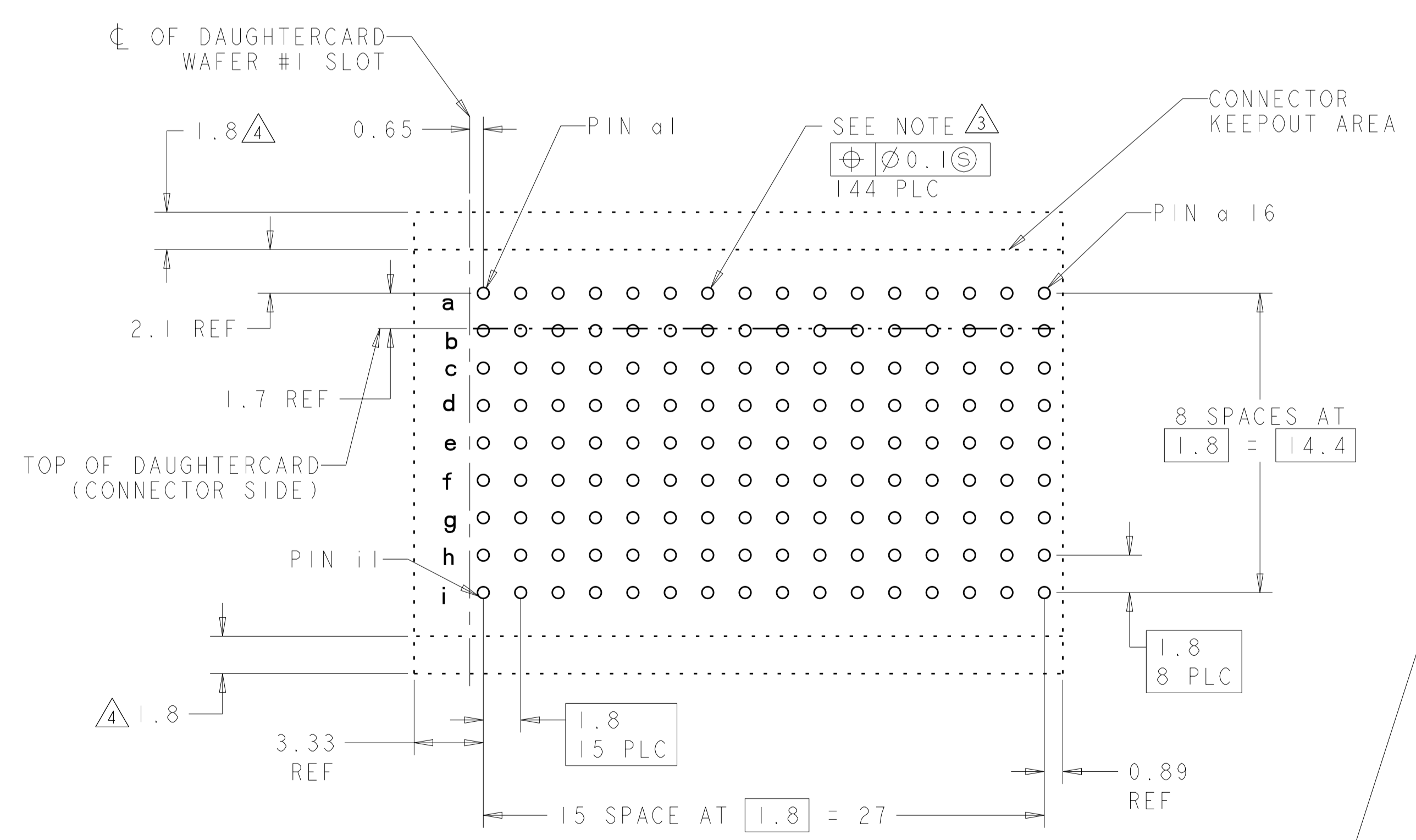
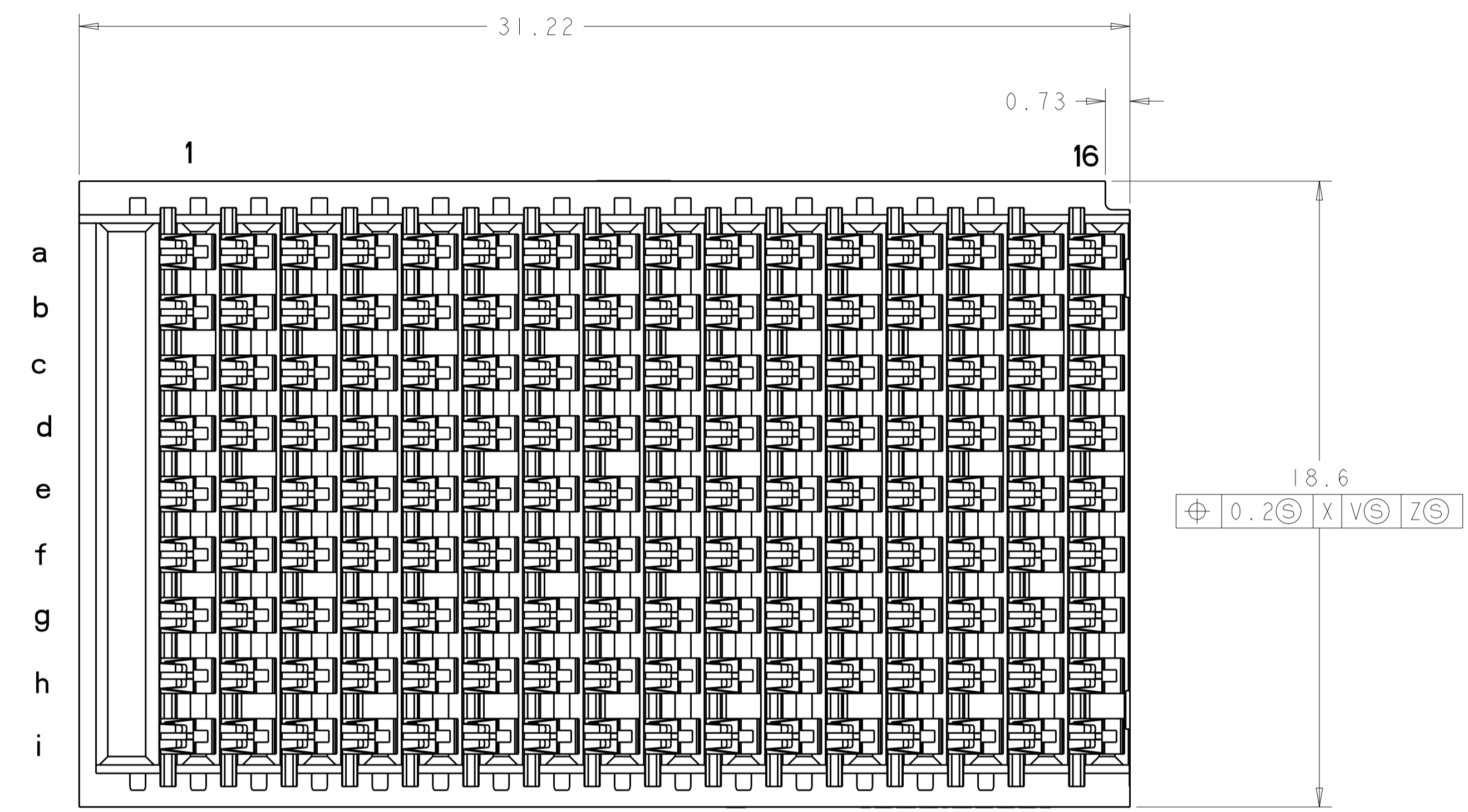
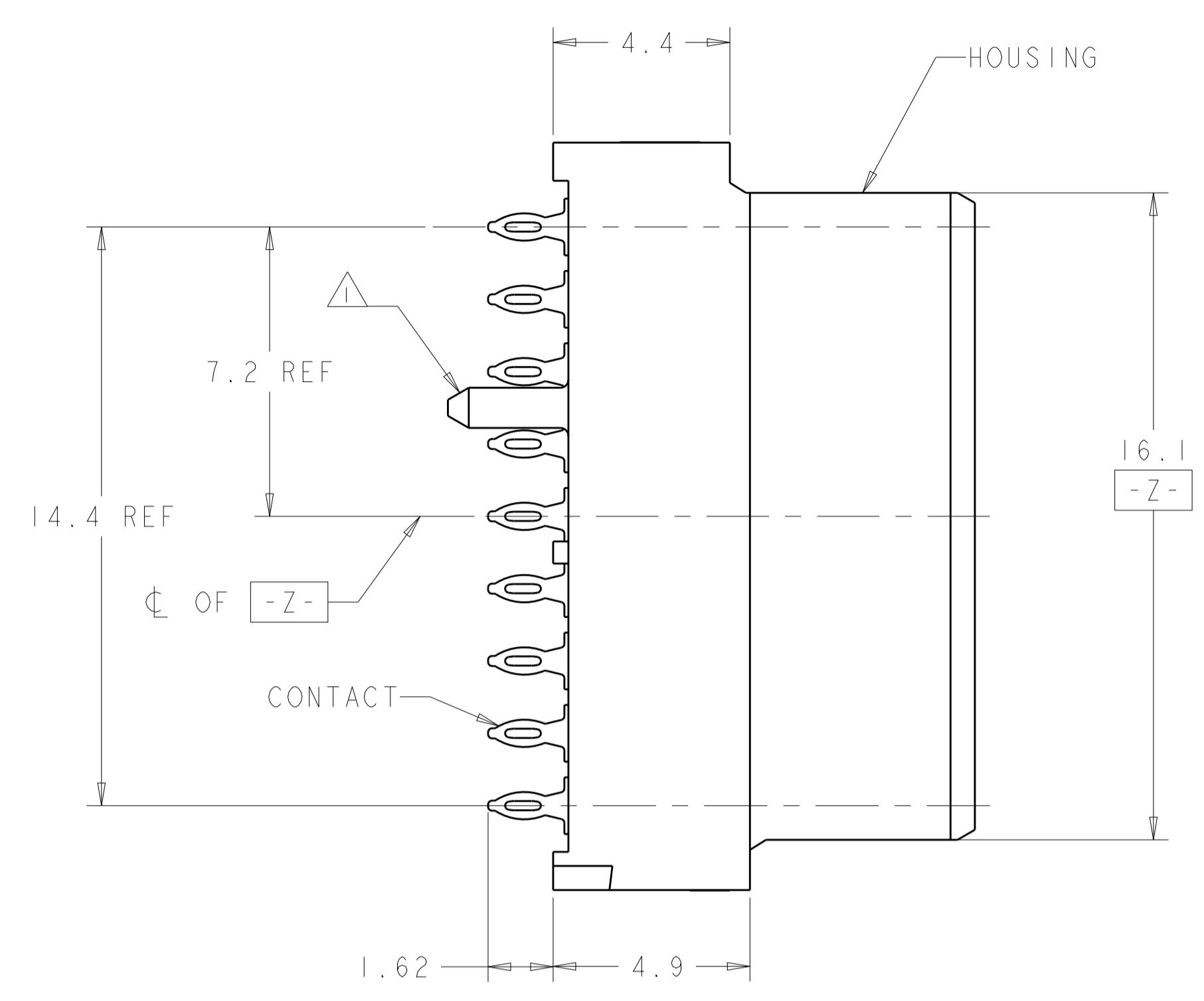

PLASTIC ALIGNMENT PIN MUST BE REMOVED FLUSH TO HOUSING BODY PRIOR TO INSERTION INTO RTM LAYOUT

PC BOARD REAR TRANSITION MODULE (CONNECTOR SIDE) SCALE 5:1

THIS DRAWING IS A CONTROLLED DOCUMENT.		OWN: R. MILLER 07SEP2011	TE Connectivity
DIMENSIONS: mm		CHK: K. THACKSTON 12SEP2011	
TOLERANCES UNLESS OTHERWISE SPECIFIED:		APPV: M. McALONIS 10SEP2012	NAME: CONNECTOR ASSEMBLY, BACKPLANE VERTICAL RECEPTACLE, RIGHT END, 20.3mm, MULTIGIG RT 2-R
0 PL C ±0.13		PRODUCT SPEC: 108-2072	SIZE: A1
1 PL C ±0.5		APPLICATION SPEC: 114-13056	CAGE CODE: 2102737
2 PL C ±0.13		WEIGHT: 6.97g	RESTRICTED TO: -
3 PL C ±0.13		Customer Drawing	SCALE: 3:1
4 PL C ±0.13			SHEET: 2 OF 2
ANGLES: ±1°			REV: C