



MIL-C-5015 Style Circular Plastic Connectors (CPC)

Product Facts

- Intermateable with other manufacturers' Metal-Shell Sizes 20-14 and 18-10, MIL-C-5015 Style Connectors
- High impact resistant plastic housing
- Lighter weight
- Lower cost
- Industry accepted, Type III+ pin and socket contacts, available on reels in strip-form for high volume, low cost, automatic machine terminations
- Contacts also available in loose piece form for low volume, prototype or maintenance and repair
- Housing designed to prevent mismatching with other insert arrangements
- Recognized under the Component Program of Underwriters Laboratories Inc., File No. E28476 
- Certified by Canadian Standards Association, File No. LR 7189 



This new addition to the AMP Circular Plastic Connector Line is specifically designed to be intermateable with other manufacturers' Metal-Shell sizes 20-14 and 18-10, MIL-C-5015 Style Connector Systems. The high impact resistant plastic housing offers the advantages of lighter weight and lower cost than existing metal shell connectors. In addition, the connector design prevents mismatching when used with other insert arrangements. As part of the AMP Multimate Family of Connectors, the MIL-C-5015 style connector offers the additional economies of crimp Type III+ Pin and Socket contacts in reel-mounted, strip-form for high volume automatic machine termination, as well as in loose piece form for low volume, prototype or maintenance and repair.

Technical Documents

- Application Specification**
114-10004 Contacts, Type III+
- Product Specifications**
108-10024 CPC Connectors
108-10042 Contacts, Type III+
- Instruction Sheets**
408-7582 Accessories for CPC Connectors
408-7592-A Improved Strain Relief Clamps for CPC Connectors
408-7593 CPC Connectors

MIL-C-5015 Style Circular Plastic Connectors (CPC), Shell Size 20-14

Plug Kit, Unassembled

Reverse Sex (Accepts pins)
Part Number 213571-2
without Cable Clamp

Standard Sex (Accepts sockets)
Part Number 213652-1
without Cable Clamp

Cable Clamps	O.D.	
Part No.	Type	Max.
206070-8	standard	.453 [11.51]
206322-9	large	.703 [17.86]

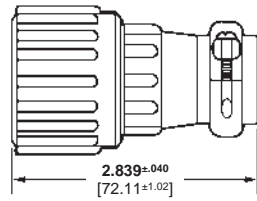

Assembled with Cable Clamp

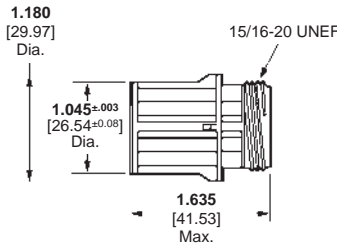
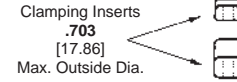
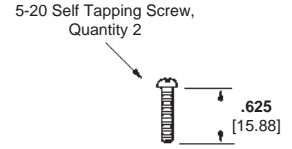

Standard Sex

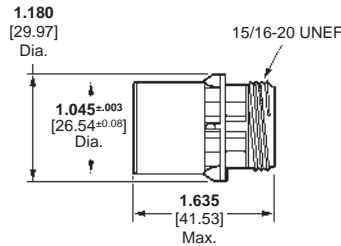

Reverse Sex

Receptacle, Square Flange

Reverse Sex (Accepts sockets)
Part Number 213570-1

Standard Sex (Accepts pins)
Part Number 213651-1

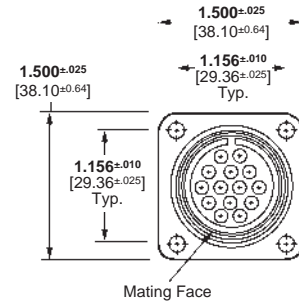

Mating Face

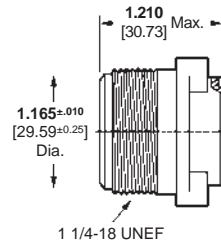

Reverse Sex

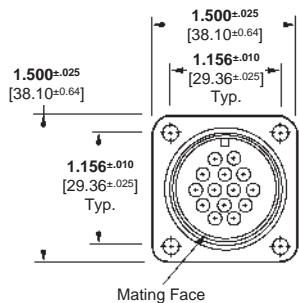

Mating Face

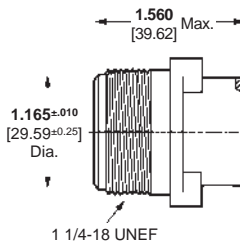

Standard Sex

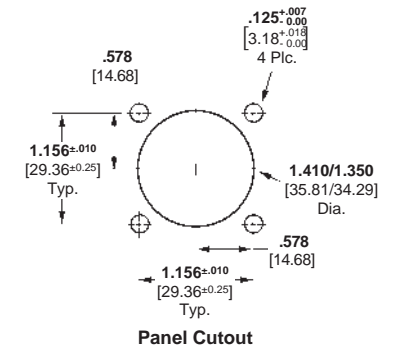

Panel Cutout

Receptacle, Free-Hanging

Reverse Sex (Accepts sockets)
Part Number 213650-1

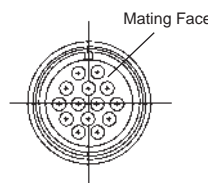

Mating Face

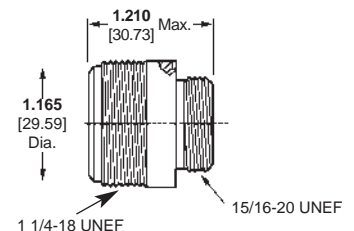

Electronics

MIL-C-5015 Style Circular Plastic Connectors (CPC), Shell Size 18-10

Plug Kit, Unassembled

Reverse Sex (Accepts pins)
Part Number 213671-1
without Cable Clamp

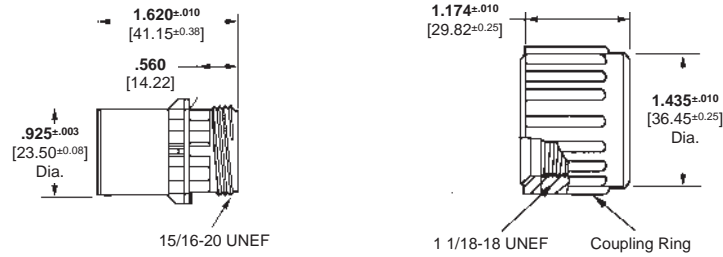

Receptacle, Square Flange

Reverse Sex (Accepts sockets)
Part Number 213667-1

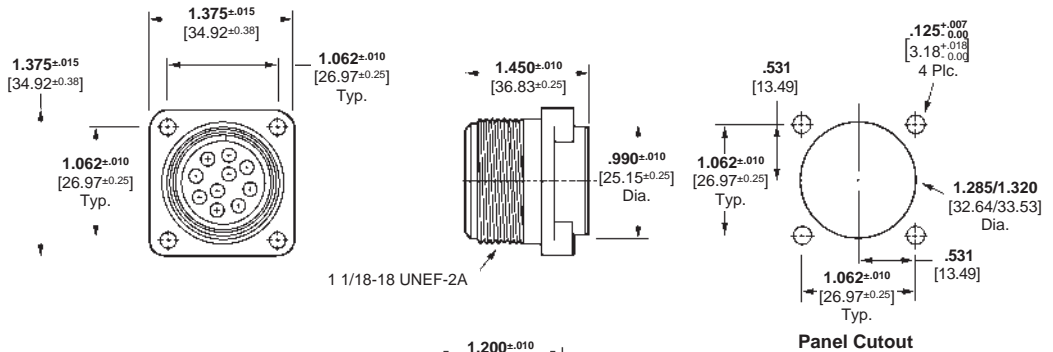

Receptacle, Free-Hanging

Reverse Sex (Accepts sockets)
Part Number 213668-1

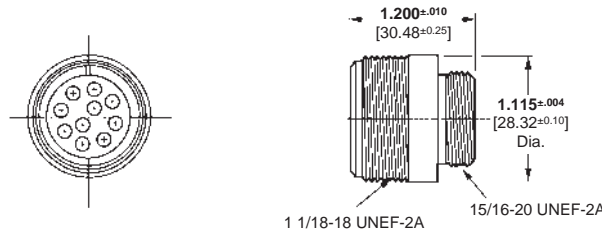

Type III+ Contacts

Material

Contact—Brass
Spring—Stainless Steel

Contact Finish

A—.000030 [0.00076] gold on the electrical engagement area over .000030 [0.00076] min. nickel
B—Tin

Related Product Data

Application Tooling—Pages 75-78

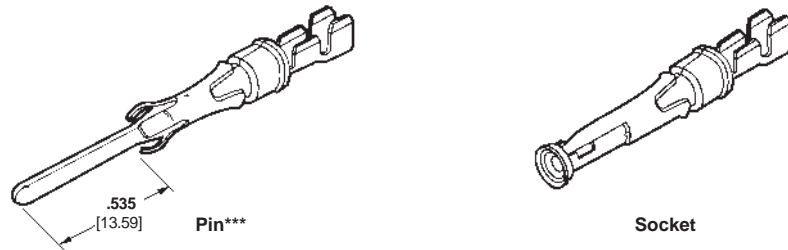

Wire Size Range AWG mm ²	Ins. Dia. Range	Contact Finish Code	Strip Form Contact No.		Loose Piece Contact No.		Strip Form Applicator	Hand Tool Part No.
			Pin	Socket	Pin	Socket		
24-20 0.2-0.6	.060-.135 1.52-3.43	B	213605-7	1-66563-1	—	66565-7	567363-□ ^{††}	91542-1 ⁵
		A	—	66563-8	—	66565-4		
18-14 0.8-2	.110-.150 2.79-3.81	B	213603-5	66598-9	213603-6	66601-9	466958-1 ^{††} (for Sockets) or 567364-□ ^{††}	91521-1 ⁵
		A	213603-3	66598-2	213603-4	66601-2		

^{††}Note: Applicators for AMP semiautomatic or fully-automatic termination equipment are available. Contact Technical Support.

^{***}MIL-C-5015 style connectors require a longer Multimate pin contact. This contact is .145 [3.68] longer than the standard Multimate pin contacts. It is **not** for use in other Multimate connectors, socket contacts are standard Multimate Type III+ contacts.

Extraction Tool Part No. 305183

Note: Gold-plated contacts should not be mated with tin or silver plated contacts.

[†]To use with the 626 Pneumatic Tool System: remove the crimping head from the Straight Action Hand Tool (SAHT) Assembly, order SAHT Adapter **Part No 217201-1**, Adapter Holder **Part No. 356304-1** (with ratchet) or **189928-1** (without), and Power Unit **Part No. 189721-1** (hand actuated) or **189722-1** (foot actuated).